



4-BIT BIDIRECTIONAL UNIVERSAL SHIFT REGISTER

The MC74F194 is a high-speed 4-bit bidirectional universal shift register. As a high-speed multifunctional, sequential building block, it is useful in a wide variety of applications. It may be used in serial-serial, shift left, shift right, serial-parallel, parallel-serial, and parallel-parallel data register transfers. The F194 is similar in operation to the S195 universal shift register, with added features of shift left without external connections and hold (do nothing) modes of operation.

- Typical Shift Frequency of 150 MHz
- Asynchronous Master Reset
- Hold (Do Nothing) Mode
- Fully Synchronous Serial or Parallel Data Transfers

FUNCTIONAL DESCRIPTION

The F194 contains four edge-triggered D flip-flops and the necessary interstage logic to synchronously perform shift right, shift left, parallel load and hold operations. Signals applied to the Select (S_0 , S_1) inputs determine the type of operation, as shown in the Function Table. Signals on the Select, Parallel data (P_0-P_3) and Serial data (DSR , DSL) inputs can change when the clock is in either state, provided only that the recommended setup and hold times, with respect to the clock rising edge, are observed. A LOW signal on Master Reset (MR) overrides all other inputs and forces the outputs LOW.

CONNECTION DIAGRAM

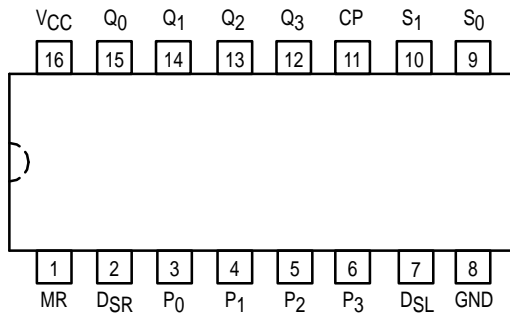

FUNCTION TABLE

Operating Mode	Inputs						Outputs			
	MR	S ₁	S ₀	DSR	DSL	P _n	Q ₀	Q ₁	Q ₂	Q ₃
Reset	L	X	X	X	X	X	L	L	L	L
Hold	H	l	l	X	X	X	q ₀	q ₁	q ₂	q ₃
Shift Left	H	h	l	X	l	X	q ₁	q ₂	q ₃	L
	H	h	l	X	h	X	q ₁	q ₂	q ₃	H
Shift Right	H	l	h	l	X	X	L	q ₀	q ₁	q ₂
	H	l	h	h	X	X	H	q ₀	q ₁	q ₂
Parallel Load	H	h	h	X	X	P _n	P ₀	P ₁	P ₂	P ₃

l = LOW voltage level one setup time prior to the LOW-to-HIGH clock transition.
h = HIGH voltage level one setup time prior to the LOW-to-HIGH clock transition.
P_n, q_n = Lower case letters indicate the state of the referenced input or output one setup time prior to the LOW-to-HIGH clock transition.
H = HIGH Voltage Level
L = LOW Voltage Level
X = Immaterial

MC74F194

4-BIT BIDIRECTIONAL UNIVERSAL SHIFT REGISTER
FAST™ SCHOTTKY TTL

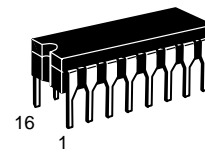

J SUFFIX
CERAMIC
CASE 620-09

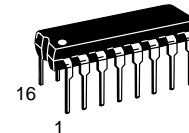

N SUFFIX
PLASTIC
CASE 648-08

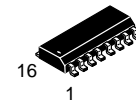

D SUFFIX
SOIC
CASE 751B-03

ORDERING INFORMATION

MC74FXXXJ Ceramic
MC74FXXXN Plastic
MC74FXXXD SOIC

LOGIC SYMBOL

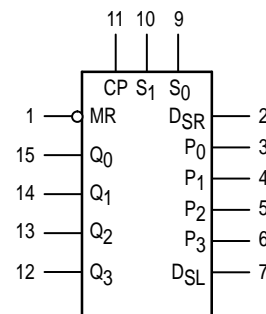

V_{CC} = PIN 16
GND = PIN 8

LIFETIME BUY

LAST SHIP 30/09/99 LAST ORDER 31/03/99

MC74F194

LOGIC DIAGRAM

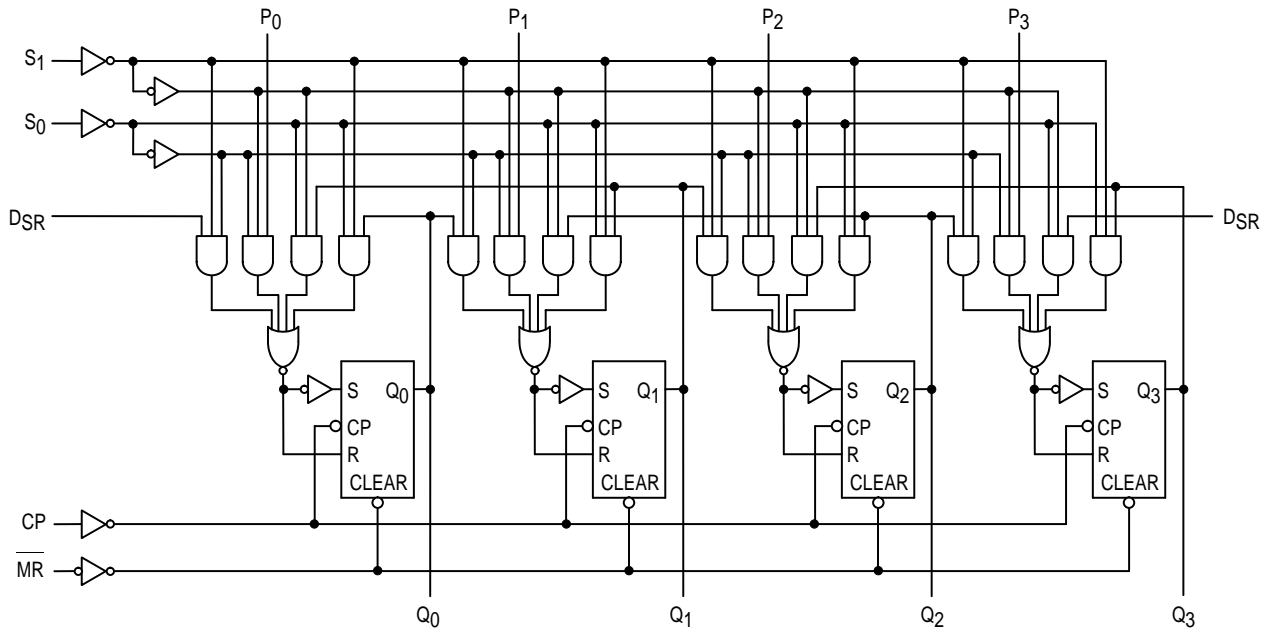

Please note that this diagram is provided only for the understanding of logic operations and should not be used to estimate propagation delays.

GUARANTEED OPERATING RANGES

Symbol	Parameter		Min	Typ	Max	Unit
V _{CC}	Supply Voltage	74	4.5	5.0	5.5	V
T _A	Operating Ambient Temperature Range	74	0	25	70	°C
I _{OH}	Output Current — High	74			-1.0	mA
I _{OL}	Output Current — Low	74			20	mA

DC CHARACTERISTICS OVER OPERATING TEMPERATURE RANGE (unless otherwise specified)

Symbol	Parameter	Limits			Unit	Test Conditions	
		Min	Typ	Max			
V _{IH}	Input HIGH Voltage	2.0			V	Guaranteed Input HIGH Voltage	
V _{IL}	Input LOW Voltage			0.8	V	Guaranteed Input LOW Voltage	
V _{IK}	Input Clamp Diode Voltage			-1.2	V	I _{IN} = -18 mA	V _{CC} = MIN
V _{OH}	Output HIGH Voltage	74	2.5	3.4	V	I _{OH} = -1.0 mA	V _{CC} = 4.5 V
		74	2.7	3.4	V	I _{OH} = -1.0 mA	V _{CC} = 4.75 V
V _{OL}	Output LOW Voltage		0.35	0.5	V	I _{OL} = 20 mA	V _{CC} = MIN
I _{IH}	Input HIGH Current			20	μA	V _{IN} = 2.7 V	V _{CC} = MAX
				100	μA	V _{IN} = 7.0 V	
I _{IL}	Input LOW Current			-0.6	mA	V _{IN} = 0.5 V	V _{CC} = MAX
I _{OS}	Output Short Circuit Current (Note 2)	-60		-150	mA	V _{OUT} = 0 V	V _{CC} = MAX
I _{CC}	Power Supply Current		33	46	mA	S _n , MR, DSR, D _{SL} = 4.5 V P _n = Gnd, CP =	V _{CC} = MAX

NOTES:

- For conditions such as MIN or MAX, use the appropriate value specified under guaranteed operating ranges.
- Not more than one output should be shorted at a time, nor for more than 1 second.

LIFETIME BUY

LAST SHIP 30/09/99
LAST ORDER 31/03/99

MC74F194

AC CHARACTERISTICS

Symbol	Parameter	74F		74F		Unit
		T _A = +25°C V _{CC} = +5.0 V C _L = 50 pF		T _A = 0 to +70°C V _{CC} = 5.0 V ±10% C _L = 50 pF		
		Min	Max	Min	Max	
f _{max}	Maximum Shift Frequency	105		90		MHz
t _{PLH} t _{PHL}	Propagation Delay CP to Q _n	3.0 3.5	7.0 7.5	3.5 3.5	8.0 8.0	ns
t _{PHL}	Propagation Delay MR to Q _n	4.5	12	4.5	14	ns

AC OPERATING REQUIREMENTS

Symbol	Parameter	74F		74F		Unit
		T _A = +25°C V _{CC} = +5.0 V		T _A = 0 to +70°C V _{CC} = 5.0 V ±10%		
		Min	Max	Min	Max	
t _s (H) t _s (L)	Set up Time, HIGH or LOW P _n or D _{SR} or D _{SL} to CP	4.0 4.0		4.0 4.0		ns
t _h (H) t _h (L)	Hold Time, HIGH or LOW P _n or D _{SR} or D _{SL} to CP	0 0		1.0 1.0		
t _s (H) t _s (L)	Set up Time, HIGH or LOW S _n to CP	8.0 8.0		9.0 8.0		ns
t _h (H) t _h (L)	Hold Time, HIGH or LOW S _n to CP	0 0		0 0		
t _w (H)	CP Pulse Width HIGH	5.0		5.5		ns
t _w (L)	MR Pulse Width LOW	5.0		5.0		ns
t _{rec}	Recovery Time MR to CP	7.0		8.0		ns

LIFETIME BUY

LAST SHIP 30/09/99 LAST ORDER 31/03/99

LIFETIME BUY

LAST ORDER 31/03/99 LAST SHIP 30/09/99

Mfax is a trademark of Motorola, Inc.

Motorola reserves the right to make changes without further notice to any products herein. Motorola makes no warranty, representation or guarantee regarding the suitability of its products for any particular purpose, nor does Motorola assume any liability arising out of the application or use of any product or circuit, and specifically disclaims any and all liability, including without limitation consequential or incidental damages. "Typical" parameters which may be provided in Motorola data sheets and/or specifications can and do vary in different applications and actual performance may vary over time. All operating parameters, including "Typicals" must be validated for each customer application by customer's technical experts. Motorola does not convey any license under its patent rights nor the rights of others. Motorola products are not designed, intended, or authorized for use as components in systems intended for surgical implant into the body, or other applications intended to support or sustain life, or for any other application in which the failure of the Motorola product could create a situation where personal injury or death may occur. Should Buyer purchase or use Motorola products for any such unintended or unauthorized application, Buyer shall indemnify and hold Motorola and its officers, employees, subsidiaries, affiliates, and distributors harmless against all claims, costs, damages, and expenses, and reasonable attorney fees arising out of, directly or indirectly, any claim of personal injury or death associated with such unintended or unauthorized use, even if such claim alleges that Motorola was negligent regarding the design or manufacture of the part. Motorola and  are registered trademarks of Motorola, Inc. Motorola, Inc. is an Equal Opportunity/Affirmative Action Employer.

How to reach us:

USA/EUROPE/Locations Not Listed: Motorola Literature Distribution; P.O. Box 5405, Denver, Colorado 80217.
1-303-675-2140 or 1-800-441-2447

JAPAN: Motorola Japan Ltd.; SPS, Technical Information Center, 3-20-1, Minami-Azabu. Minato-ku, Tokyo 106-8573 Japan.
81-3-3440-3569

ASIA/PACIFIC: Motorola Semiconductors H.K. Ltd.; Silicon Harbour Centre, 2 Dai King Street, Tai Po Industrial Estate, Tai Po, N.T., Hong Kong. 852-26668334

Customer Focus Center: 1-800-521-6274

Mfax™: RMFAX0@email.sps.mot.com – TOUCHTONE 1-602-244-6609
Motorola Fax Back System – US & Canada ONLY 1-800-774-1848
– <http://sps.motorola.com/mfax/>

HOME PAGE: <http://motorola.com/sps/>



MOTOROLA

