



FDD6688/FDU6688

# FDD6688/FDU6688

## 30V N-Channel PowerTrench<sup>®</sup> MOSFET

### General Description

This N-Channel MOSFET has been designed specifically to improve the overall efficiency of DC/DC converters using either synchronous or conventional switching PWM controllers. It has been optimized for low gate charge, low  $R_{DS(ON)}$  and fast switching speed.

### Applications

- DC/DC converter
- Motor Drives

### Features

- 84 A, 30 V.  $R_{DS(ON)} = 5\text{ m}\Omega @ V_{GS} = 10\text{ V}$   
 $R_{DS(ON)} = 6\text{ m}\Omega @ V_{GS} = 4.5\text{ V}$
- Low gate charge
- Fast switching
- High performance trench technology for extremely low  $R_{DS(ON)}$

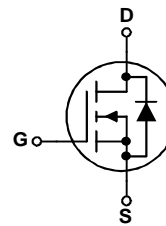
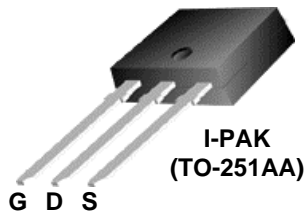
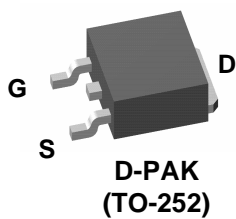

### Absolute Maximum Ratings $T_A=25^\circ\text{C}$ unless otherwise noted

Symbol	Parameter	Ratings	Units
$V_{DSS}$	Drain-Source Voltage	30	V
$V_{GSS}$	Gate-Source Voltage	$\pm 20$	
$I_D$	Drain Current – Continuous (Note 3)	84	A
	– Pulsed (Note 1a)	100	
$P_D$	Power Dissipation for Single Operation (Note 1)	83	W
	(Note 1a)	3.8	
	(Note 1b)	1.6	
$T_J, T_{STG}$	Operating and Storage Junction Temperature Range	$-55$ to $+175$	$^\circ\text{C}$

### Thermal Characteristics

$R_{\theta JC}$	Thermal Resistance, Junction-to-Case (Note 1)	1.8	$^\circ\text{C/W}$
$R_{\theta JA}$	Thermal Resistance, Junction-to-Ambient (Note 1a)	40	
	(Note 1b)	96	

### Package Marking and Ordering Information

Device Marking	Device	Package	Reel Size	Tape width	Quantity
FDD6688	FDD6688	D-PAK (TO-252)	13"	16mm	2500 units
FDU6688	FDU6688	I-PAK (TO-251)	Tube	N/A	75

## Electrical Characteristics

$T_A = 25^\circ\text{C}$  unless otherwise noted

Symbol	Parameter	Test Conditions	Min	Typ	Max	Units
--------	-----------	-----------------	-----	-----	-----	-------

### Drain-Source Avalanche Ratings (Note 2)

$W_{DSS}$	Drain-Source Avalanche Energy	Single Pulse, $V_{DD} = 15\text{ V}$ , $I_D = 21\text{ A}$			370	mJ
$I_{AR}$	Drain-Source Avalanche Current				21	A

### Off Characteristics

$BV_{DSS}$	Drain-Source Breakdown Voltage	$V_{GS} = 0\text{ V}$ , $I_D = 250\ \mu\text{A}$	30			V
$\frac{\Delta BV_{DSS}}{\Delta T_J}$	Breakdown Voltage Temperature Coefficient	$I_D = 250\ \mu\text{A}$ , Referenced to $25^\circ\text{C}$		24		mV/ $^\circ\text{C}$
$I_{DSS}$	Zero Gate Voltage Drain Current	$V_{DS} = 24\text{ V}$ , $V_{GS} = 0\text{ V}$			1	$\mu\text{A}$
$I_{GSS}$	Gate-Body Leakage	$V_{GS} = \pm 20\text{ V}$ , $V_{DS} = 0\text{ V}$			$\pm 100$	nA

### On Characteristics (Note 2)

$V_{GS(th)}$	Gate Threshold Voltage	$V_{DS} = V_{GS}$ , $I_D = 250\ \mu\text{A}$	1	1.8	3	V
$\frac{\Delta V_{GS(th)}}{\Delta T_J}$	Gate Threshold Voltage Temperature Coefficient	$I_D = 250\ \mu\text{A}$ , Referenced to $25^\circ\text{C}$		-5		mV/ $^\circ\text{C}$
$R_{DS(on)}$	Static Drain-Source On-Resistance	$V_{GS} = 10\text{ V}$ , $I_D = 18\text{ A}$ $V_{GS} = 4.5\text{ V}$ , $I_D = 16.5\text{ A}$ $V_{GS} = 10\text{ V}$ , $I_D = 18\text{ A}$ , $T_J = 125^\circ\text{C}$		4 5 6	5 6 10	m $\Omega$
$I_{D(on)}$	On-State Drain Current	$V_{GS} = 10\text{ V}$ , $V_{DS} = 5\text{ V}$	50			A
$g_{FS}$	Forward Transconductance	$V_{DS} = 5\text{ V}$ , $I_D = 18\text{ A}$		88		S

### Dynamic Characteristics

$C_{iss}$	Input Capacitance	$V_{DS} = 15\text{ V}$ , $V_{GS} = 0\text{ V}$ ,		3845		pF
$C_{oss}$	Output Capacitance	$f = 1.0\text{ MHz}$		930		pF
$C_{rss}$	Reverse Transfer Capacitance			368		pF
$R_G$	Gate Resistance	$V_{GS} = 15\text{ mV}$ , $f = 1.0\text{ MHz}$		1.2		$\Omega$

### Switching Characteristics (Note 2)

$t_{d(on)}$	Turn-On Delay Time	$V_{DD} = 15\text{ V}$ , $I_D = 1\text{ A}$ ,		15	27	ns
$t_r$	Turn-On Rise Time	$V_{GS} = 10\text{ V}$ , $R_{GEN} = 6\ \Omega$		13	23	ns
$t_{d(off)}$	Turn-Off Delay Time			62	99	ns
$t_f$	Turn-Off Fall Time			36	58	ns
$Q_g$	Total Gate Charge	$V_{DS} = 15\text{ V}$ , $I_D = 18\text{ A}$ ,		37	56	nC
$Q_{gs}$	Gate-Source Charge	$V_{GS} = 5\text{ V}$		10		nC
$Q_{gd}$	Gate-Drain Charge			14		nC

**Electrical Characteristics** (continued) T<sub>A</sub> = 25°C unless otherwise noted

Symbol	Parameter	Test Conditions	Min	Typ	Max	Units
<b>Drain–Source Diode Characteristics and Maximum Ratings</b>						
V <sub>SD</sub>	Drain–Source Diode Forward Voltage	V <sub>GS</sub> = 0 V, I <sub>S</sub> = 3.2 A (Note 2)		0.7	1.2	V
t <sub>rr</sub>	Diode Reverse Recovery Time	I <sub>F</sub> = 18 A, d <sub>iF</sub> /d <sub>t</sub> = 100 A/μs		39		nS
Q <sub>rr</sub>	Diode Reverse Recovery Charge			31		nC

**Notes:8**

- R<sub>θJA</sub> is the sum of the junction-to-case and case-to-ambient thermal resistance where the case thermal reference is defined as the solder mounting surface of the drain pins. R<sub>θJC</sub> is guaranteed by design while R<sub>θCA</sub> is determined by the user's board design.

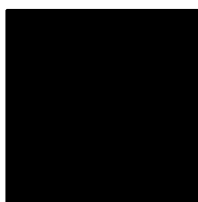

a) R<sub>θJA</sub> = 40°C/W when mounted on a 1in<sup>2</sup> pad of 2 oz copper



b) R<sub>θJA</sub> = 96°C/W when mounted on a minimum pad.

Scale 1 : 1 on letter size paper

- Pulse Test: Pulse Width < 300μs, Duty Cycle < 2.0%

- Maximum current is calculated as: 
$$\sqrt{\frac{P_D}{R_{DS(ON)}}}$$

where P<sub>D</sub> is maximum power dissipation at T<sub>C</sub> = 25°C and R<sub>DS(on)</sub> is at T<sub>J(max)</sub> and V<sub>GS</sub> = 10V. Package current limitation is 21A

## Typical Characteristics

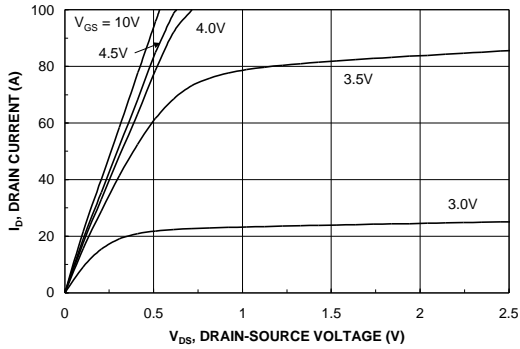

Figure 1. On-Region Characteristics.

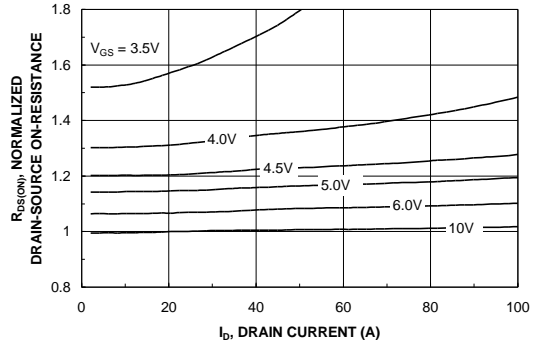

Figure 2. On-Resistance Variation with Drain Current and Gate Voltage.

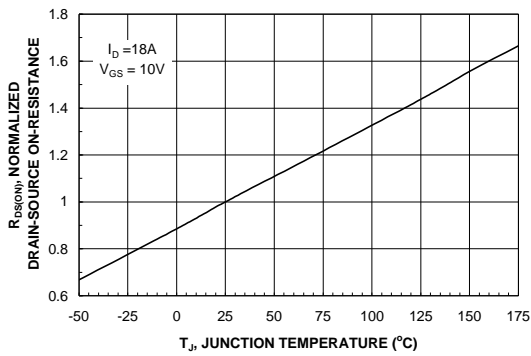

Figure 3. On-Resistance Variation with Temperature.

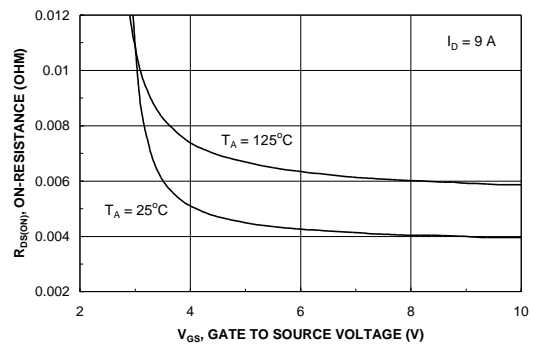

Figure 4. On-Resistance Variation with Gate-to-Source Voltage.

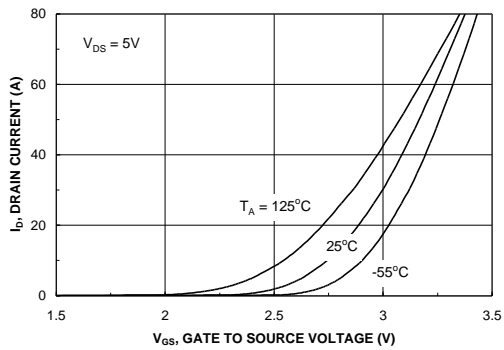

Figure 5. Transfer Characteristics

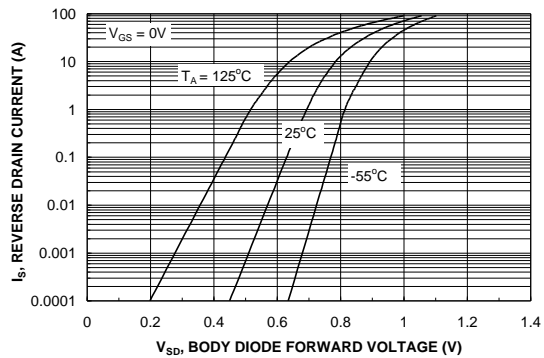

Figure 6. Body Diode Forward Voltage Variation with Source Current and Temperature

### Typical Characteristics

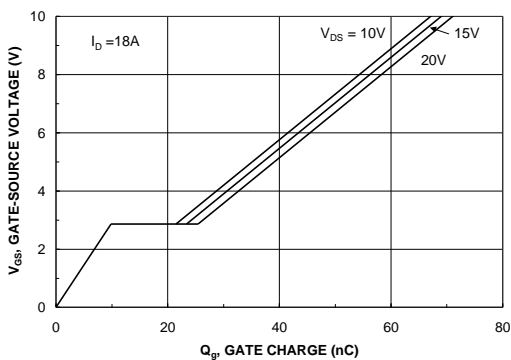

Figure 7. Gate Charge Characteristics

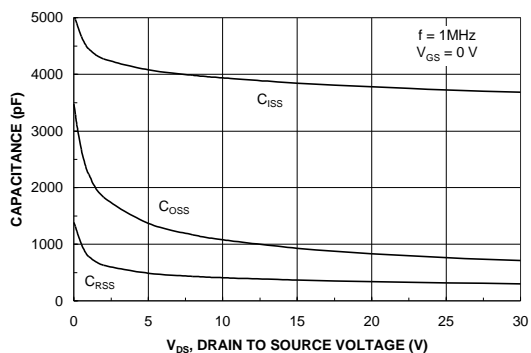

Figure 8. Capacitance Characteristics

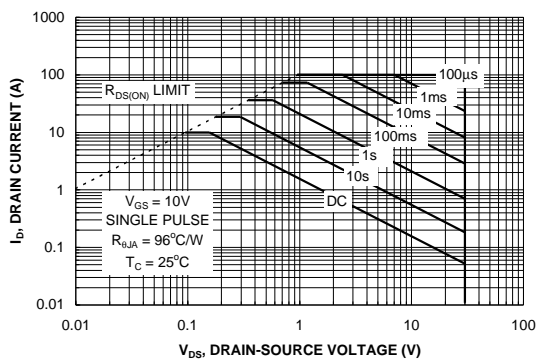

Figure 9. Maximum Safe Operating Area

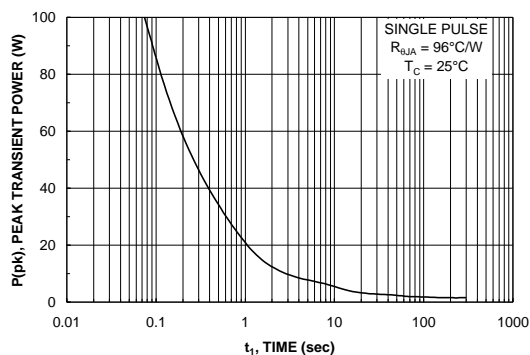

Figure 10. Single Pulse Maximum Power Dissipation

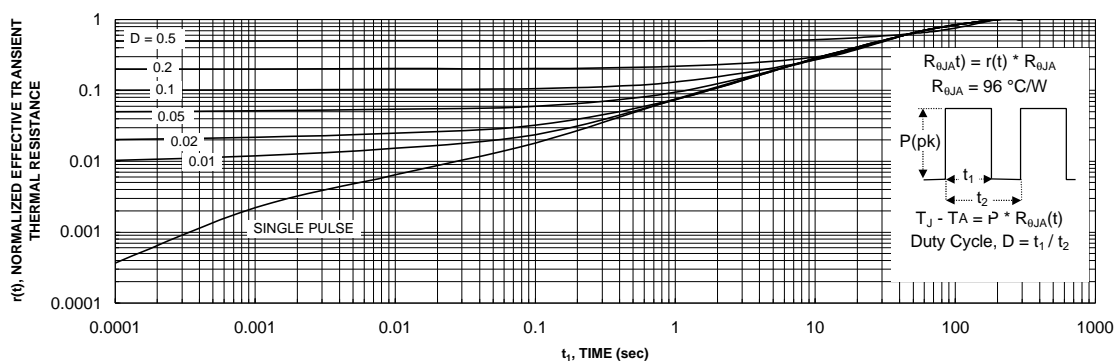
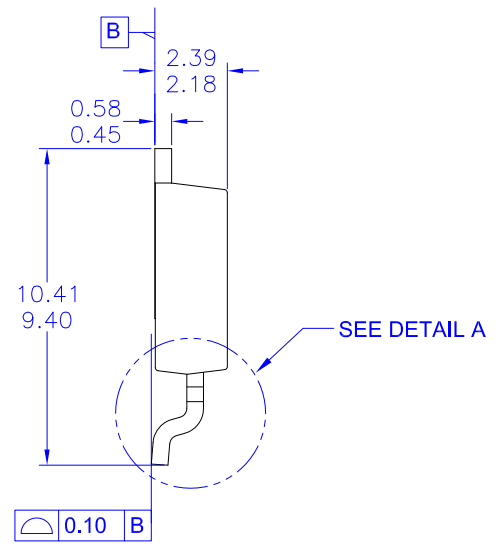
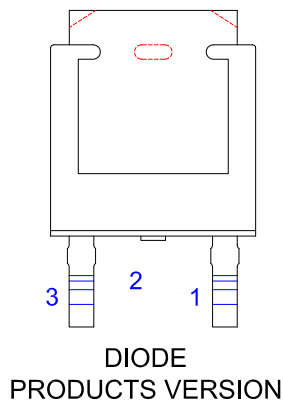
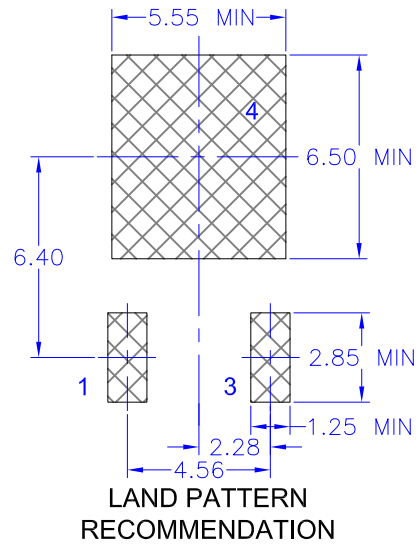

Figure 11. Transient Thermal Response Curve

Thermal characterization performed using the conditions described in Note 1b. Transient thermal response will change depending on the circuit board design.



NOTES: UNLESS OTHERWISE SPECIFIED

- A) THIS PACKAGE CONFORMS TO JEDEC, TO-252, ISSUE C, VARIATION AA.
- B) ALL DIMENSIONS ARE IN MILLIMETERS.
- C) DIMENSIONING AND TOLERANCING PER ASME Y14.5M-2009.
- D) SUPPLIER DEPENDENT MOLD LOCKING HOLES OR CHAMFERED CORNERS OR EDGE PROTRUSION.
- E) TRIMMED METAL CENTER LEAD IS PRESENT ON FOR NON-DIODE PRODUCTS
- F) DIMENSIONS ARE EXCLUSIVE OF BURS, MOLD FLASH AND TIE BAR EXTRUSIONS.
- G) LAND PATTERN RECOMMENDATION IS BASED ON IPC7351A STD TO228P991X239-3N.
- H) DRAWING NUMBER AND REVISION: MKT-TO252A03REV11

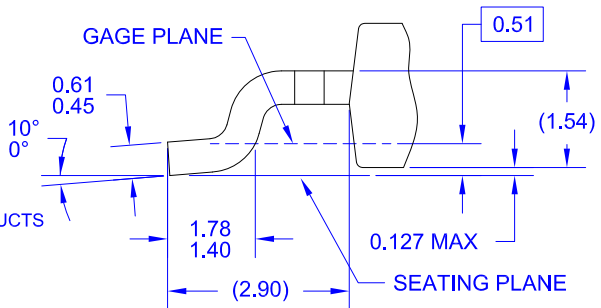





DETAIL A  
(ROTATED -90°)  
SCALE: 12X





**TRADEMARKS**

The following includes registered and unregistered trademarks and service marks, owned by Fairchild Semiconductor and/or its global subsidiaries, and is not intended to be an exhaustive list of all such trademarks.

- |   |  |   |   |
|---|--|---|---|
| AccuPower™  | F-PFS™   | OPTOPLANAR®   |  |
| AttitudeEngine™   | FRFET®   |  | TinyBoost®  |
| Awinda®   | Global Power Resource <sup>SM</sup>            | Power Supply WebDesigner™   | TinyBuck®   |
| AX-CAP®*  | GreenBridge™                                   | PowerTrench®  | TinyCalc™   |
| BitSiC™   | Green FPS™                                     | PowerXS™  | TinyLogic®  |
| Build it Now™   | Green FPS™ e-Series™                           | Programmable Active Droop™  | TINYOPTO™   |
| CorePLUS™   | Gmax™  | QFET®   | TinyPower™  |
| CorePOWER™  | GTO™   | QS™   | TinyPWM™  |
| CROSSVOL™   | IntelliMAX™                                    | Quiet Series™   | TinyWire™   |
| CTL™  | ISOPLANAR™                                     | RapidConfigure™   | TranSiC™  |
| Current Transfer Logic™   | Making Small Speakers Sound Louder and Better™ |  | TriFault Detect™  |
| DEUXPEED®   | MegaBuck™                                      | Saving our world, 1mW/W/kW at a time™   | TRUECURRENT®*   |
| Dual Cool™  | MICROCOUPLER™                                  | SignalWise™   | μSerDes™  |
| EcoSPARK®   | MicroFET™                                      | SmartMax™   |  |
| EfficientMax™   | MicroPak™                                      | SMART START™  | UHC®  |
| ESBC™   | MicroPak2™                                     | Solutions for Your Success™   | Ultra FRFET™  |
|  | MillerDrive™                                   | SPM®  | UniFET™   |
| Fairchild®  | MotionMax™                                     | STEALTH™  | VCX™  |
| Fairchild Semiconductor®  | MotionGrid®                                    | SuperFET®   | VisualMax™  |
| FACT Quiet Series™  | MTi®   | SuperSOT™-3   | VoltagePlus™  |
| FACT®   | MTx®   | SuperSOT™-6   | XS™   |
| FastvCore™  | MVN®   | SuperSOT™-8   | Xsens™  |
| FETBench™   | mWSaver®                                       | SupreMOS®   | 仙童®   |
| FPS™  | OptoHiT™                                       | SyncFET™  |   |
|   | OPTOLOGIC®                                     | Sync-Lock™  |   |

\* Trademarks of System General Corporation, used under license by Fairchild Semiconductor.

**DISCLAIMER**

FAIRCHILD SEMICONDUCTOR RESERVES THE RIGHT TO MAKE CHANGES WITHOUT FURTHER NOTICE TO ANY PRODUCTS HEREIN TO IMPROVE RELIABILITY, FUNCTION, OR DESIGN. TO OBTAIN THE LATEST, MOST UP-TO-DATE DATASHEET AND PRODUCT INFORMATION, VISIT OUR WEBSITE AT [HTTP://WWW.FAIRCHILDSEMI.COM](http://www.fairchildsemi.com). FAIRCHILD DOES NOT ASSUME ANY LIABILITY ARISING OUT OF THE APPLICATION OR USE OF ANY PRODUCT OR CIRCUIT DESCRIBED HEREIN; NEITHER DOES IT CONVEY ANY LICENSE UNDER ITS PATENT RIGHTS, NOR THE RIGHTS OF OTHERS. THESE SPECIFICATIONS DO NOT EXPAND THE TERMS OF FAIRCHILD'S WORLDWIDE TERMS AND CONDITIONS, SPECIFICALLY THE WARRANTY THEREIN, WHICH COVERS THESE PRODUCTS.

**AUTHORIZED USE**

Unless otherwise specified in this data sheet, this product is a standard commercial product and is not intended for use in applications that require extraordinary levels of quality and reliability. This product may not be used in the following applications, unless specifically approved in writing by a Fairchild officer: (1) automotive or other transportation, (2) military/aerospace, (3) any safety critical application – including life critical medical equipment – where the failure of the Fairchild product reasonably would be expected to result in personal injury, death or property damage. Customer's use of this product is subject to agreement of this Authorized Use policy. In the event of an unauthorized use of Fairchild's product, Fairchild accepts no liability in the event of product failure. In other respects, this product shall be subject to Fairchild's Worldwide Terms and Conditions of Sale, unless a separate agreement has been signed by both Parties.

**ANTI-COUNTERFEITING POLICY**

Fairchild Semiconductor Corporation's Anti-Counterfeiting Policy. Fairchild's Anti-Counterfeiting Policy is also stated on our external website, [www.fairchildsemi.com](http://www.fairchildsemi.com), under Terms of Use

Counterfeiting of semiconductor parts is a growing problem in the industry. All manufacturers of semiconductor products are experiencing counterfeiting of their parts. Customers who inadvertently purchase counterfeit parts experience many problems such as loss of brand reputation, substandard performance, failed applications, and increased cost of production and manufacturing delays. Fairchild is taking strong measures to protect ourselves and our customers from the proliferation of counterfeit parts. Fairchild strongly encourages customers to purchase Fairchild parts either directly from Fairchild or from Authorized Fairchild Distributors who are listed by country on our web page cited above. Products customers buy either from Fairchild directly or from Authorized Fairchild Distributors are genuine parts, have full traceability, meet Fairchild's quality standards for handling and storage and provide access to Fairchild's full range of up-to-date technical and product information. Fairchild and our Authorized Distributors will stand behind all warranties and will appropriately address any warranty issues that may arise. Fairchild will not provide any warranty coverage or other assistance for parts bought from Unauthorized Sources. Fairchild is committed to combat this global problem and encourage our customers to do their part in stopping this practice by buying direct or from authorized distributors.

**PRODUCT STATUS DEFINITIONS**

**Definition of Terms**

Datasheet Identification	Product Status	Definition
Advance Information	Formative / In Design	Datasheet contains the design specifications for product development. Specifications may change in any manner without notice.
Preliminary	First Production	Datasheet contains preliminary data; supplementary data will be published at a later date. Fairchild Semiconductor reserves the right to make changes at any time without notice to improve design.
No Identification Needed	Full Production	Datasheet contains final specifications. Fairchild Semiconductor reserves the right to make changes at any time without notice to improve the design.
Obsolete	Not In Production	Datasheet contains specifications on a product that is discontinued by Fairchild Semiconductor. The datasheet is for reference information only.