

## Quad EIA-485 Line Receiver

The Motorola SN75175 is a monolithic quad differential line receiver with three-state outputs. It is designed specifically to meet the requirements of EIA-485, EIA-422A/23A Standards and CCITT recommendations.

The device is optimized for balanced multipoint bus transmission at rates up to 10 megabits per second. It also features high input impedance, input hysteresis for increased noise immunity, and input sensitivity of  $\pm 200$  mV over a common mode input voltage range of  $-12$  V to  $12$  V. The SN75175 is designed for optimum performance when used with the SN75172 or SN75174 quad differential line drivers.

- Meets EIA Standards EIA-422A and EIA-423A, EIA-485
- Meets CCITT Recommendations V.10, V.11, X.26, and X.27
- Designed for Multipoint Transmission on Long Bus Lines in Noisy Environments
- 3-State Outputs
- Common-Mode Input Voltage Range . . .  $-12$  V to  $12$  V
- Input Sensitivity . . .  $\pm 200$  mV
- Input Hysteresis . . . 50 mV Typ
- High Input Impedance . . . 1 EIA-485 Unit Load
- Operates from Single 5.0 V Supply
- Lower Power Requirements
- Plug-In Replacement for MC3486

This device contains 174 active transistors.

### MAXIMUM RATINGS

Rating	Symbol	Value	Unit
Power Supply Voltage	$V_{CC}$	7.0	Vdc
Input Common Mode Voltage	$V_{ICM}$	$\pm 25$	Vdc
Input Differential Voltage	$V_{ID}$	$\pm 25$	Vdc
Three-State Control Input Voltage	$V_I$	7.0	Vdc
Output Sink Current	$I_O$	50	mA
Storage Temperature	$T_{stg}$	$-65$ to $+150$	$^{\circ}C$
Operating Junction Temperature	$T_J$	$+150$	$^{\circ}C$

**NOTE:** ESD data available upon request.

### RECOMMENDED OPERATING CONDITIONS

Rating	Symbol	Value	Unit
Power Supply Voltage	$V_{CC}$	4.75 to 5.25	Vdc
Operating Ambient Temperature	$T_A$	0 to $+70$	$^{\circ}C$
Input Common Mode Voltage Range	$V_{ICM}$	$-12$ to $+12$	Vdc
Input Differential Voltage Range	$V_{IDR}$	$-12$ to $+12$	Vdc

## SN75175

### QUAD EIA-485 LINE RECEIVER WITH THREE-STATE OUTPUTS

#### SEMICONDUCTOR TECHNICAL DATA



**N SUFFIX**  
PLASTIC PACKAGE  
CASE 648

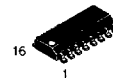

**D SUFFIX**  
PLASTIC PACKAGE  
CASE 751B  
(SO-16)

7

### PIN CONNECTIONS

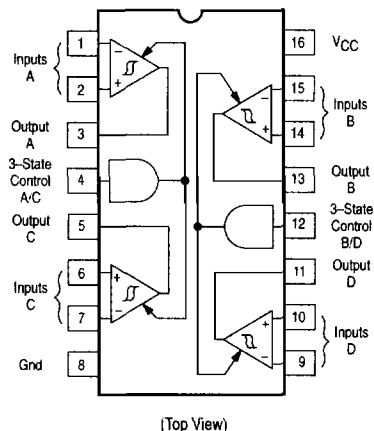

### ORDERING INFORMATION

Device	Operating Temperature Range	Package
SN75175N	$T_A = 0$ to $+70^{\circ}C$	Plastic DIP
SN75175D		SO-16

# SN75175

**ELECTRICAL CHARACTERISTICS** (Unless otherwise noted, minimum and maximum limits apply over recommended temperature and power supply voltage ranges. Typical values are for  $T_A = 25^\circ\text{C}$ ,  $V_{CC} = 5.0\text{ V}$ , and  $V_{ICM} = 0\text{ V}$ , Note 1.)

Characteristic	Symbol	Min	Typ	Max	Unit
Differential Input Threshold Voltage (Note 2) ( $-12\text{ V} \leq V_{ICM} \leq 12\text{ V}$ , $V_{IH} = 2.0\text{ V}$ ) ( $I_O = -0.4\text{ mA}$ , $V_{OH} \geq 2.7\text{ V}$ ) ( $I_O = 16\text{ mA}$ , $V_{OL} \leq 0.5\text{ V}$ )	$V_{TH(D)}$	–	–	0.2 –0.2	V
Input Hysteresis	$V_{T+} - V_{T-}$	–	50	–	mV
Input Line Current (Differential Inputs) (Unmeasured Input at 0 V, Note 3) ( $V_I = 12\text{ V}$ ) ( $V_I = -7.0\text{ V}$ )	$I_I$	–	–	1.0 –0.8	mA
Input Resistance (Note 4)	$r_i$	1 Unit Load	–	–	
Input Balance and Output Level (Note 3) ( $-12\text{ V} \leq V_{ICM} \leq 12\text{ V}$ , $V_{IH} = 2.0\text{ V}$ ) ( $I_O = -0.4\text{ mA}$ , $V_{ID} = 0.2\text{ V}$ ) ( $I_O = 8.0\text{ mA}$ , $V_{ID} = -0.2\text{ V}$ ) ( $I_O = 16\text{ mA}$ , $V_{ID} = -0.2\text{ V}$ )	$V_{OH}$ $V_{OL}$ $V_{OL}$	2.7 – –	– – –	– 0.45 0.5	V
Input Voltage – High Logic State (Three-State Control)	$V_{IH}$	2.0	–	–	V
Input Voltage – Low Logic State (Three-State Control)	$V_{IL}$	–	–	0.8	V
Input Current – High Logic State (Three-State Control) ( $V_{IH} = 2.7\text{ V}$ ) ( $V_{IH} = 5.5\text{ V}$ )	$I_{IH}$	–	–	20 100	$\mu\text{A}$
Input Current – Low Logic State (Three-State Control) ( $V_{IL} = 0.4\text{ V}$ )	$I_{IL}$	–	–	–100	$\mu\text{A}$
Input Clamp Diode Voltage (Three-State Control) ( $I_{IK} = -18\text{ mA}$ )	$V_{IK}$	–	–	–1.5	V
Output Third State Leakage Current ( $V_{I(D)} = 3.0\text{ V}$ , $V_{IL} = 0.8\text{ V}$ , $V_O = 0.4\text{ V}$ ) ( $V_{I(D)} = -3.0\text{ V}$ , $V_{IL} = 0.8\text{ V}$ , $V_O = 2.4\text{ V}$ )	$I_{OZ}$	–	–	–20 20	$\mu\text{A}$
Output Short-Circuit Current (Note 5) ( $V_{I(D)} = 3.0\text{ V}$ , $V_{IH} = 2.0\text{ V}$ , $V_O = 0\text{ V}$ )	$I_{OS}$	–15	–	–85	mA
Power Supply Current ( $V_{IL} = 0\text{ V}$ ) (All Inputs Grounded)	$I_{CC}$	–	–	70	mA

- NOTES:**
1. All currents into device pins are shown as positive, out of device pins are negative. All voltages referenced to ground unless otherwise noted.
  2. Differential input threshold voltage and guaranteed output levels are done simultaneously for worst case.
  3. Refer to EIA-485 for exact conditions. Input balance and guaranteed output levels are done simultaneously for worst case.
  4. Input resistance should be derived from input line current specifications and is shown for reference only. See EIA-485 and input line current specifications for more specific input resistance information.
  5. Only one output at a time should be shorted.

**SWITCHING CHARACTERISTICS** (Unless otherwise noted,  $V_{CC} = 5.0\text{ V}$  and  $T_A = 25^\circ\text{C}$ .)

Characteristic	Symbol	Min	Typ	Max	Unit
Propagation Delay Time – Differential Inputs to Output Output High to Low Output Low to High	$t_{PHL(D)}$ $t_{PLH(D)}$	– –	25 25	35 35	ns
Propagation Delay Time – Three-State Control to Output Output Low to Third State Output High to Third State Output Third State to High Output Third State to Low	$t_{PLZ}$ $t_{PHZ}$ $t_{PZH}$ $t_{PZL}$	– – – –	16 19 11 11	35 35 30 30	ns

# SN75175

**FUNCTION TABLE (EACH RECEIVER)**

Differential Inputs	3-State Control	Output Y
$V_{ID} \geq 2.0 \text{ V}$	H	H
$-0.2 \text{ V} < V_{ID} < 0.2 \text{ V}$	H	?
$V_{ID} \leq -0.2 \text{ V}$	H	L
X	L	Z

H = high level  
L = low level  
X = irrelevant

? = indeterminate  
Z = high-impedance (off)

## SWITCHING TEST CIRCUIT AND WAVEFORMS

**Figure 1. Propagation Delay, Differential Input to Output**

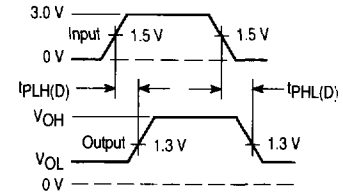
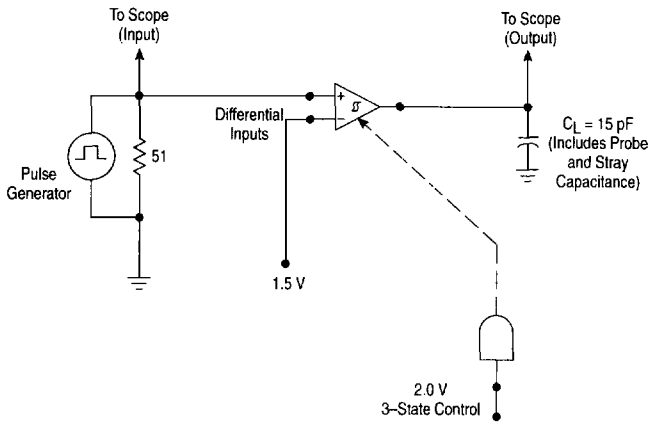

Input Pulse Characteristics -  
 $t_{TLH} = t_{THL} = 6.0 \text{ ns}$  (10% to 90%)  
 PRR = 1.0 MHz, 50% Duty Cycle

# SN75175

## SWITCHING TEST CIRCUIT AND WAVEFORMS (continued)

Figure 2. Propagation Delay, Three-State Control Input to Output

Input Pulse Characteristics -  
 $t_{TLH} = t_{THL} = 6.0 \text{ ns}$  (10% to 90%)  
 PRR = 1.0 MHz, 50% Duty Cycle

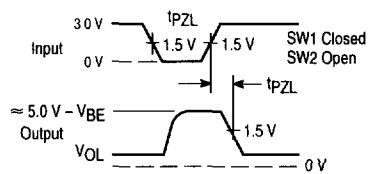
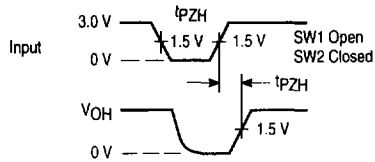
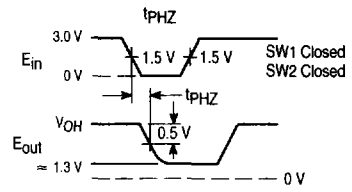
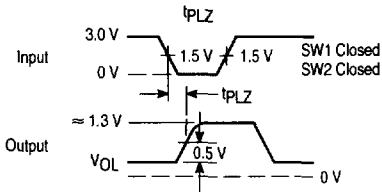
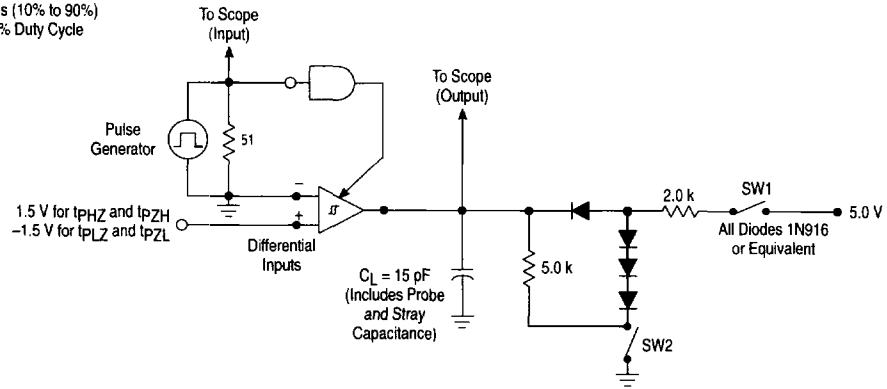

# SN75175

## TYPICAL CHARACTERISTICS

**Figure 3. Output Voltage versus Differential Input Voltage**

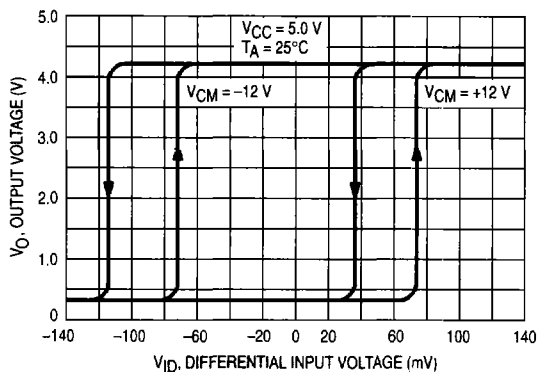

**Figure 4. Output Voltage versus 3-State Control Voltage**

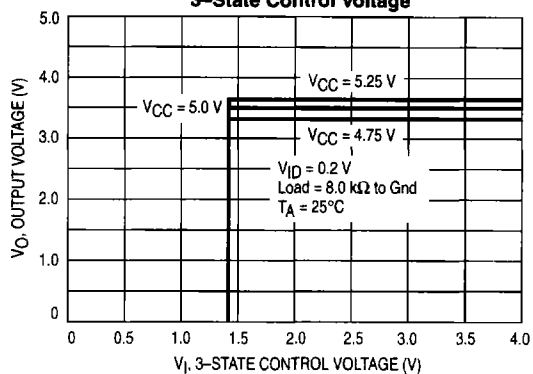

**Figure 5. High Level Output Voltage versus Output Current**

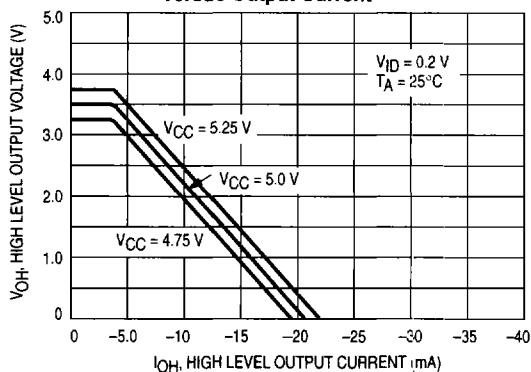

**Figure 6. Low Level Output Voltage versus Output Current**

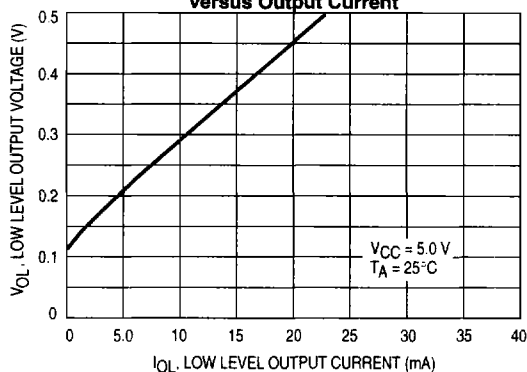

**Figure 7. High Level Output Voltage versus Temperature**

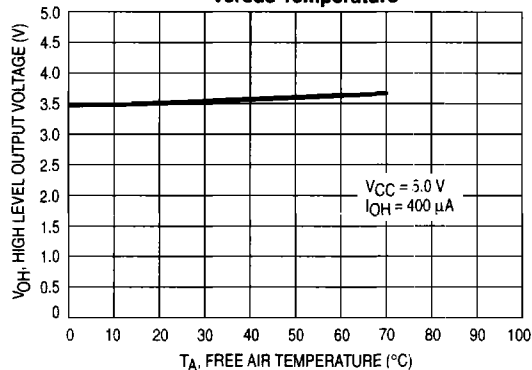

**Figure 8. Low Level Output Voltage versus Temperature**

