

## RMPA5251

### 4.90–5.85 GHz InGaP HBT Linear Power Amplifier

#### General Description

The RMPA5251 power amplifier is designed for high performance WLAN applications in the 4.9 to 5.35 and 5.15 to 5.85 GHz frequency bands. The low profile 16 pin 3 x 3 x 0.9 mm package with internal matching on both input and output to 50Ω minimizes next level PCB space and allows for simplified integration. The on-chip detector provides power sensing capability while the logic control provides power saving shutdown options. The PA's low power consumption and excellent linearity are achieved using our InGaP Heterojunction Bipolar Transistor (HBT) technology.

#### Features

- 4.9 to 5.85 GHz Operation
- 27dB small signal gain
- 26dBm output power @ 1dB compression

- 2.5% EVM at 18.0dBm modulated power out
- 3.3V single positive supply operation
- Adjustable bias current operation
- Two power saving shutdown options (bias and logic control)
- Integrated power detector with >18dB dynamic range
- Low profile 16 pin 3 x 3 x 0.9 mm standard QFN leadless package
- Internally matched to 50Ω
- Minimal external components
- Optimized for use in IEEE 802.11a WLAN applications

#### Device



### Electrical Characteristics<sup>1,3</sup> 802.11a OFDM

Modulation (with 176ms burst time, 100ms idle time) 54Mbps Data Rate, 16.7 MHz Bandwidth

| Parameter   | Minimum | Typical | Maximum | Minimum | Typical | Maximum | Unit |
|---|---------|---------|---------|---------|---------|---------|------|
| Frequency <sup>10</sup>                                   | 4.90    |         | 5.35    | 5.15    |         | 5.85    | GHz  |
| Supply Voltage  | 3.0     | 3.3     | 3.6     | 3.0     | 3.3     | 3.6     | V    |
| Gain  |         | 27      |         |         | 28      |         | dB   |
| Total Current @ 18dBm P <sub>OUT</sub>                    |         | 250     |         |         | 240     |         | mA   |
| Total Current @ 19dBm P <sub>OUT</sub>                    |         | 260     |         |         | 250     |         | mA   |
| EVM @ 18dBm P <sub>OUT</sub> <sup>2</sup>                 |         | 2.5     |         |         | 2.5     |         | %    |
| EVM @ 19dBm P <sub>OUT</sub> <sup>2</sup>                 |         | 3.5     |         |         | 3.5     |         | %    |
| Detector Output @ 19dBm P <sub>OUT</sub>                  |         | 450     |         |         | 500     |         | mV   |
| Detector Threshold <sup>4</sup>                           |         | 5.0     |         |         | 5.0     |         | dBm  |
| P <sub>OUT</sub> Spectral Mask Compliance <sup>5, 6</sup> |         | 21.0    |         |         | 20.0    |         | dBm  |

### Electrical Characteristics<sup>1</sup> Single Tone

| Parameter                                | Minimum | Typical | Maximum | Minimum | Typical | Maximum | Unit |
|--|---------|---------|---------|---------|---------|---------|------|
| Frequency <sup>10</sup>                  | 4.90    |         | 5.35    | 5.15    |         | 5.85    | GHz  |
| Supply Voltage                           | 3.0     | 3.3     | 3.6     | 3.0     | 3.3     | 3.6     | V    |
| Gain <sup>7</sup>                        |         | 27      |         |         | 27.5    |         | dB   |
| Total Quiescent Current <sup>7, 11</sup> |         | 140–220 |         |         | 140–220 |         | mA   |

#### Notes:

1. VC1, VC2, VC3, VM1, VM2, VM3 = 3.3 Volts, T<sub>c</sub>=25°C, PA is constantly biased, 50Ω system.
2. Percentage includes system noise floor of EVM=0.8%.
3. Not measured 100% in production.
4. P<sub>OUT</sub> measured at P<sub>IN</sub> corresponding to power detection threshold.
5. Measured at P<sub>IN</sub> at which Spectral Mask Compliance is satisfied. Two-sample windowing length applied.
6. P<sub>IN</sub> is adjusted to point where performance approaches spectral mask requirements.
7. 100% Production screened.
8. Bias Current is included in the total quiescent current.
9. VL is set to logic level for device off operation.
10. See Application information on Page 3.
11. See Data on Page 8.

## Electrical Characteristics<sup>12</sup> Single Tone (Continued)

| Parameter   | Minimum | Typical | Maximum | Minimum | Typical | Maximum | Unit |
|---|---------|---------|---------|---------|---------|---------|------|
| Bias Current at pin VM <sup>8</sup>                 |         | 16      |         |         | 16      |         | mA   |
| P1dB Compression <sup>7</sup>                       |         | 26      |         |         | 26      |         | dBm  |
| Current @ P1dB Comp <sup>7</sup>                    |         | 425     |         |         | 425     |         | mA   |
| Standby Current <sup>9</sup>                        |         | 1.9     |         |         | 1.9     |         | mA   |
| Shutdown Current (VM=0V)                            |         | <1.0    |         |         | <1.0    |         | μA   |
| Input Return Loss                                   |         | 12      |         |         | 16      |         | dB   |
| Output Return Loss                                  |         | 10      |         |         | 10      |         | dB   |
| Detector Output at P1dB Comp                        |         | 2       |         |         | 2       |         | V    |
| Detector P <sub>OUT</sub> Threshold <sup>3, 4</sup> |         | 7.0     |         |         | 7.0     |         | dBm  |
| Frequency   | 4.90    |         | 5.35    | 5.15    |         | 5.85    | GHz  |
| 2 <sup>nd</sup> Harmonic Output at P1dB             |         | -30     |         |         | -30     |         | dBc  |
| 3rd Harmonic Output at P1dB                         |         | -35     |         |         | -35     |         | dBc  |
| Logic Shutdown Control Pin (VL):                    |         |         |         |         |         |         |      |
| Device Off  |         | 0.0     | 0.8     |         | 0.0     | 0.8     | V    |
| Device On   | 2.0     | 2.4     |         | 2.0     | 2.4     |         | V    |
| Logic Current                                       |         | 10      |         |         | 100     |         | μA   |
| Turn-on Time <sup>13</sup>                          |         | <1      |         |         | <1      |         | μS   |
| Turn-off Time                                       |         | <1      |         |         | <1      |         | μS   |
| Spurious (Stability) <sup>14</sup>                  |         | -65     |         |         | -65     |         | dBc  |

## Absolute Ratings<sup>15</sup>

| Symbol            | Parameter                  | Value       | Units |
|-------------------|----------------------------|-------------|-------|
| VC1, VC2          | Positive Supply Voltage    | 4.0         | V     |
| IC1-IC3           | Supply Current             |             |       |
|                   | IC1                        | 50          | mA    |
|                   | IC2                        | 150         | mA    |
|                   | IC3                        | 500         | mA    |
| VM                | Voltage Mirror             | 4           | V     |
| V <sub>L</sub>    | Logic Voltage              | 5           | V     |
| P <sub>IN</sub>   | RF Input Power             | 10          | dBm   |
| T <sub>CASE</sub> | Case Operating Temperature | -40 to +85  | °C    |
| T <sub>STG</sub>  | Storage Temperature        | -55 to +150 | °C    |

**Notes:**

3. Not measured 100% in production.
4. P<sub>OUT</sub> measured at P<sub>IN</sub> corresponding to power detection threshold.
5. Measured at P<sub>IN</sub> at which Spectral Mask Compliance is satisfied. Two-sample windowing length applied.
6. P<sub>IN</sub> is adjusted to point where performance approaches spectral mask requirements.
7. 100% Production screened.
8. Bias Current is included in the total quiescent current.
9. VL is set to logic level for device off operation.
10. See Application information on Page 3.
11. See Data on Page 8.
12. VC1, VC2, VC3, VM1, VM2, VM3 = 3.3 Volts, T<sub>c</sub>=25°C, PA is constantly biased, 50Ω system
13. Measured from Device On signal turn on, (Logic High) to the point where RF POUT stabilizes to 0.5dB.
14. Load VSWR is set to 8:1 and the angle is varied 360 degrees. POUT = -30dBm to P1dB.
15. No permanent damage with only one parameter set at extreme limit. Other parameters set to typical values.

## Functional Block Diagram

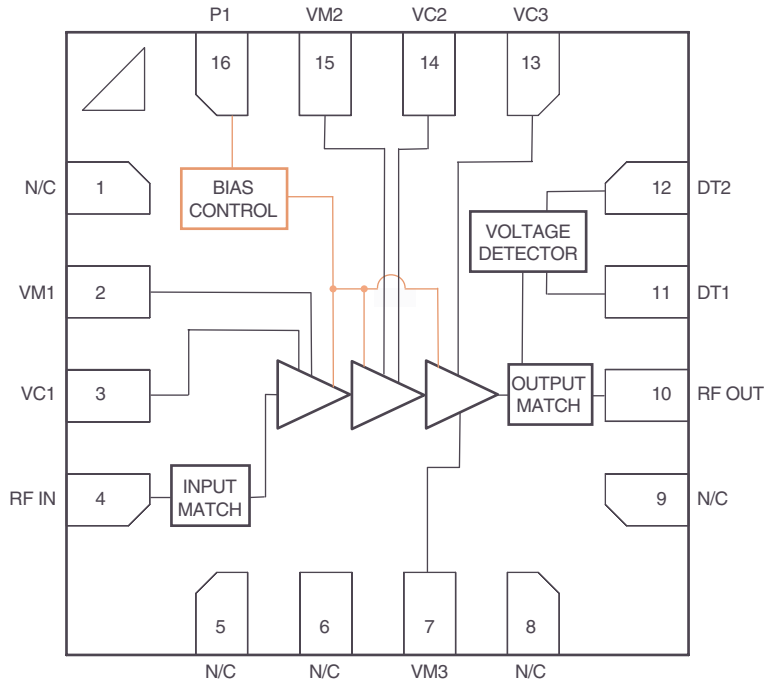

| Pin | Description |
|-----|-------------|
| 1   | N/C         |
| 2   | VM1         |
| 3   | VC1         |
| 4   | RF IN       |
| 5   | N/C         |
| 6   | N/C         |
| 7   | VM3         |
| 8   | N/C         |
| 9   | N/C         |
| 10  | RF OUT      |
| 11  | DT1 (Vdet)  |
| 12  | DT2         |
| 13  | VC3         |
| 14  | VC2         |
| 15  | VM2         |
| 16  | P1 (Logic)  |

## Application Information

The RMPA5251 can be optimized to work over 2 frequency ranges, 4.9 to 5.35 GHz (Low Band) and 5.15 to 5.85 GHz (High Band).

Using the 2 external component configurations described on the next page, the RMPA5251 can be optimized to give the best EVM, power and gain over a specified bandwidth.

The data on sheets 7–9 shows the performance when the evaluation board is configured for either low or high band performance.

## Evaluation Board Schematic

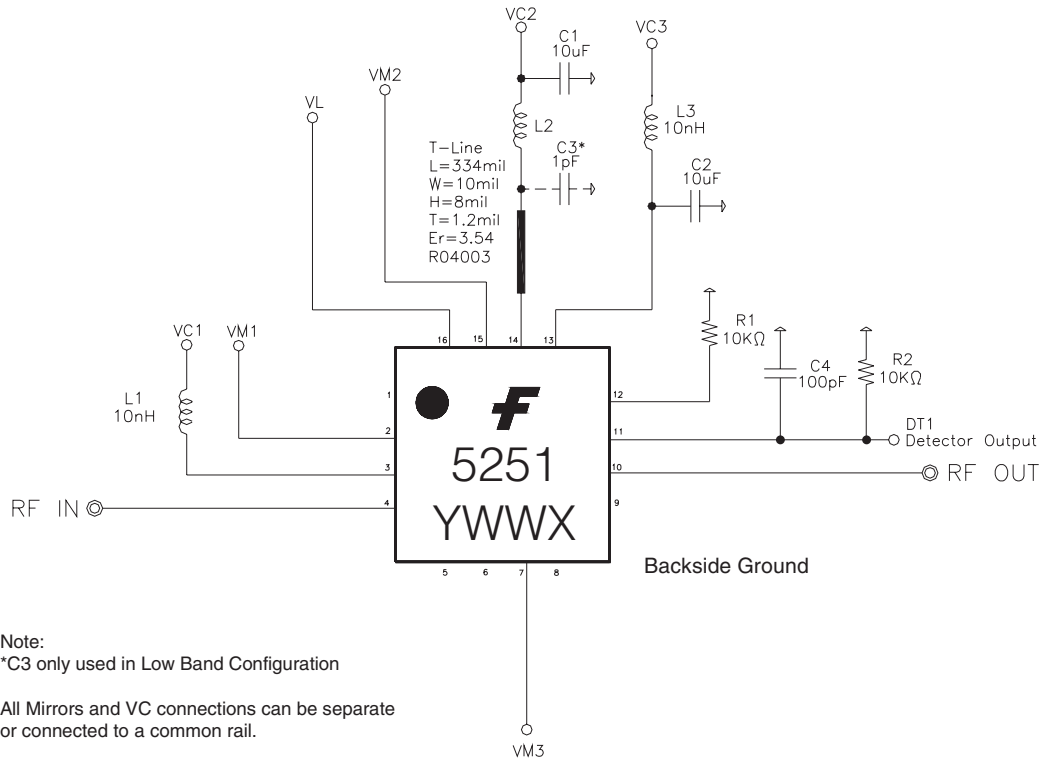

## Evaluation Board Bill of Materials

### RMPA5251 4.90 to 5.35 GHz Operation Eval Board BOM (Low Band)

| No. | Ref      | Value | Unit | Qty | Size | Description               | MFG                | Part No.           | Comments             |
|-----|----------|-------|------|-----|------|---------------------------|--------------------|--------------------|----------------------|
| 1   | C1,C2    | 10    | μF   | 2   | 0805 | 10μF Capacitor            | Murata             | GRM21BR60J106KE01D | Decoupling Capacitor |
| 2   | C3       | 1     | pF   | 1   | 0603 | 1pF Capacitor             | Murata             | GRM39C0G010B100V   |                      |
| 3   | C4       | 100   | pF   | 1   | 0402 | 100pF Capacitor           | Murata             | GRM1885C1H101JA01D | Detector Capacitor   |
| 4   | R1,R2    | 10K   | Ω    | 2   | 0402 | 10K Ω Resistor            | IMS                | RCI-0402-1002J     | Detector Resistor    |
| 5   | L1,L2,L3 | 10    | nH   | 3   | 0402 | 10nH Inductor             | Toko               | LLV1005FB10NJ      | RF Choke             |
| 6   | B1       |       |      | 1   |      | Fixture Board             | Crown Circuits     | G657432            |                      |
| 7   | J1,J2    |       |      | 2   |      | Jack End Launch SMA       | Johnson Components | 142-0701-841       |                      |
| 8   | J3       |       |      | 11  |      | Right Angle Single Header | Digikey            | S1322-12-ND        |                      |
| 9   | A1       |       |      | 1   |      | Packaged MMIC             | Fairchild          | RMPA5251           |                      |

### RMPA5251 5.15 to 5.85 GHz Operation Eval Board BOM (High Band)

| No. | Ref   | Value | Unit | Qty | Size | Description               | MFG                | Part No.           | Comments             |
|-----|-------|-------|------|-----|------|---------------------------|--------------------|--------------------|----------------------|
| 1   | C1,C2 | 10    | μF   | 2   | 0805 | 10 μF Capacitor           | Murata             | GRM21BR60J106K     | Decoupling Capacitor |
| 2   | C4    | 100   | pF   | 1   | 0402 | 100 pF Capacitor          | Murata             | GRM1885C1H101JA01D | Detector Capacitor   |
| 3   | R1,R2 | 10K   | Ω    | 2   | 0402 | 10 KΩ Resistor            | IMS                | RCI-0402-1002J     | Detector Resistor    |
| 4   | L1,L3 | 10    | nH   | 2   | 0402 | 10 nH Inductor            | Toko               | LLV1005FB10NJ      | RF Choke             |
| 5   | L2    | 15    | nH   | 1   | 0402 | 15 nH Inductor            | Toko               | LLV1005FB15NJ      | RF Choke             |
| 6   | B1    |       |      | 1   |      | Fixture Board             | Crown Circuits     | G657432            |                      |
| 7   | J1,J2 |       |      | 2   |      | Jack End Launch SMA       | Johnson Components | 142-0701-841       |                      |
| 8   | J3    |       |      | 11  |      | Right Angle Single Header | Digikey            | S1322-12-ND        |                      |
| 9   | A1    |       |      | 1   |      | Packaged MMIC             | Fairchild          | RMPA5251           |                      |

### Evaluation Board Layout

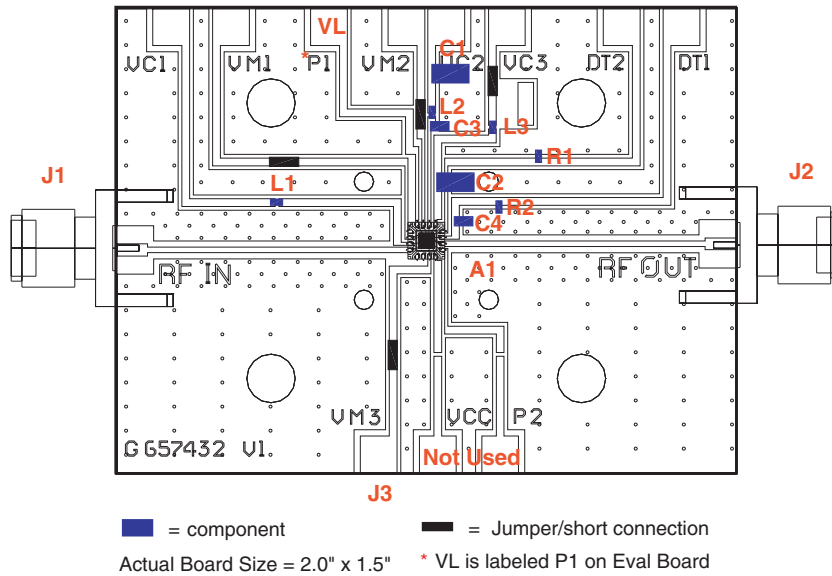

### Evaluation Board Operation

#### Recommended turn-on sequence:

- 1) Connect RF ports J1, J2 to RF test equipment.
- 2) Connect common ground terminal to the Ground (GND) pin on the board.
- 3) Connect logic control pin VL to positive supply.
- 4) Connect terminals VC1, VC2 and VC3 together and connect to positive supply (VC).
- 5) Connect terminals VM1, VM2 and VM3 together and connect to positive supply (VM).
- 6) Connect voltmeter to Detector Output, pin DT1.
- 7) Connect pin DT2 to ground.
- 8) Apply high voltage of +2.4V to logic control pin VL. (On)
- 9) Apply positive voltage of 3.3V to VC1, VC2 and VC3 (first, second and third stage collector).
- 10) Apply positive voltage of 3.3V to VM1, VM2 and VM3 (bias networks)<sup>2</sup>.
- 11) At this point, you should expect to observe the following positive currents flowing into the pins:

| Pin        | Current |
|------------|---------|
| VL         | ~150 μA |
| VC (Total) | ~184 mA |
| VM (Total) | ~16 mA  |

- 12) Apply input RF power to SMA connector pin RF IN. Currents on collector pins will vary depending on the input drive level.
- 13) Vary positive voltage VL from +2.4V to +0.5V to shut down the amplifier or alter the power level.

Shut down current flow into the pins:

| Pin        | Current |
|------------|---------|
| VL         | <1 nA   |
| VC (total) | <1 nA   |
| VM (total) | <1.9 mA |

**Recommended turn-off sequence:**

Use reverse order described in the turn-on sequence above.

**Note:**

1. Turn on sequence is not critical and it is not necessary to sequence power supplies in actual system level design.
2. VM may be adjusted from +2.9 to +3.3V to adjust bias current operation. See Typical Characteristics.

**Package Outline**

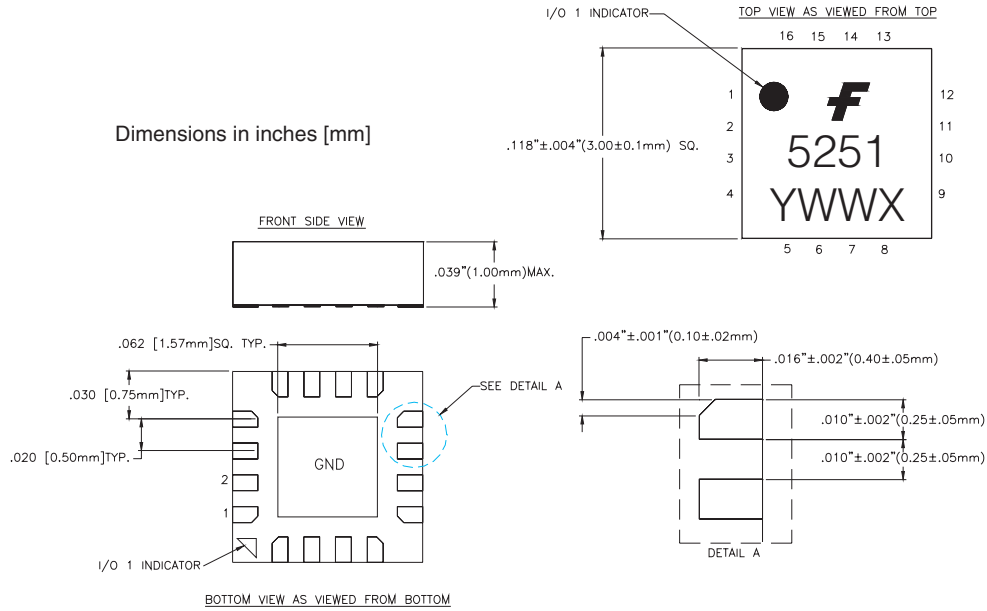

**Application Information**

**Precautions to Avoid Permanent Device Damage:**

—Static Sensitivity: Follow ESD precautions to protect against ESD damage:

- A properly grounded static-dissipative surface on which to place devices.
- Static-dissipative floor or mat.
- A properly grounded conductive wrist strap for each person to wear while handling devices.

# Typical Characteristics (802.11a)

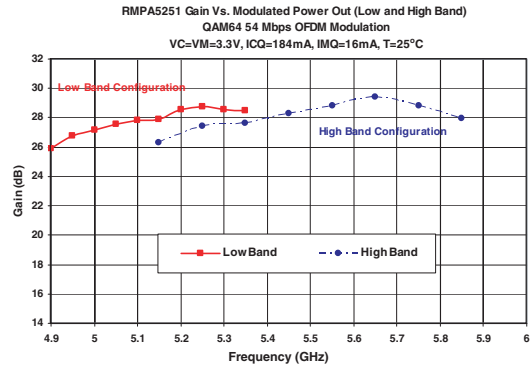
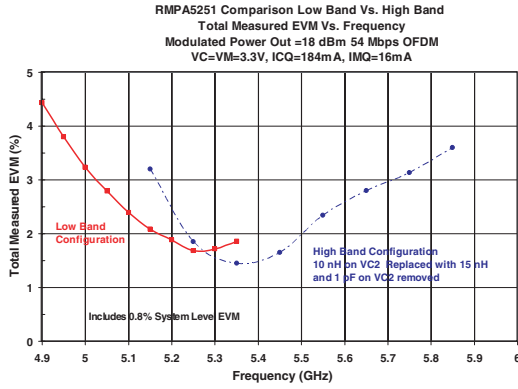

## Low Band Configuration

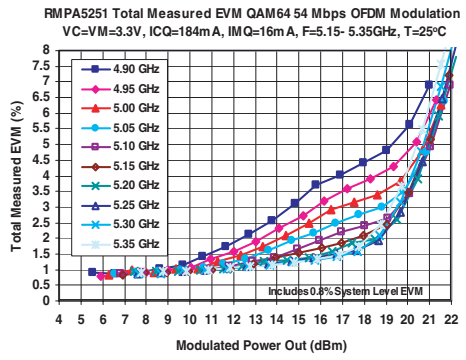

## High Band Configuration

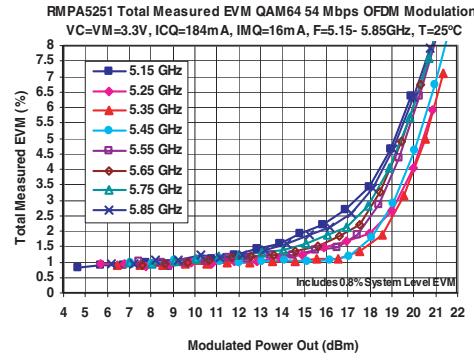

## Low Band Configuration

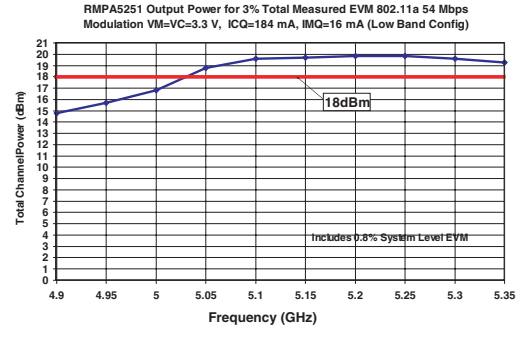

## High Band Configuration

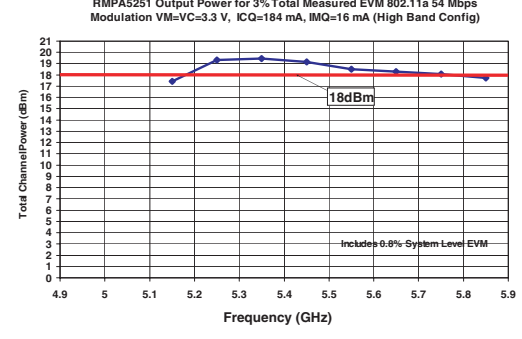

## Low Band Configuration

**RMPA5251 Spectral Plot Showing Compliance to 802.11a Spectral Mask Requirements @ 21.0 dBm Modulated Output Power 54Mbps OFDM Data, 16.7 MHz BW, 176µS Burst, 100µS Idle, Frequency = 5.25 GHz, VC = VM = 3.3V, ICQ = 184 mA, IMQ = 16 mA, T = 25°C**

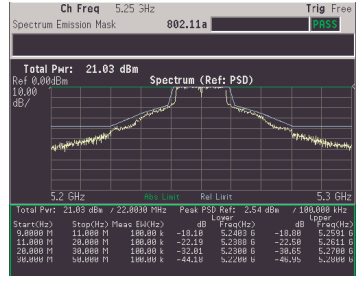

## High Band Configuration

**RMPA5251 Spectral Plot Showing Compliance to 802.11a Spectral Mask Requirements @ 20.0 dBm Modulated Output Power 54Mbps OFDM Data, 16.7 MHz BW, 176µS Burst, 100µS Idle, Frequency = 5.5 GHz, VC = VM = 3.3V, ICQ = 184 mA, IMQ = 16 mA, T = 25°C**

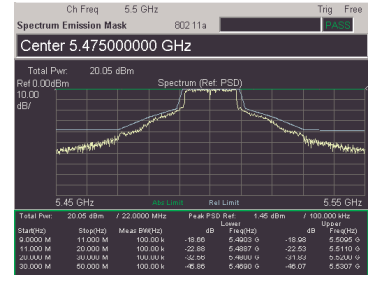

# Typical Characteristics (802.11a) (continued)

## Low Band Configuration

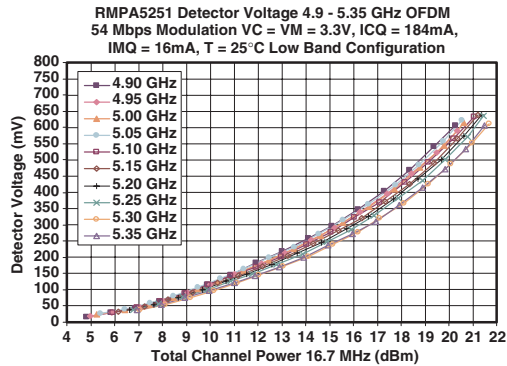

## High Band Configuration

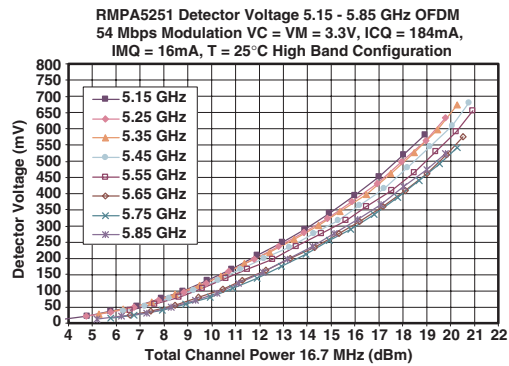

## Low Band Configuration

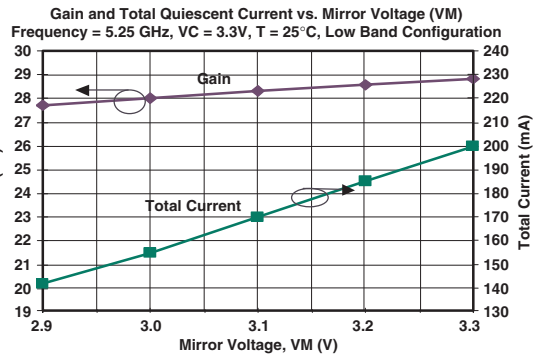
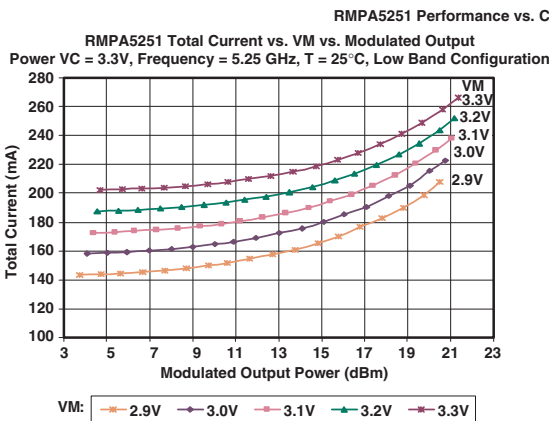

\*Total current can be varied by resetting the quiescent current by means of adjusting the mirror voltage, VM.

## Low Band Configuration

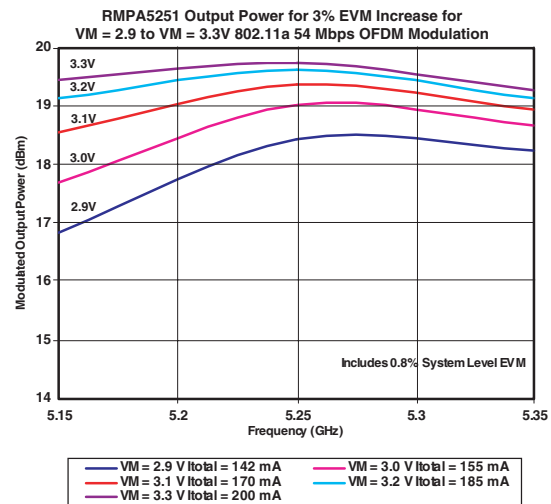
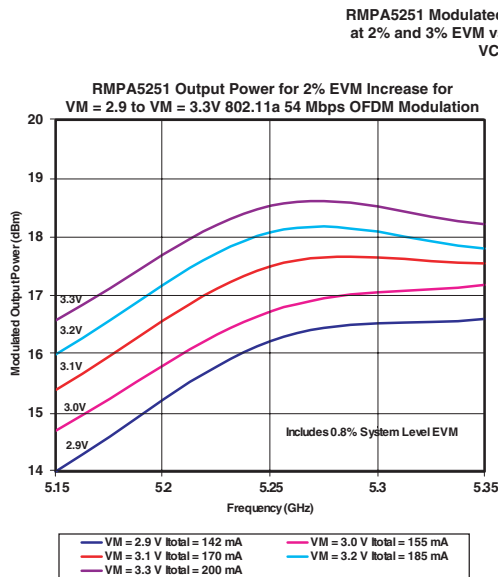



# Typical Characteristics (Single Tone) (continued)

## Low Band Configuration

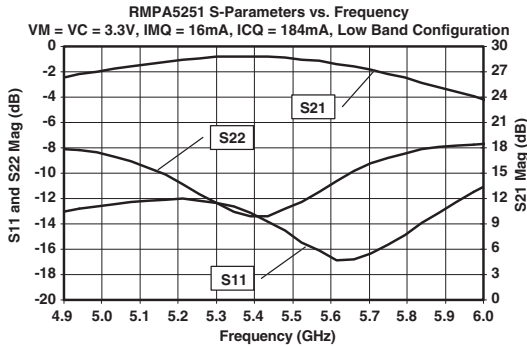

## High Band Configuration

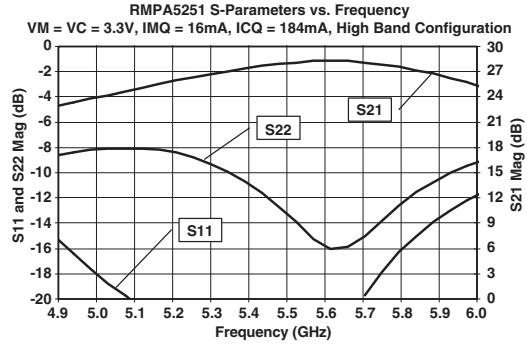

## Low Band Configuration

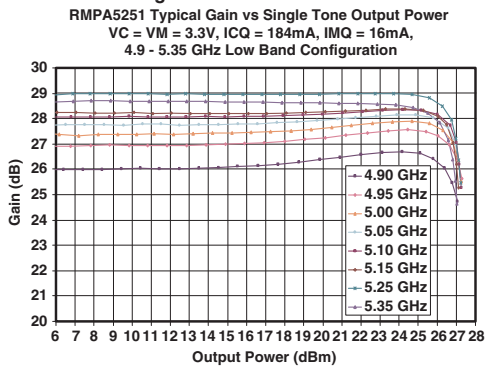

## High Band Configuration

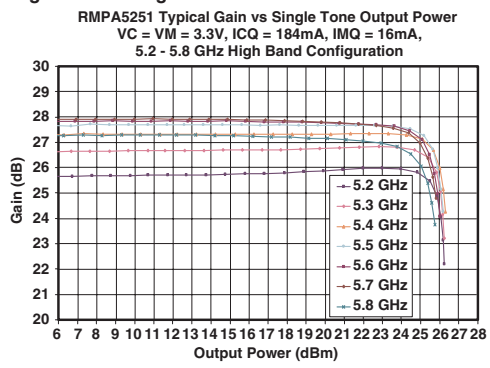

## Low Band Configuration

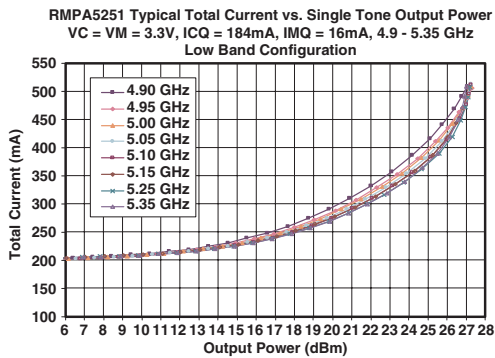

## High Band Configuration

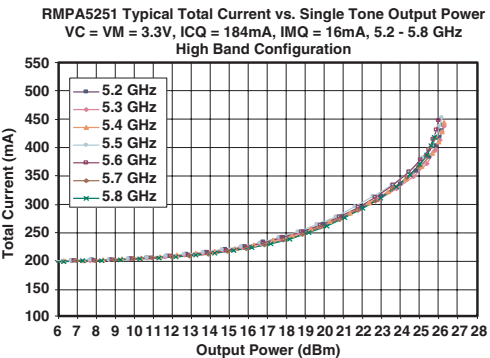

## High Band Configuration

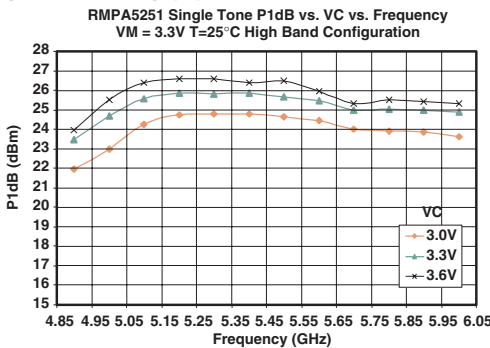
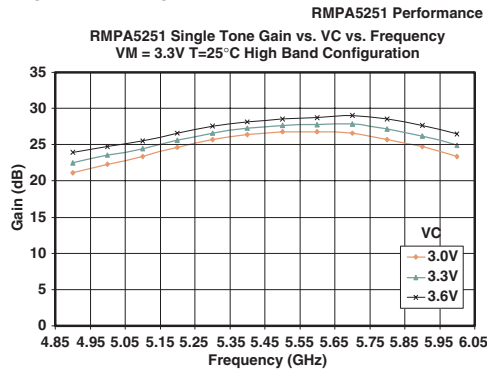

## TRADEMARKS

The following are registered and unregistered trademarks Fairchild Semiconductor owns or is authorized to use and is not intended to be an exhaustive list of all such trademarks.

|                                      |                     |               |                     |                 |
|--------------------------------------|---------------------|---------------|---------------------|-----------------|
| ACEx™                                | FAST®               | ISOPLANAR™    | Power247™           | Stealth™        |
| ActiveArray™                         | FASTr™              | LittleFET™    | PowerEdge™          | SuperFET™       |
| Bottomless™                          | FPST™               | MICROCOUPLER™ | PowerSaver™         | SuperSOT™-3     |
| CoolFET™                             | FRFET™              | MicroFET™     | PowerTrench®        | SuperSOT™-6     |
| CROSSVOLT™                           | GlobalOptoisolator™ | MicroPak™     | QFET®               | SuperSOT™-8     |
| DOMET™                               | GTO™                | MICROWIRE™    | QS™                 | SyncFET™        |
| EcoSPARK™                            | HiSeC™              | MSX™          | QT Optoelectronics™ | TinyLogic®      |
| E <sup>2</sup> CMOS™                 | μC™                 | MSXPro™       | Quiet Series™       | TINYOPTO™       |
| EnSigna™                             | i-Lo™               | OCX™          | RapidConfigure™     | TruTranslation™ |
| FACT™                                | ImpliedDisconnect™  | OCXPro™       | RapidConnect™       | UHC™            |
| FACT Quiet Series™                   |                     | OPTOLOGIC®    | μSerDes™            | UltraFET®       |
| Across the board. Around the world.™ |                     | OPTOPLANAR™   | SILENT SWITCHER®    | VCX™            |
| The Power Franchise®                 |                     | PACMAN™       | SMART START™        |                 |
| Programmable Active Droop™           |                     | POP™          | SPM™                |                 |

## DISCLAIMER

FAIRCHILD SEMICONDUCTOR RESERVES THE RIGHT TO MAKE CHANGES WITHOUT FURTHER NOTICE TO ANY PRODUCTS HEREIN TO IMPROVE RELIABILITY, FUNCTION OR DESIGN. FAIRCHILD DOES NOT ASSUME ANY LIABILITY ARISING OUT OF THE APPLICATION OR USE OF ANY PRODUCT OR CIRCUIT DESCRIBED HEREIN; NEITHER DOES IT CONVEY ANY LICENSE UNDER ITS PATENT RIGHTS, NOR THE RIGHTS OF OTHERS.

## LIFE SUPPORT POLICY

FAIRCHILD'S PRODUCTS ARE NOT AUTHORIZED FOR USE AS CRITICAL COMPONENTS IN LIFE SUPPORT DEVICES OR SYSTEMS WITHOUT THE EXPRESS WRITTEN APPROVAL OF FAIRCHILD SEMICONDUCTOR CORPORATION. As used herein:

1. Life support devices or systems are devices or systems which, (a) are intended for surgical implant into the body, or (b) support or sustain life, or (c) whose failure to perform when properly used in accordance with instructions for use provided in the labeling, can be reasonably expected to result in significant injury to the user.
2. A critical component is any component of a life support device or system whose failure to perform can be reasonably expected to cause the failure of the life support device or system, or to affect its safety or effectiveness.

## PRODUCT STATUS DEFINITIONS

### Definition of Terms

| Datasheet Identification | Product Status         | Definition  |
|--------------------------|------------------------|---|
| Advance Information      | Formative or In Design | This datasheet contains the design specifications for product development. Specifications may change in any manner without notice.  |
| Preliminary              | First Production       | This datasheet contains preliminary data, and supplementary data will be published at a later date. Fairchild Semiconductor reserves the right to make changes at any time without notice in order to improve design. |
| No Identification Needed | Full Production        | This datasheet contains final specifications. Fairchild Semiconductor reserves the right to make changes at any time without notice in order to improve design.   |
| Obsolete                 | Not In Production      | This datasheet contains specifications on a product that has been discontinued by Fairchild semiconductor. The datasheet is printed for reference information only.   |