

FAN5099 Wide Frequency Synchronous Buck PWM & LDO Controller

Features

- General Purpose PWM Regulator and LDO Controller
- Input Voltage Range: 3V to 24V
- Output Voltage Range: 0.8V to 15V
- V_{CC}
 - 5V
 - Shunt Regulator for 12V Operation
- Support for Ceramic Cap on PWM Output
- Programmable Current Limit for PWM Output
- Wide Programmable Switching Frequency Range (50kHz to 600kHz)
- $R_{DS(ON)}$ Current Sensing
- Internal Synchronous Boot Diode
- Soft-Start for both PWM and LDO
- Multi-Fault Protection with Optional Auto-restart
- 16-Pin TSSOP Package

Applications

- High-Efficiency (80+) Computer Power Supplies
- PC/Server Motherboard Peripherals
 - V_{CC_MCH} (1.5V), V_{DDQ} (1.5V) and V_{TT_GTL} (1.25V)
- Power Supply for
 - FPGA, DSP, Embedded Controllers, Graphic Card Processor, and Communication Processors
- High-Power DC-to-DC Converters

Related Application Notes

- *AN-6020 FAN5099 Component Calculation and Simulation Tools*
- *AN-6005 Synchronous Buck MOSFET Loss Calculations with Excel Model*

Description

The FAN5099 combines a high-efficiency pulse-width modulated (PWM) controller and an LDO (Low DropOut) linear regulator controller. The PWM controller is designed to operate over a wide frequency range (50kHz to 600kHz) to accommodate a variety of applications. Synchronous rectification provides high efficiency over a wide range of load currents. Efficiency is further enhanced by using the low-side MOSFET's $R_{DS(ON)}$ to sense current. In addition, the capability to operate at low switching frequencies provides opportunities to boost power supply efficiency by reducing switching losses and gain cost savings using low-cost materials, such as powdered iron cores, on the output inductor.

Both the linear and PWM regulator soft-start are controlled by a single external capacitor, to limit inrush current from the supply when the regulators are first enabled. Current limit for PWM is also programmable.

The FAN5099's ability to handle wide input voltage ranges makes this controller suitable for power solutions in a wide range of applications involving conversion input voltages from Silver box, battery, and adapters. The PWM regulator employs a summing-current-mode control with external compensation to achieve fast load transient response and provide system design optimization.

FAN5099 is offered in both industrial temperature grade (-40°C to +85°C) as well as commercial temperature grade (-10°C to +85°C).

Ordering Information

Part Number	Operating Temp. Range	Pb-Free	Package	Packing Method	Qty/Reel
FAN5099MTCX	-10°C to +85°C	Yes	16-Lead TSSOP	Tape and Reel	2500
FAN5099EMTCX	-40°C to +85°C	Yes	16-Lead TSSOP	Tape and Reel	2500
FAN5099MX	-10°C to +85°C	Yes	16-Lead SOIC	Tape and Reel	2500
FAN5099EMX	-40°C to +85°C	Yes	16-Lead SOIC	Tape and Reel	2500

Note: Contact Fairchild sales for availability of other package options.

Pin Assignment

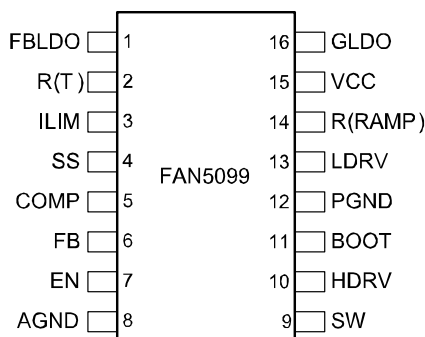

Figure 2. Pin Assignment

Pin Description

Pin No.	Pin Name	Pin Description
1	FBLDO	LDO Feedback. This node is regulated to V_{REF} .
2	R(T)	Oscillator Set Resistor. This pin provides oscillator switching frequency adjustment. By placing a resistor (RT) from this pin to GND, the nominal 50kHz switching frequency is increased.
3	ILIM	Current Limit. A resistor from this pin to GND sets the current limit.
4	SS	Soft-Start. A capacitor from this pin to GND programs the slew rate of the converter and the LDO during initialization. It also sets the time by which the converter delays when restarting after a fault occurs. SS has to reach 1.2V before fault shutdown feature is enabled. The LDO is enabled when SS reaches 2.2V.
5	COMP	COMP. The output of the error amplifier drives this pin.
6	FB	Feedback. This pin is the inverting input of the internal error amplifier. Use this pin, in combination with the COMP pin, to compensate the feedback loop of the converter.
7	EN	Enable. Enables operation when pulled to logic high. Toggling EN resets the regulator after a latched fault condition. This is a CMOS input whose state is indeterminate if left open and needs to be properly biased at all times.
8	AGND	Analog Ground. The signal ground for the IC. All internal control voltages are referred to this pin. Tie this pin to the ground island/plane through the lowest impedance connection available.
9	SW	Switching Node. Return for the high-side MOSFET driver and a current sense input. Connect to source of high-side MOSFET and drain of low-side MOSFET.
10	HDRV	High-Side Gate Drive Output. Connect to the gate of the high-side power MOSFETs. This pin is also monitored by the adaptive shoot-through protection circuitry to determine when the high-side MOSFET is turned off.
11	BOOT	Bootstrap Supply Input. Provides a boosted voltage to the high-side MOSFET driver. Connect to bootstrap capacitor as shown in Figure 1.
12	PGND	Power Ground. The return for the low-side MOSFET driver. Connect to source of low-side MOSFET.
13	LDRV	Low-Side Gate Drive Output. Connect to the gate of the low-side power MOSFETs. This pin is also monitored by the adaptive shoot-through protection circuitry to determine when the lower MOSFET is turned off.
14	R(RAMP)	Ramp Resistor. A resistor from this pin to VIN sets the ramp amplitude and provides voltage feed-forward.
15	VCC	V_{CC}. Provides bias power to the IC and the drive voltage for LDRV. Bypass with a ceramic capacitor as close to this pin as possible. This pin has a shunt regulator which draws current when the input voltage is above 5.6V.
16	GLDO	Gate Drive for the LDO. Turned off (low) until SS is greater than 2.2V.

Absolute Maximum Ratings

The “Absolute Maximum Ratings” are those values beyond which the safety of the device cannot be guaranteed. The device should not be operated at these limits. The parametric values defined in the Electrical Characteristics tables are not guaranteed at the absolute maximum ratings. The “Recommended Operating Conditions” table defines the conditions for actual device operation.⁽¹⁾

Parameter	Min.	Max.	Unit	
V _{CC} to PGND		6.0	V	
BOOT to PGND		33.0	V	
SW to PGND	Continuous	-0.5	33.0	V
	Transient (t < 50ns, f < 500kHz)	-3.0	33.0	V
HDRV (V _{BOOT} – V _{SW})		6.0	V	
LDRV	-0.5	6.0	V	
All Other Pins	-0.3	V _{CC} + 0.3	V	
Maximum Shunt Current for V _{CC}		150	mA	
Electrostatic Discharge (ESD) Protection Level ⁽²⁾	HBM	3.5	kV	
	CDM	1.8		

Notes:

- Stresses above those listed under “Absolute Maximum Ratings” may cause permanent damage to the device. This is a stress rating only; functional operation of the device at these or any conditions above those indicated in the operational section of this specification is not implied. Exposure to absolute maximum rating conditions for extended periods may affect device reliability. Absolute maximum ratings apply individually only, not in combination. Unless otherwise specified, all other voltages are referenced to AGND.
- Using Mil Std. 883E, method 3015.7 (Human Body Model) and EIA/JESD22C101-A (Charge Device Model).

Thermal Information

Symbols	Parameter	Min.	Typ.	Max.	Unit
T _{STG}	Storage Temperature	-65		150	°C
T _L	Lead Soldering Temperature, 10 Seconds			300	°C
	Vapor Phase, 60 Seconds			215	°C
	Infrared, 15 Seconds			220	°C
P _D	Power Dissipation, T _A = 25°C			715	mW
θ _{JC}	Thermal Resistance – Junction-to-Case		37		°C/W
θ _{JA}	Thermal Resistance – Junction-to-Ambient ⁽³⁾		100		°C/W

- Junction-to-ambient thermal resistance, θ_{JA}, is a strong function of PCB material, board thickness, thickness and number of copper planes, number of vias used, diameter of vias used, available copper surface, and attached heat sink characteristics.

Recommended Operating Conditions

Symbols	Parameter	Conditions	Min.	Typ.	Max.	Unit
V _{CC}	Supply Voltage	V _{CC} to GND	4.5	5.0	5.5	V
T _A	Ambient Temperature	Commercial	-10		85	°C
		Industrial	-40		85	°C
T _J	Junction Temperature				125	°C

Electrical Characteristics

Unless otherwise noted, $V_{CC} = 5V$, $T_A = 25^\circ C$, using the circuit in Figure 1. The '•' denotes that the specifications apply to the full ambient operating temperature range.^(4,5)

Symbol	Parameter	Conditions		Min.	Typ.	Max.	Unit
Supply Current							
I_{VCC}	V_{CC} Current (Quiescent)	HDRV, LDRV Open	•	2.6	3.2	3.8	mA
$I_{VCC(SD)}$	V_{CC} Current (Shutdown)	EN = 0V, $V_{CC} = 5.5V$	•		200	400	μA
$I_{VCC(OP)}$	V_{CC} Current (Operating)	EN = 5V, $V_{CC} = 5.0V$, $Q_{FET} = 20nC$, $F_{SW} = 200kHz$			10	15	mA
V_{SHUNT}	V_{CC} Voltage ⁽⁶⁾	Sinking 1mA to 100mA at V_{CC} Pin		5.4		5.9	V
Under-Voltage Lockout (UVLO)							
UVLO(H)	Rising V_{CC} UVLO Threshold		•	4.00	4.25	4.50	V
UVLO(L)	Falling V_{CC} UVLO Threshold		•	3.60	3.75	4.00	V
	V_{CC} UVLO Threshold Hysteresis				0.5		V
Soft-Start							
I_{SS}	Current				10		μA
$V_{LDOSTART}$	LDO Start Threshold				2.2		V
V_{SSOK}	PWM Protection Enable Threshold				1.2		V
Oscillator							
F_{OSC}	Frequency	$R(T) = 25.5K\Omega \pm 1\%$		240	300	360	kHz
		$R(T) = 199K\Omega \pm 1\%$		60	80	100	kHz
		$R(T) = \text{Open}$			50		kHz
	Operating Frequency Range			40		600	kHz
ΔV_{RAMP}	Ramp Amplitude (Peak-to-Peak)	$R(RAMP) = 330K\Omega$			0.4		V
	Minimum On Time	$f = 200kHz$			200		ns
Reference							
V_{REF}	Reference Voltage (Measured at FB Pin)	$T_A = 0^\circ C \text{ to } 70^\circ C$	•	790	800	810	mV
		$T_A = -40^\circ C \text{ to } 85^\circ C$	•	788	800	812	mV
	Current Amplifier Reference (at SW node)				160		mV
Error Amplifier							
	DC Gain				80		dB
GBWP	Gain-BW Product				25		MHz
S/R	Slew Rate	10pF across COMP to GND			8		V/ μS
	Output Voltage Swing	No Load	•	0.5		4.0	V
I_{FB}	FB Pin Source Current						μA
Gate Drive							
R_{HUP}	HDRV Pull-up Resistor	Sourcing	•		1.8	3.0	Ω
R_{HDN}	HDRV Pull-down Resistor	Sinking	•		1.8	3.0	Ω
R_{LUP}	LDRV Pull-up Resistor	Sourcing	•		1.8	3.0	Ω
R_{LDN}	LDRV Pull-down Resistor	Sinking	•		1.2	2.0	Ω

Electrical Characteristics (Continued)

Unless otherwise noted, $V_{CC} = 5V$, $T_A = 25^\circ C$, using the circuit in Figure 1. The '•' denotes that the specifications apply to the full ambient operating temperature range.^(4, 5)

Symbol	Parameter	Conditions		Min.	Typ.	Max.	Unit
Protection/Disable							
I_{LIM}	ILIMIT Source Current			9	10	11	μA
I_{SWPD}	SW Pull-down Current	SW = 1V, EN = 0V					mA
V_{UV}	Under-Voltage Threshold	As % of set point; 2 μ S noise filter	•	65	75	80	%
V_{OV}	Over-Voltage Threshold	As % of set point; 2 μ S noise filter	•	110	115	120	%
Supply Current							
TSD	Thermal Shutdown				160		$^\circ C$
V_{EN}	Enable Threshold Voltage	Enable Condition	•	2.0			V
		Disable Condition	•			0.8	V
	Enable Source Current	$V_{CC} = 5V$			50		μA
	Enable Sink Current	$V_{CC} = 5V$ and fault conditions (overload, short-circuit, over-voltage, under-voltage)			10		μA
Low Drop-Out (LDO)⁽⁷⁾							
V_{LDOREF}	Reference Voltage (measured at FBLDO pin)	$T_A = 0^\circ C$ to $70^\circ C$	•	775	800	825	mV
		$T_A = -40^\circ C$ to $85^\circ C$	•	770	800	830	mV
	Regulation	$0A \leq I_{LOAD} \leq 5A$	•	1.17	1.20	1.23	V
V_{LDO_DO}	Drop-out Voltage	$I_{LOAD} \leq 5A$ and $R_{DS-ON} < 50m\Omega$				0.3	V
	External Gate Drive	$V_{CC} = 4.75V$	•			4.5	V
		$V_{CC} = 5.6V$	•			5.3	V
	Gate Drive Source Current				1.2		mA
	Gate Drive Sink Current				400		μA

Notes:

- All limits at operating temperature extremes are guaranteed by design, characterization, and statistical quality control.
- AC specifications guaranteed by design/characterization (not production tested).
- For a case when V_{CC} is higher than the typical 5V V_{CC} , voltage observed at V_{CC} pin when the internal shunt regulator is sinking current to keep voltage on V_{CC} pin constant.
- Test Conditions: $V_{LDO_IN} = 1.5V$ and $V_{LDO_OUT} = 1.2V$.

Typical Performance Characteristics

$V_{IN}=12V$, $V_{dd}=5V$, $V_{OUT}=1.5V$, $V_{LDO}=1.2V$, $I_{load}=5A$, $I_{LDO}=2A$, $F_{osc} = 300kHz$, unless otherwise noted.

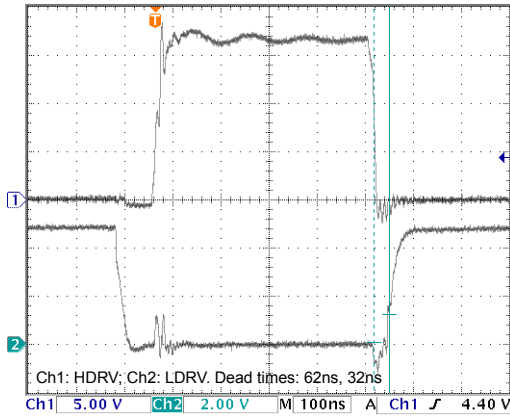

Figure 3. Dead Time Waveform

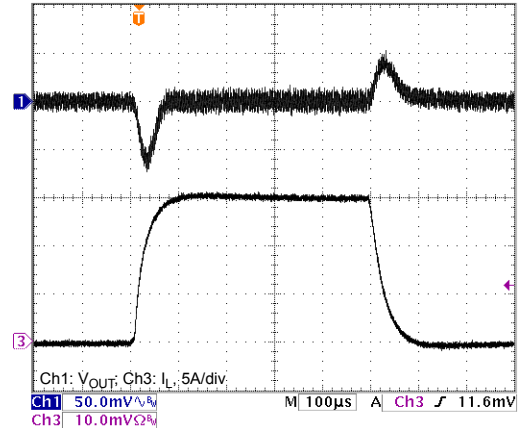

Figure 6. PWM Load Transient (0 to 15A)

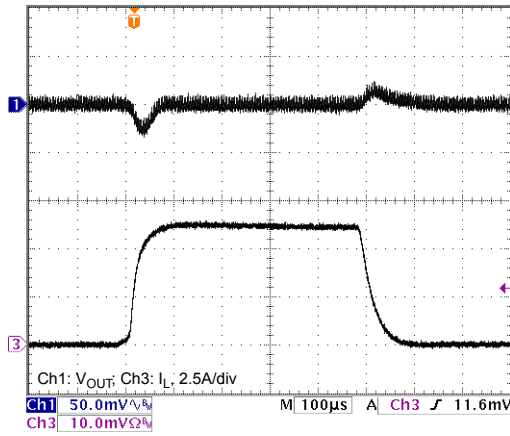

Figure 4. PWM Load Transient (0 to 5A)

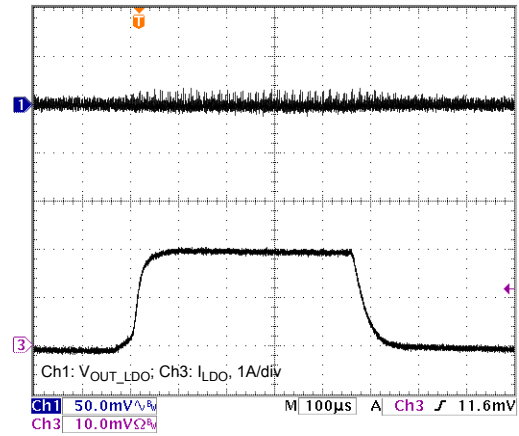

Figure 7. LDO Load Transient (0 to 2A)

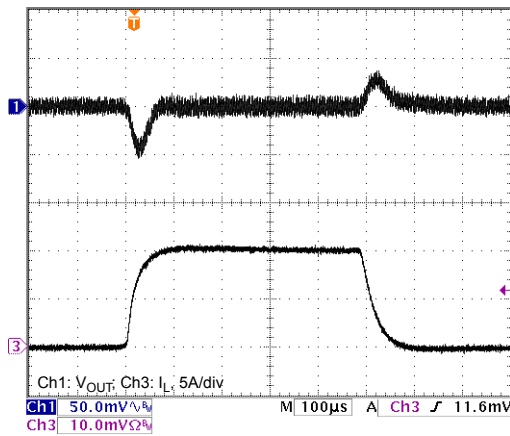

Figure 5. PWM Load Transient (0 to 10A)

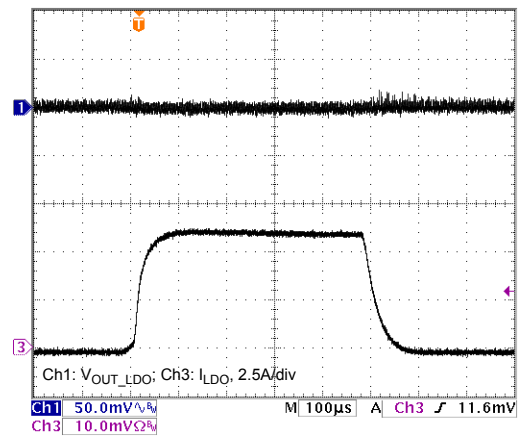

Figure 8. LDO Load Transient (0 to 5A)

Typical Performance Characteristics (Continued)

$V_{IN}=12V$, $V_{dd}=5V$, $V_{OUT}=1.5V$, $V_{LDO}=1.2V$, $I_{load}=5A$, $I_{LDO}=2A$, $F_{osc} = 300kHz$, unless otherwise noted.

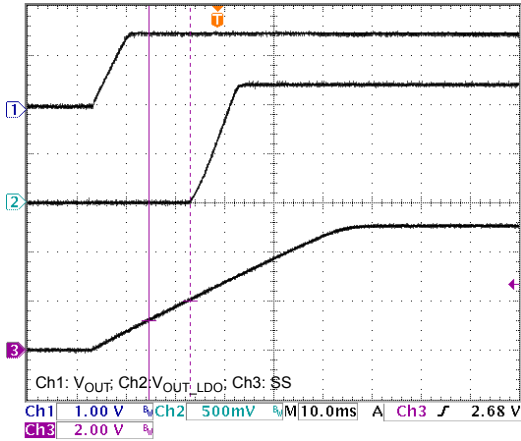

Figure 9. PWM/LDO Power Up

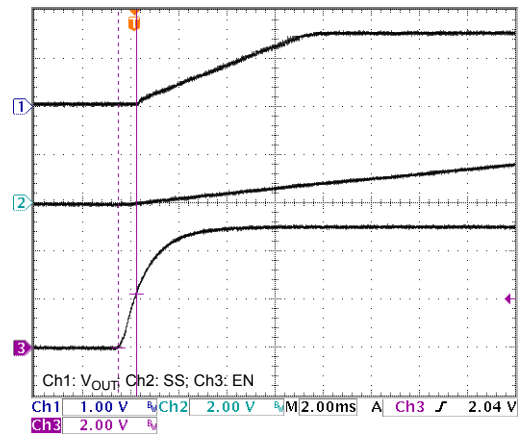

Figure 12. Enable On ($I_{PWM} = 5A$)

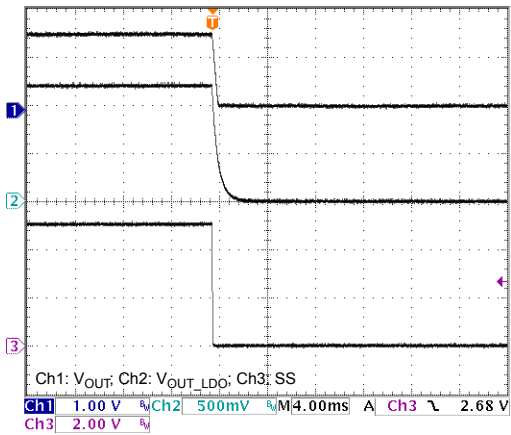

Figure 10. PWM/LDO Power Down

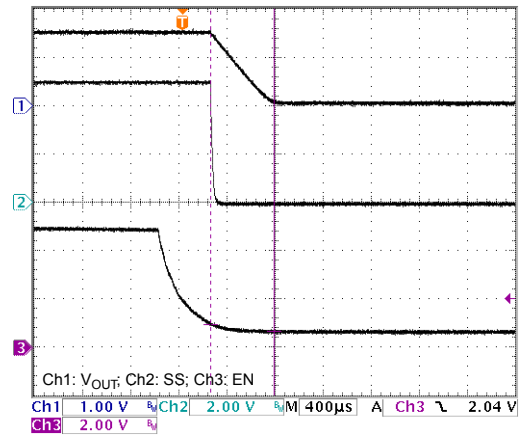

Figure 13. Enable Off ($I_{PWM} = 5A$)

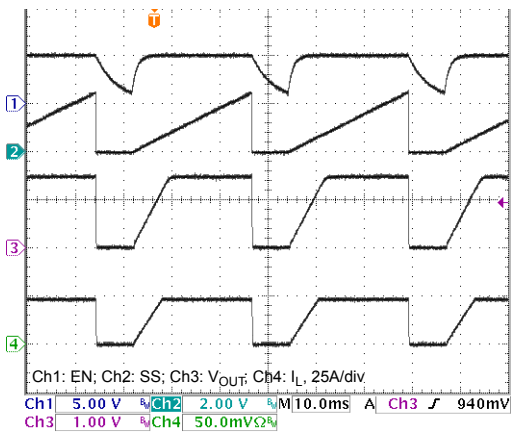

Figure 11. Auto Restart

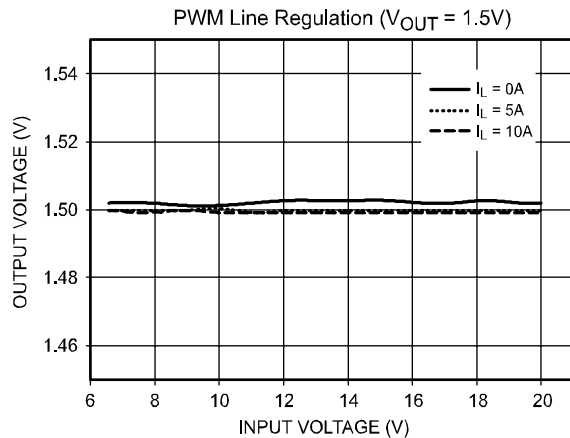

Figure 14. PWM Line Regulation

Typical Performance Characteristics (Continued)

$V_{IN}=12V$, $V_{dd}=5V$, $V_{OUT}=1.5V$, $V_{ldo}=1.2V$, $I_{load}=5A$, $I_{ldo}=2A$, $F_{osc} = 300kHz$, unless otherwise noted.

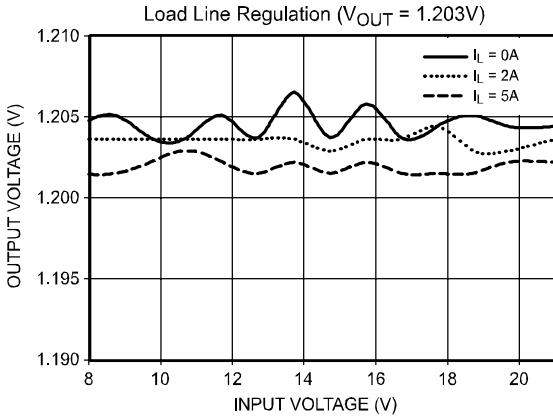

Figure 15. LDO Load Regulation

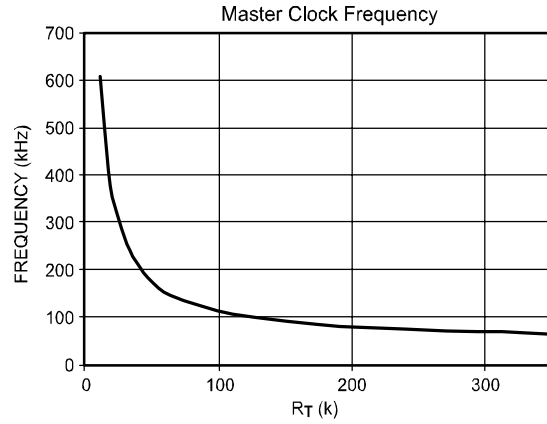

Figure 18. R_T vs. Frequency

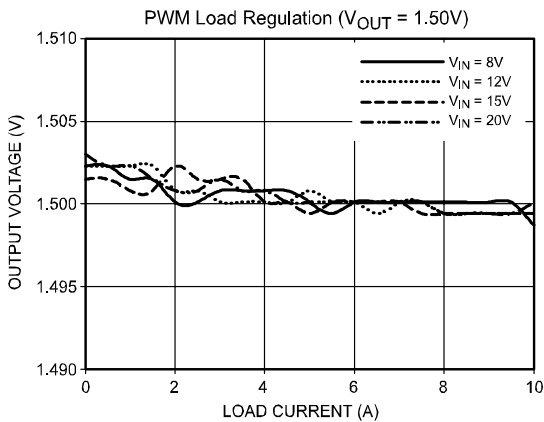

Figure 16. PWM Load Regulation

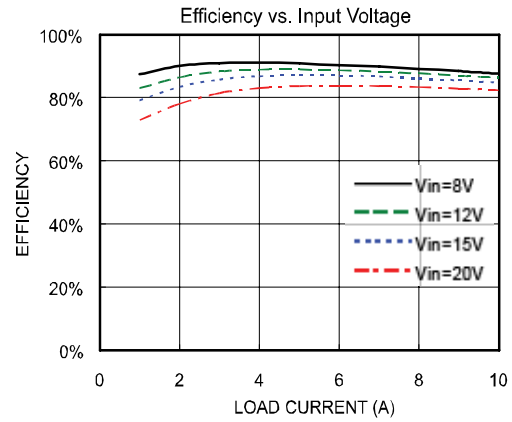

Figure 19. 1.5V PWM Efficiency

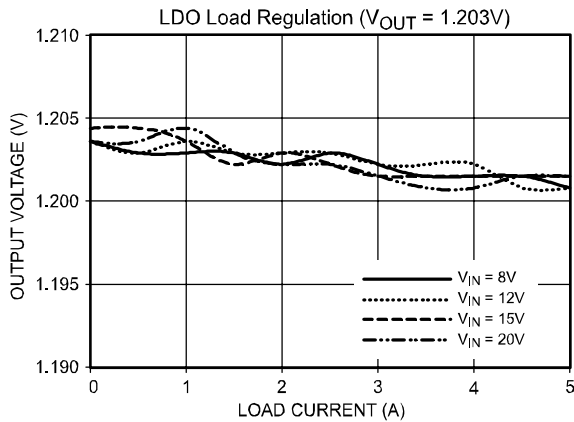

Figure 17. LDO Load Regulation

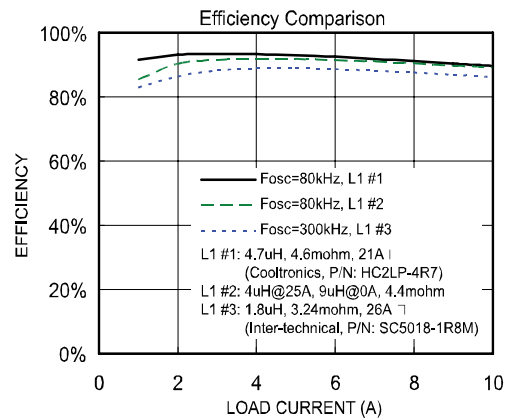

Figure 20. Efficiency Comparison at $V_{IN}=12V$

Block Diagram

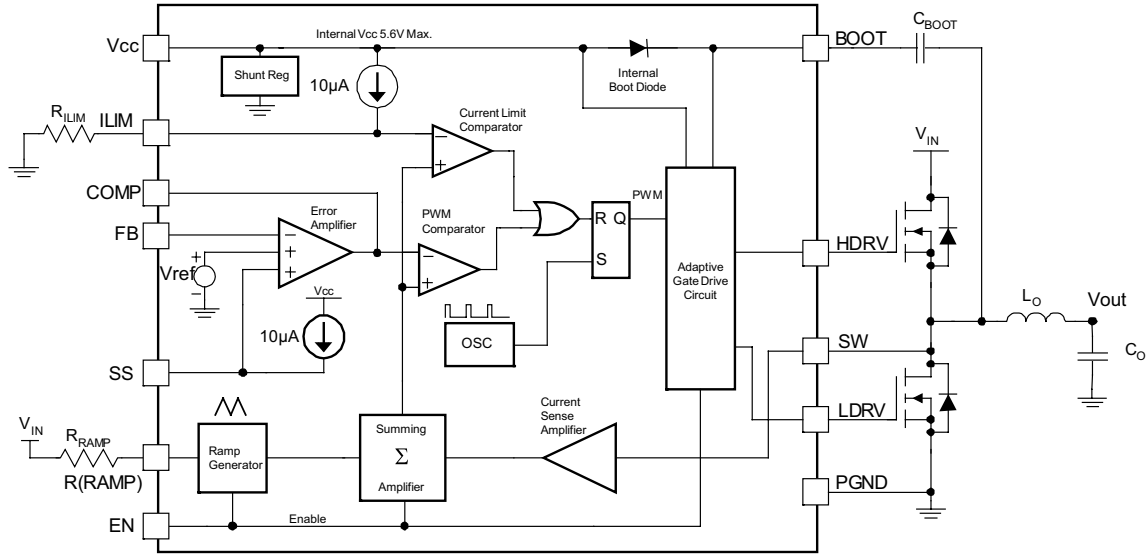

Figure 21. Block Diagram

Detailed Operation Description

FAN5099 combines a high-efficiency, fixed-frequency PWM controller designed for single-phase synchronous buck Point-Of-Load converters with an integrated LDO controller to support GTL-type loads. This controller is ideally suited to deliver low-voltage, high-current power supplies needed in desktop computers, notebooks, workstations, and servers. The controller comes with an integrated boot diode which helps reduce component cost and increase space savings. With this controller, the input to the power supply can be varied from 3V to 24V and the output voltage can be set to regulate at 0.8V to 15V on the switcher output. The LDO output can be configured to regulate between 0.8V to 3V and the input to the LDO can be from 1.5V to 5V, respectively. An internal shunt regulator at the V_{CC} pin facilitates the controller operation from either a 5V or 12V power source.

V_{CC} Bias Supply

FAN5099 can be configured to operate from 5V or 12V for V_{CC} . When 5V supply is used for V_{CC} , no resistor is required to be connected between the supply and the V_{CC} . When the 12V supply is used, a resistor R_{VCC} is connected between the 12V supply and the V_{CC} , as shown in Figure 1. The internal shunt regulator at the V_{CC} pin is capable of sinking 150mA of current to ensure the controller's internal V_{CC} is maintained at 5.6V maximum.

Choose a resistor such that:

- It is rated to handle the power dissipation.
- Current sunk within the controller is minimized to prevent IC temperature rise.

R_{VCC} Selection (IC)

The selection of R_{VCC} is dependent on:

- Variation of the 12V supply
- Sum of gate charges of top and bottom FETs (Q_{FET})
- Switching frequency (F_{SW})
- Shunt regulator minimum current (1mA)
- Quiescent Current of the IC (I_Q)

Calculate R_{VCC} based on the minimum input voltage for the V_{CC} :

$$R_{VCC} = \frac{V_{IN_{MIN}} - 5.6}{(I_Q + 1 \cdot 10^{-3} + Q_{FET} \cdot F_{SW} \cdot 1.2)}$$

For a typical example, where:

$V_{IN_{MIN}} = 11.5V$, $I_Q = 3mA$, $Q_{FET} = 30nC$, $F_{SW} = 300kHz$, R_{VCC} is calculated to be 398.65Ω .

PWM Section

The FAN5099's PWM controller combines the conventional voltage mode control and current sensing through lower MOSFET $R_{DS_{ON}}$ to generate the PWM signals. This method of current sensing is loss-less and cost effective. For more accurate current sense requirements, an optional external resistor can be connected with the bottom MOSFET in series.

PWM Operation

Refer to Figure 21 for the PWM control mechanism. The FAN5099 uses the summing mode method of control to generate the PWM pulses. The amplified output of the current-sense amplifier is summed with an internally generated ramp and the combined signal is amplified and compared with the output of the error amplifier to get the pulse width to drive the high-side MOSFET. The sensed current from the previous cycle is used to modulate the output of the summing block. The output of the summing block is also compared against the voltage threshold set by the R_{LIM} resistor to limit the inductor current on a cycle-by-cycle basis. The controller facilitates external compensation for enhanced flexibility.

Initialization

When the PWM is disabled, the SW node is connected to GND through an internal 500Ω MOSFET to slowly discharge the output. As long as the PWM controller is enabled, this internal MOSFET remains OFF.

Soft-Start (PWM and LDO)

When V_{CC} exceeds the UVLO threshold and EN is high, the circuit releases SS and enables the PWM regulator. The capacitor connected to the SS pin and GND is charged by a $10\mu A$ internal current source, causing the voltage on the capacitor to rise. When this voltage exceeds 1.2V, all protection circuits are enabled. When this voltage exceeds 2.2V, the LDO output is enabled. The input to the error amplifier at the non-inverting pin is clamped by the voltage on the SS pin until it crosses the reference voltage.

The time it takes the PWM output to reach regulation (T_{Rise}) is calculated using the following equation:

$$T_{RISE} = 8 \times 10^{-2} \times C_{SS} \quad (C_{SS} \text{ is in } \mu\text{f}) \quad (\text{EQ. 1})$$

Oscillator Clock Frequency (PWM)

The clock frequency on the oscillator is set using an external resistor, connected between R(T) pin and ground. The frequency follows the graph, as shown in Figure 18. The minimum clock frequency is 50kHz, which is when R(T) pin is left open. Select the value of R(T) as shown in the equation below. This equation is valid for all $F_{OSC} > 50\text{kHz}$:

$$R(t) = \frac{4 \times 10^7}{6.25 \times F_{OSC} - 2.99 \times 10^5} \text{k}\Omega \quad (\text{EQ. 2})$$

where, F_{OSC} is in Hz.

For example, for $F_{OSC} = 80\text{kHz}$, $R(t) = 199\text{k}\Omega$.

R_{RAMP} Selection and Feedforward Operation

The FAN5099 provides for input voltage feedforward compensation through R_{RAMP} . The value of R_{RAMP} effec-

tively changes the slope of the internal ramp, minimizing the variation of the PWM modulator gain when input voltage varies. The R_{RAMP} effect on the current limit is explained in later sections. The R_{RAMP} value can be approximated using the following equation:

$$R_{RAMP} = \frac{V_{(IN, nom)} - 1.8}{6.3 \times 10^{-8} \times F_{OSC}} \text{k}\Omega \quad (\text{EQ. 3})$$

where F_{OSC} is in Hz. For example, for $F_{OSC} = 80\text{kHz}$ and $V_{IN} = 12\text{V}$, $R_{RAMP} = 2\text{M}\Omega$.

Gate Drive Section

The adaptive gate control logic translates the internal PWM control signal into the MOSFET gate drive signals and provides necessary amplification, level shifting, and shoot-through protection. It also has functions that help optimize the IC performance over a wide range of operating conditions. Since the MOSFET switching time can vary dramatically from device to device and with the input voltage, the gate control logic provides adaptive dead time by monitoring the gate-to-source voltages of both upper and lower MOSFETs. The lower MOSFET drive is not turned on until the gate-to-source voltage of the upper MOSFET has decreased to less than approximately 1V. Similarly, the upper MOSFET is not turned on until the gate-to-source voltage of the lower MOSFET has decreased to less than approximately 1V. This allows a wide variety of upper and lower MOSFETs to be used without a concern for simultaneous conduction, or shoot-through.

A low impedance path between the driver pin and the MOSFET gate is recommended for the adaptive dead-time circuit to work properly. Any delay along this path reduces the delay generated by the adaptive dead-time circuit, thereby increasing the chances for shoot-through.

Protection

In the FAN5099, the converter is protected against overload, short-circuit, over-voltage, and under-voltage conditions. All of these extreme conditions generate an internal "fault latch" which shuts down the converter. For all fault conditions, both the high-side and the low-side drives are off, except in the case of OVP, where the low-side MOSFET is turned on until the voltage on the FB pin goes below 0.4V. The fault latch can be reset either by toggling the EN pin or recycling V_{CC} to the chip.

Over-Current Limit (PWM)

The PWM converter is protected against overloading through a cycle-by-cycle current limit set by selecting R_{ILIM} resistor. An internal $10\mu A$ current source sets the threshold voltage for the output of the summing amplifier. When the summing amplifier output exceeds this threshold level, the current limit comparator trips and the PWM starts skipping pulses. If the current limit tripping occurs for 16 continuous clock cycles, a fault latch is set and the

controller shuts down the converter. This shutdown feature is disabled during the start-up until the voltage on the SS capacitor crosses 1.2V.

To achieve current limit, the FAN5099 monitors the inductor current during the OFF time by monitoring and holding the voltage across the lower MOSFET. The voltage across the lower MOSFET is sensed between the PGND and the SW pins.

The output of the summing amplifier is a function of the inductor current, R_{DS_ON} of the bottom FET and the gain of the current sense amplifier. With the R_{DS_ON} method of current sensing, the current limit can vary widely from unit to unit. R_{DS_ON} not only varies from unit to unit, but also has a typical junction temperature coefficient of about 0.4%/°C (consult the MOSFET datasheet for actual values). The set point of the actual current limit decreases in proportion to increase in MOSFET die temperature. A factor of 1.6 in the current limit set point typically compensates for all MOSFET R_{DS_ON} variations, assuming the MOSFET's heat sinking keeps its operating die temperature below 125°C.

For more accurate current limit setting, use resistor sensing. In a resistor sensing scheme, an appropriate current sense resistor is connected between the source terminal of the bottom MOSFET and PGND.

Set the current limit by choosing R_{ILIM} as follows:

$$R_{ILIM} = \left[128 + \frac{K1 \cdot I_{MAX} \cdot R_{DS(ON)} \cdot 10^3}{1.43} + \left(\left(1 - \frac{1.8}{V_{IN}} \right) \cdot \frac{V_{OUT} \cdot 33.32 \cdot 10^{11}}{F_{SW} \cdot R_{RAMP}} \right) \right] \quad (EQ. 4)$$

where:

R_{ILIM} is in $K\Omega$.

I_{MAX} is the maximum load current.

$K1$ is a constant to accommodate for the variation of MOSFET $R_{DS(ON)}$ (typically 1.6).

With $K1 = 1.6$, $I_{MAX} = 20A$, $R_{DS(ON)} = 7m\Omega$, $V_{IN} = 24V$, $V_{OUT} = 1.5V$, $F_{SW} = 300\text{ kHz}$, $R_{RAMP} = 400\text{ K}\Omega$, R_{ILIM} calculates to be 323.17K Ω .

Auto Restart (PWM)

The FAN5099 supports two modes of response when the internal fault latch is set. The user can configure it to keep the power supply latched in the OFF state OR in the auto restart mode. When the EN pin is tied to V_{CC} , the power supply is latched OFF. When the EN pin is terminated with a 100nF to GND, the power supply is in auto restart mode. The table below describes the relationship between PWM restart and setting on EN pin. Do not leave the EN pin open without any capacitor.

EN Pin	PWM/Restart
Pull to GND	OFF
V_{CC}	No restart after fault
Cap to GND	Restart after $t_{DELAY} (\text{Sec.}) = 0.85 \times C$ where C is in μF

The fault latch can also be reset by recycling the V_{CC} to the controller.

Under Voltage Protection (PWM)

The PWM converter output is monitored constantly for under voltage at the FB pin. If the voltage on the FB pin stays lower than 75% of internal V_{REF} for 16 clock cycles, the fault latch is set and the converter shuts down. This shutdown feature is disabled during startup until the voltage on the SS capacitor reaches 1.2V.

Over-Voltage Protection (PWM)

The PWM converter output voltage is monitored constantly at the FB pin for over voltage. If the voltage on the FB pin stays higher than 115% of internal V_{REF} for two-clock cycles, the controller turns OFF the upper MOSFET and turns ON the lower MOSFET. This crowbar action stops when the voltage on the FB pin comes down to 0.4V to prevent the output voltage from becoming negative. This over-voltage protection (OVP) feature is active when the voltage on the EN pin becomes HIGH.

Turning ON the low-side MOSFETs on an OVP condition pulls down the output, resulting in a reverse current, which starts to build up in the inductor. If the output over-voltage is due to failure of the high-side MOSFET, this crowbar action pulls down the input supply or blows its fuse, protecting the system, which is very critical.

During soft-start, if the output overshoots beyond 115% of V_{REF} , the output voltage is brought down by the low-side MOSFET until the voltage on the FB pin goes below 0.4V. The fault latch is NOT set until the voltage on the SS pin reaches 1.2V. Once the fault latch is set, the converter shuts down.

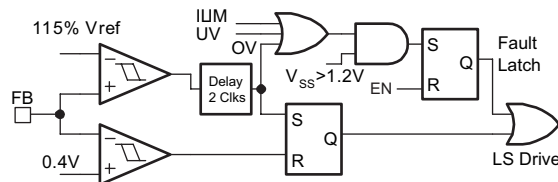

Figure 22. Over-Voltage Protection

Thermal Fault Protection

The FAN5099 features thermal protection where the IC temperature is monitored. When the IC junction temperature exceeds +160°C, the controller shuts down and when the junction temperature gets down to +125°C, the converter restarts.

LDO Section

The LDO controller is designed to provide ultra low voltages, as low as 0.8V for GTL-type loads. The regulating loop employs a very fast response feedback loop and small capacitors can be used to keep track of the changing output voltage during transients. For stable operation, the minimum capacitance on the output needs to be 100µF and the typical ESR needs to be around 100mΩ.

The maximum voltage at the gate drive for the MOSFET can reach close to 0.5V below the V_{CC} of the controller. For example, for a 1.2V output, the minimum enhancement voltage required with 4.75V on V_{CC} is 3.05V (4.75V-0.5V-1.2V = 3.05V). The dropout voltage for the LDO is dependent on the load current and the MOSFET chosen. It is recommended to use low enhancement voltage MOSFETs for the LDO. In an application where LDO is not needed, pull up the FBLDO pin (Pin 1) higher than 1V to disable the LDO.

The soft-start on the LDO output (ramp) is controlled by the capacitor on the SS pin to GND. The LDO output is enabled only when the voltage on the SS pin reaches 2.2V. Refer to Figure 9 for startup waveform.

Design Section

General Design Guidelines

Establishing the input voltage range and the maximum current loading on the converter before choosing the switching frequency and the inductor ripple current is highly recommended. There are design tradeoffs choosing optimum switching frequency and ripple current.

The input voltage range should accommodate the worst-case input voltage with which the converter may ever operate. This voltage needs to account for the cable drop encountered from the source to the converter. Typically, the converter efficiency tends to be higher at lower input voltage conditions.

When selecting maximum loading conditions, consider the transient and steady-state (continuous) loading separately. The transient loading affects the selection of the inductor and the output capacitors. Steady-state loading affects the selection of MOSFETs, input capacitors, and other critical heat-generating components.

The selection of switching frequency is challenging. While higher switching frequency results in smaller components, it also results in lower efficiency. Ideal selection of switching frequency takes into account the maximum operating voltage. The MOSFET switching losses are directly proportional to F_{SW} and the square function of the input voltage.

When selecting the inductor, consider the minimum and maximum load conditions. Lower inductor values produce better transient response, but result in higher ripple and lower efficiency due to high RMS currents. Optimum minimum inductance value enables the converter to

operate at the boundary of continuous and discontinuous conduction modes.

Setting the Output Voltage (PWM)

The internal reference for the PWM controller is at 0.8V. The output voltage of the PWM regulator can be set in the range of 0.8V to 90% of its power input by an external resistor divider. The output is divided down by an external voltage divider to the FB pin (for example, R1 and R_{BIAS} as in Figure 25). The output voltage is given by the following equation:

$$V_{OUT} = 0.8V \times \left(1 + \frac{R1}{R_{BIAS}}\right) \quad (\text{EQ. 5})$$

To minimize noise pickup on this node, keep the resistor to GND (R_{BIAS}) below 10KΩ.

Inductor Selection (PWM)

When the ripple current, switching frequency of the converter, and the input-output voltages are established, select the inductor using the following equation:

$$L_{MIN} = \frac{\left(V_{OUT} - \frac{V_{OUT}^2}{V_{IN}}\right)}{I_{Ripple} \times F_{SW}} \quad (\text{EQ. 6})$$

where I_{Ripple} is the ripple current.

This number typically varies between 20% to 50% of the maximum steady-state load on the converter.

When selecting an inductor from the vendors, select the inductance value which is close to the value calculated at the rated current (including half the ripple current).

Input Capacitor Selection (PWM)

The input capacitors must have an adequate RMS current rating to withstand the temperature rise caused by the internal power dissipation. The combined RMS current rating for the input capacitor should be greater than the value calculated using the following equation:

$$I_{INPUT(RMS)} = I_{LOAD(MAX)} \times \left(\sqrt{\frac{V_{OUT}}{V_{IN}} - \left(\frac{V_{OUT}}{V_{IN}}\right)^2}\right) \quad (\text{EQ. 7})$$

Common capacitor types used for such application include aluminum, ceramic, POS CAP, and OSCON.

Output Capacitor Selection (PWM)

The output capacitors chosen must have low enough ESR to meet the output ripple and load transient requirements. The ESR of the output capacitor should be lower than both of the values calculated below to satisfy both the transient loading and steady-state ripple conditions as given by the following equation:

$$ESR \leq \frac{V_{STEP}}{\Delta I_{LOAD(MAX)}} \quad \text{and} \quad ESR \leq \frac{V_{Ripple}}{I_{Ripple}} \quad (\text{EQ. 8})$$

In the case of aluminum and polymer-based capacitors, the output capacitance is typically higher than normally required to meet these requirements. While selecting the ceramic capacitors for the output; although lower ESR can be achieved easily, higher capacitance values are required to meet the $V_{OUT(MIN)}$ restrictions during a load transient. From the stability point of view, the zero caused by the ESR of the output capacitor plays an important role in the stability of the converter.

Output Capacitor Selection (LDO)

For stable operation, the minimum capacitance of 100 μ F with ESR around 100m Ω is recommended. For other values, contact the factory.

Power MOSFET Selection (PWM)

The FAN5099 is capable of driving N-Channel MOSFETs as circuit switch elements. For better performance, MOSFET selection should address these key parameters:

- The maximum Drain-to-Source Voltage (V_{DS}) should be at least 25% higher than the worst-case input voltage.
- The MOSFETs should have low Q_G , Q_{GD} , and Q_{GS} .
- The R_{DS_ON} of the MOSFETs should be as low as possible.

In typical applications for a buck converter, the duty cycles are lower than 20%. To optimize the selection of MOSFETs for both the high-side and low-side, follow different selection criteria. Select the high-side MOSFET to minimize the switching losses and the low-side MOSFET to minimize the conduction losses due to the channel and the body diode losses. Note that the gate drive losses also affect the temperature rise on the controller.

For loss calculation, refer to Fairchild's Application Note AN-6005 and the associated spreadsheet.

High-Side Losses

To understand losses in the MOSFET, follow the MOSFET switching interval shown in Figure 23. The MOSFET gate drive equivalent circuit is shown in Figure 24.

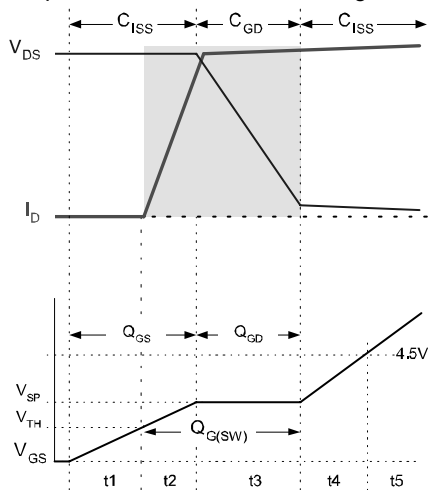

Figure 23. Switching Losses and Q_g

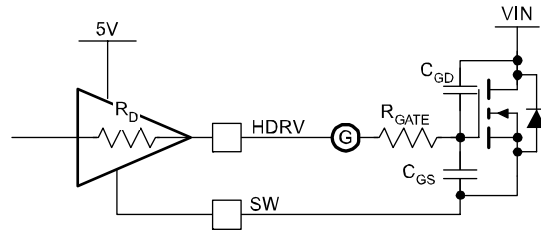

Figure 24. Drive Equivalent Circuit

The upper graph in Figure 23 represents Drain-to-Source Voltage (V_{DS}) and Drain Current (I_D) waveforms. The lower graph details Gate-to-Source Voltage (V_{GS}) versus time with a constant current charging the gate. The x-axis is representative of Gate Charge (Q_G). $C_{ISS} = C_{GD} + C_{GS}$ and controls t_1 , t_2 , and t_4 timing. C_{GD} receives current from the gate driver during t_3 (as V_{DS} is falling). Obtain the gate charge (Q_G) parameters shown on the lower graph from the MOSFET datasheets.

Assuming switching losses are about the same for both the rising edge and falling edge, Q1's switching losses occur during the shaded time when the MOSFET has voltage across it and current through it.

Losses are given by Equations 9-11:

$$P_{UPPER} = P_{SW} + P_{COND} \quad (EQ. 9)$$

$$P_{SW} = \left(\frac{V_{DS} \times I_L}{2} \times 2 \times t_s \right) F_{SW} \quad (EQ. 10)$$

$$P_{COND} = \left(\frac{V_{OUT}}{V_{IN}} \right) \times I_{OUT}^2 \times R_{DS(ON)} \quad (EQ. 11)$$

where P_{UPPER} is the upper MOSFET's total losses and P_{SW} and P_{COND} are the switching and conduction losses for a given MOSFET $R_{DS(ON)}$ is at the maximum junction temperature (T_J) and t_s is the switching period (rise or fall time) and equals t_2+t_3 , as shown in Figure 23.

The driver's impedance and C_{ISS} determine t_2 while t_3 's period is controlled by the driver's impedance and Q_{GD} . Since most of t_s occurs when $V_{GS} = V_{SP}$, assume a constant current for the driver to simplify the calculation of t_s with the following equation:

$$t_s = \frac{Q_{G(SW)}}{I_{Driver}} \approx \frac{Q_{G(SW)}}{\left(\frac{V_{CC} - V_{SP}}{R_{Driver} + R_{Gate}} \right)} \quad (EQ. 12)$$

Most MOSFET vendors specify Q_{GD} and Q_{GS} . $Q_{G(SW)}$ can be determined as:

$Q_{G(SW)} = Q_{GD} + Q_{GS} - Q_{TH}$ where Q_{TH} is the gate charge required to reach the MOSFET threshold (V_{TH}).

Note that for the high-side MOSFET, V_{DS} equals V_{IN} , which can be as high as 20V in a typical portable application. Include the power delivered to the MOSFET's (P_{GATE}) in calculating the power dissipation required for the FAN5099.

P_{GATE} is determined by the following equation:

$$P_{Gate} = Q_G \times V_{CC} \times F_{SW} \quad (EQ. 13)$$

where Q_G is the total gate charge to reach V_{CC} .

Low-Side Losses

Q2 switches on or off with its parallel Schottky diode simultaneously conducting, so the $V_{DS} \approx 0.5V$. Since P_{SW} is proportional to V_{DS} , Q2's switching losses are negligible and Q2 is selected based on $R_{DS(ON)}$ alone.

Conduction losses for Q2 are given by the equation:

$$P_{COND} = (1 - D) \times I_{OUT}^2 \times R_{DS(ON)} \quad (EQ. 14)$$

where $R_{DS(ON)}$ is the $R_{DS(ON)}$ of the MOSFET at the highest operating junction temperature and $D=V_{OUT}/V_{IN}$ is the minimum duty cycle for the converter.

Since $D_{MIN} < 20\%$ for portable computers, $(1-D) \approx 1$ produces a conservative result, simplifying the calculation.

The maximum power dissipation ($P_{D(MAX)}$) is a function of the maximum allowable die temperature of the low-side MOSFET, the θ_{JA} , and the maximum allowable ambient temperature rise. $P_{D(MAX)}$ is calculated using the following equation:

$$P_{D(MAX)} = \frac{T_{J(MAX)} - T_{A(MAX)}}{\theta_{JA}} \quad (EQ. 15)$$

θ_{JA} depends primarily on the amount of PCB area devoted to heat sinking.

Selection of MOSFET Snubber Circuit

The switch node (SW) ringing is caused by fast switching transitions due to energy stored in parasitic elements. This ringing on the SW node couples to other circuits around the converter if they are not handled properly. To dampen ringing, an R-C snubber is connected across the SW node and the source of the low-side MOSFET.

R-C components for the snubber are selected as follows:

a) Measure the SW node ringing frequency (F_{ring}) with a low capacitance scope probe.

b) Connect a capacitor (C_{SNUB}) from SW node to GND so that it reduces this ringing by half.

c) Place a resistor (R_{SNUB}) in series with this capacitor. R_{SNUB} is calculated using the following equation:

$$R_{SNUB} = \frac{2}{\pi \times F_{ring} \times C_{SNUB}} \quad (EQ. 16)$$

d) Calculate the power dissipated in the snubber resistor as shown in the following equation:

$$P_{R(SNUB)} = C_{SNUB} \times V_{IN(MAX)}^2 \times F_{SW} \quad (EQ. 17)$$

where, $V_{IN(MAX)}$ is the maximum input voltage and F_{SW} is the converter switching frequency.

The snubber resistor chosen should be de-rated to handle the worst-case power dissipation. **Do not use wire-wound resistors for R_{SNUB} .**

Loop Compensation

Typically, the closed-loop crossover frequency (F_{cross}), where the overall gain is unity, should be selected to achieve optimal transient and steady-state response to disturbances in line and load conditions. It is recommended to keep F_{cross} below one-fifth of the switching frequency of the converter. Higher phase margin tends to have a more stable system with more sluggish response to load transients. Optimum phase margin is about 60° , a good compromise between steady-state and transient responses. A typical design should address variations over a wide range of load conditions and over a large sample of devices.

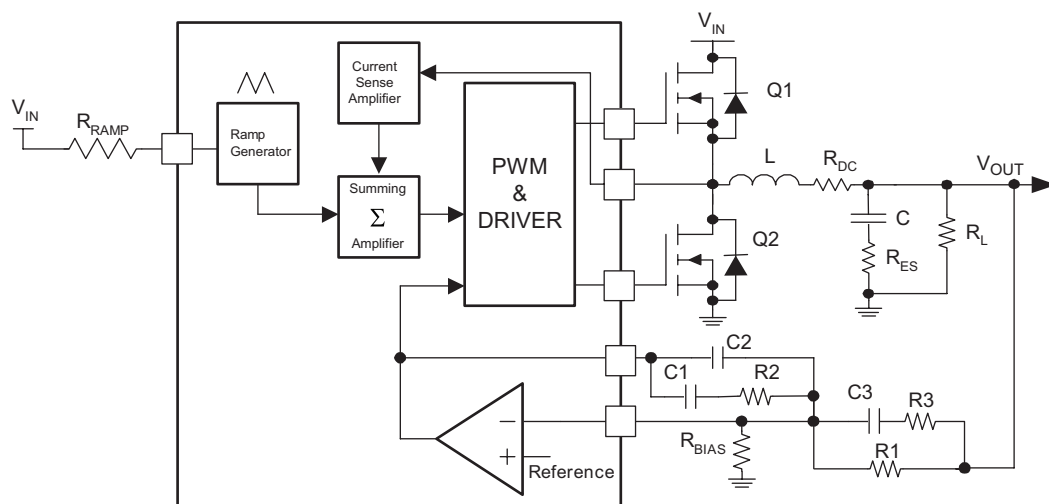

Figure 25. Closed-Loop System with Type-3 Network

FAN5099 has a high gain error amplifier around which the loop is closed. Figure 25 shows a type-3 compensation network. For type-2 compensation, R3 and C3 are not used. Since the FAN5099 architecture employs summing current mode, type-2 compensation can be used for most applications. For further information about type-2 compensation networks, refer to the following:

- Venable, H. Dean, "The K factor: A new mathematical tool for stability analysis and synthesis," *Proceedings of Powercon, March 1983.*

Note: For critical applications requiring wide loop bandwidth using very low ESR output capacitors, use type-3 compensation.

Type-3 Feedback Component Calculations

Use these steps to calculate feedback components:

Notation:

C_0 = Net Output Filter Capacitance

$G_p(s)$ = Net Gain of Plant = control-to-output transfer function

L = Inductor Value

R_{DSON} = On-State Drain-to Source Resistance of Low-side MOSFET

R_{es} = Net ESR of the output filter capacitors

R_L = Load Resistance

T_s = Switching Period

V_i = Input Voltage

F_{SW} = Switching Frequency

Equations:

$$\text{Effective current sense resistance} = R_i = 7 \times R_{\text{DSON}} \quad (\text{EQ. 18})$$

$$\text{Current modulator DC gain} = M_i = \frac{R_L}{R_i} \quad (\text{EQ. 19})$$

$$\text{Effective ramp amplitude} = V_m = 3.33 \times 10^{10} \times \frac{(V_i - 1.8) \times T_s}{R_{\text{ramp}}} \quad (\text{EQ. 20})$$

$$\text{Voltage modulator DC gain} = M_v = \frac{V_i}{V_m} \quad (\text{EQ. 21})$$

$$\text{Plant DC gain} = M_o = M_v \parallel M_i = \frac{M_v \times M_i}{M_v + M_i} \quad (\text{EQ. 22})$$

$$\text{Sampling gain natural frequency} = \omega_n = \frac{\pi}{T_s} \quad (\text{EQ. 23})$$

$$\text{Effective inductance} = L_e = \frac{M_o}{M_v} \times \left(L + \frac{M_v \times R_i}{\omega_n \times Q_z} \right) \quad (\text{EQ. 24})$$

$$R_p = \frac{M_v \times R_i \times R_L}{M_v \times R_i + R_L} = (M_v \times R_i) \parallel R_L \quad (\text{EQ. 25})$$

Poles and Zeros of Plant Transfer Function:

$$\text{Plant zero frequency} = f_z = \frac{1}{2 \times \pi \times C_o \times R_{es}} \quad (\text{EQ. 26})$$

$$\text{Plant 1st pole frequency} = f_{p1} = \frac{1}{2 \times \pi \times \left(C_o \times R_p + \frac{L_e}{R_L} \right)} \quad (\text{EQ. 27})$$

$$\text{Plant 2nd pole frequency} = f_{p2} = \frac{1}{2 \times \pi} \times \left(\frac{1}{C_o \times R_L} + \frac{R_p}{L_e} \right) \quad (\text{EQ. 28})$$

$$\text{Plant 3rd pole frequency} = f_{p3} = \frac{\omega_n^2 \times L_e}{2 \times \pi \times R_p} \quad (\text{EQ. 29})$$

Plant gain (magnitude) response:

$$|G_p|(f) = 20 \times \log M_0 + 10 \times \log \left[\frac{1 + \left(\frac{f}{f_z} \right)^2}{\left[1 + \left(\frac{f}{f_{p1}} \right)^2 \right] \times \left[1 + \left(\frac{f}{f_{p2}} \right)^2 \right] \times \left[1 + \left(\frac{f}{f_{p3}} \right)^2 \right]} \right] \quad (\text{EQ. 30})$$

Plant phase response:

$$\angle G_p(f) = \tan^{-1} \left(\frac{f}{f_z} \right) - \tan^{-1} \left(\frac{f}{f_{p1}} \right) - \tan^{-1} \left(\frac{f}{f_{p2}} \right) - \tan^{-1} \left(\frac{f}{f_{p3}} \right) \quad (\text{EQ. 31})$$

Choose R1, R_{BIAS} to set the output voltage using EQ.5. Choose the zero crossover frequency F_{cross} of the overall loop. Typically F_{cross} should be less than 1/5th of F_{sw}. Choose the desired phase margin. Typically this number should be between 60° to 90°.

Calculate plant gain at F_{cross} using EQ.30 by substituting F_{cross} in place of f. The gain that the amplifier needs to provide to get the required crossover is given by:

$$G_{AMP} = \frac{1}{|G_p|(F_{cross})} \quad (\text{EQ. 32})$$

The phase boost required is calculated as given in (EQ. 33).

$$\text{Phase Boost} = M - \angle G_p(F_{cross}) - 90^\circ \quad (\text{EQ. 33})$$

where M is the desired phase margin in degrees.

The feedback component values are now calculated as given in equations below:

$$K = \left\{ \tan \left[\left(\frac{\text{Boost}}{4} \right) + 45 \right] \right\}^2 \quad (\text{EQ. 34})$$

$$C2 = \frac{1}{2 \times \pi \times F_{cross} \times G_{AMP} \times R1} \quad (\text{EQ. 35})$$

$$C1 = C2 \times (K - 1) \quad (\text{EQ. 36})$$

$$C3 = \frac{1}{2 \times \pi \times F_{cross} \times \sqrt{K} \times R3} \quad (\text{EQ. 37})$$

$$R2 = \frac{\sqrt{K}}{2 \times \pi \times F_{cross} \times C1} \quad (\text{EQ. 38})$$

$$R3 = \frac{R1}{(K - 1)} \quad (\text{EQ. 39})$$

Design Tools

Fairchild application note **AN-6020** provides a PSPICE model and spreadsheet calculator for the PWM regulator, simplifying external component selections and verifying loop stability. The topics covered in the datasheet provide an understanding behind the calculations in the spreadsheet.

The spreadsheet calculator, which is part of **AN-6020** can be used to calculate all external component values for designing around FAN5099. The spreadsheet provides optimized compensation components and generates a Bode plot to ensure loop stability.

Based on the input values entered, **AN-6020's** PSPICE model can be used to simulate Bode plots (for loop stability) as well as transient analysis that help customize the design for a wide range of applications.

Use Fairchild application note **AN-6005** for prediction of the losses and die temperatures for the power semiconductors used in the circuit.

Both **AN-6020** and **AN-6005** can be downloaded from www.fairchildsemi.com/apnotes/.

Layout Considerations

The switching power converter layout needs careful attention and is critical to achieving low losses and clean and stable operation. Below are specific recommendations for a good board layout:

- Keep the high current traces and load connections as short as possible.
- Use thick copper boards whenever possible to achieve higher efficiency.
- Keep the loop area between the SW node, low-side MOSFET, inductor, and the output capacitor as small as possible.
- Route high dV/dt signals, such as SW node, away from the error amplifier input/output pins. Keep components connected to these pins close to the pins.
- Place ceramic de-coupling capacitors very close to V_{CC} pin.
- All input signals are referenced with respect to AGND pin. Dedicate one layer of the PCB for a GND plane. Use at least four layers for the PCB.
- Minimize GND loops in the layout to avoid EMI-related issues.
- Use wide traces for the lower gate drive to keep the drive impedances low.
- Connect PGND directly to the lower MOSFET source pin.
- Use wide land areas with appropriate thermal vias to effectively remove heat from the MOSFETs.
- Use snubber circuits to minimize high-frequency ringing at the SW nodes.
- Place the output capacitor for the LDO close to the source of the LDO MOSFET.

Application Board Schematic

$V_{IN} = 3 \text{ to } 24\text{V}$; $V_{OUT} = 1.5\text{V at } 20\text{A}$; $F_{OSC} = 300\text{kHz}$.

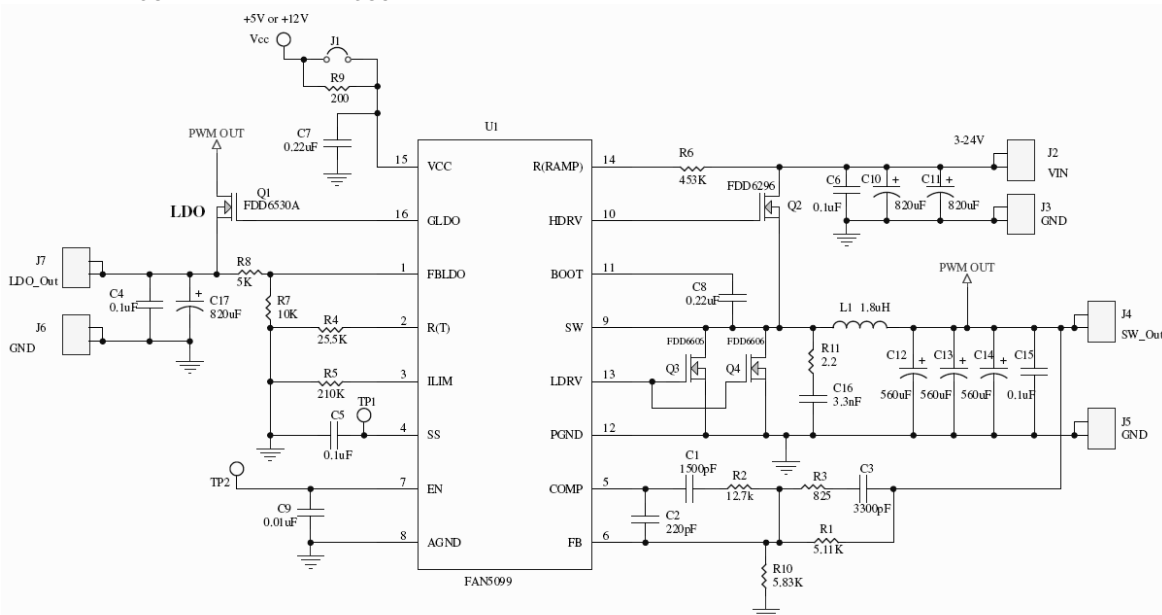

Figure 26. Application Board Schematic

Bill of Materials

Part Description	Quantity	Designator	Vendor	Vendor Part Number
Capacitor, 1500pF, 10%, 50V, 0603, X7R	1	C1	Panasonic	ECJ1VB1H152K
Capacitor, 220pF, 5%, 50V, 0603, NPO	1	C2	Panasonic	ECJ1VC1H221J
Capacitor, 3300pF, 10%, 50V, 0603, X7R	1	C3	Panasonic	ECJ1VB1H332K
Capacitor, 0.1μF, 10%, 25V, 0603, X7R	4	C4, C5, C6, C15	Panasonic	ECJ1VB1E104K
Capacitor, 0.22μF, 20%, 25V, 0603, X7R	2	C7, C8	TDK	C1608JB1E224K
Capacitor, 0.01μF, 10%, 50V, 0603, X7R	1	C9	Panasonic	ECJ1VB1H103K
Capacitor, 820μF, 20%, 10X20, 25V, 20mΩ, 1.96A	2	C10, C11	Nippon-Chemicon	KZH25VB820MHJ20
Capacitor, 820μF, 20%, 8X8, 2.5V, 7mΩ, 6.1A	1	C17	Nippon-Chemicon	PSC2.5VB820MH08
Capacitor, 560μF, 20%, 8X11.5, 4V, 7mΩ, 5.58A	3	C12, C13, C14	Nippon-Chemicon	PSA4VB560MH11
Capacitor, 3300pF, 10%, 50V, 0805, X7R	1	C16	Panasonic	ECJ2VB1H332K
Connector Header 0.100 Vertical, Tin – 2 Pin	1	J1	Molex	22-28-4360
Terminal Quickfit Male .052" Dia. 187" Tab	6	J2–J7	Keystone	1212
Inductor, 1.8μH, 20%, 26Amps Max, 3.24mΩ	1	L1	Inter-Technical	SC5018-1R8M
MOSFET N-CH, 32mΩ, 20V, 21A, D-PAK, FSID: FDD6530A	1	Q1	Fairchild Semiconductor	FDD6530A
MOSFET N-CH, 8.8mΩ, 30V, 50A, D-PAK, FSID: FDD6296	1	Q2	Fairchild Semiconductor	FDD6296
MOSFET N-CH, 6mΩ, 30V, 75A, D-PAK, FSID: FDD6606	2	Q3, Q4	Fairchild Semiconductor	FDD6606
Resistor, 5.11k, 1%, 1/16W	1	R1	Panasonic	ERJ3EKF5111V
Resistor, 12.7k, 1%, 1/16W	1	R2	Panasonic	ERJ3EKF1272V
Resistor, 825, 1%, 1/16W	1	R3	Panasonic	ERJ3EKF8250V
Resistor, 25.5k, 1%, 1/16W	1	R4	Panasonic	ERJ3EKF2552V
Resistor, 210k, 1%, 1/16W	1	R5	Panasonic	ERJ3EKF2103V
Resistor, 453k, 1%, 1/16W	1	R6	Panasonic	ERJ3EKF453V
Resistor, 10k, 1%, 1/16W	1	R7	Panasonic	ERJ3EKF1002V
Resistor, 4.99k, 1%, 1/16W	1	R8	Panasonic	ERJ3EKF4991V
Resistor, 200, 1%, 1/4W	1	R9	Panasonic	ERJ8ENF2000V
Resistor, 5.90k, 1%, 1/16W	1	R10	Panasonic	ERJ3EKF5901V
Resistor, 2.2, 1%, 1/4W	1	R11	Panasonic	ERJ8RQF2R2V
Connector Header 0.100 Vertical, Tin – 1 Pin	3	TP1, TP2, Vcc	Molex	22-28-4360
IC, System Regulator, TSSOP16, FSID: FAN5099	1	U1	Fairchild Semiconductor	FAN5099

Application Board Schematic

$V_{IN} = 3$ to $24V$; $V_{OUT} = 1.5V$ at $20A$; $F_{OSC} = 80kHz$.

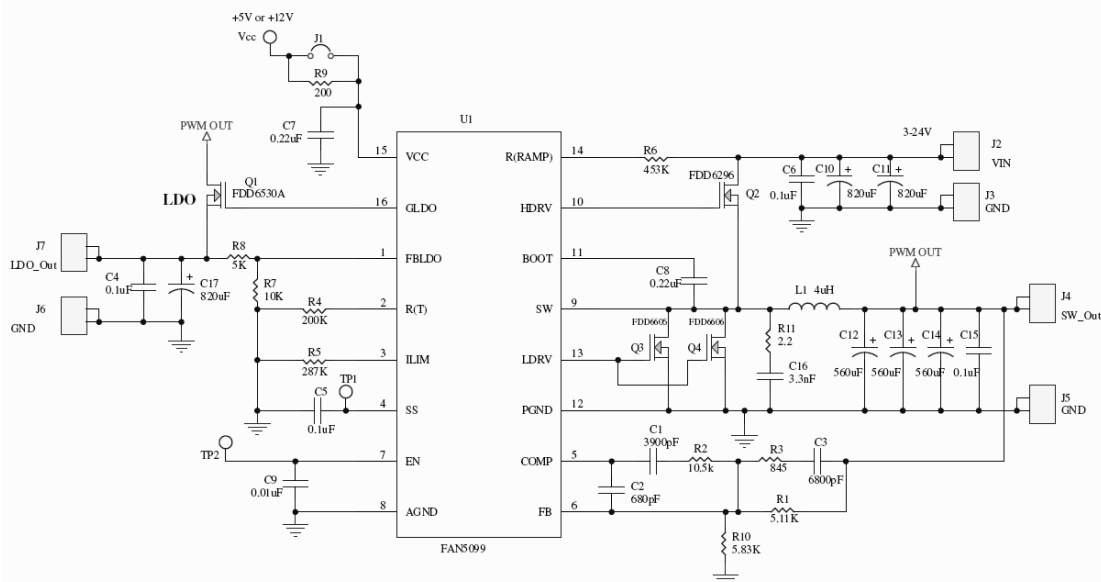

Figure 27. Application Board Schematic

Bill of Materials

Part Description	Quantity	Designator	Vendor	Vendor Part Number
Capacitor, 3900pF, 10%, 50V, 0603, X7R	1	C1	Panasonic	ECJ1VB1H392K
Capacitor, 680pF, 5%, 50V, 0603, NPO	1	C2	Panasonic	ECJ1VC1H681J
Capacitor, 6800pF, 10%, 50V, 0603, X7R	1	C3	Panasonic	ECJ1VB1H682K
Capacitor, 0.1μF, 10%, 25V, 0603, X7R	4	C4, C5, C6, C15	Panasonic	ECJ1VB1E104K
Capacitor, 0.22μF, 20%, 25V, 0603, X7R	2	C7, C8	TDK	C1608JB1E224K
Capacitor, 0.01μF, 10%, 50V, 0603, X7R	1	C9	Panasonic	ECJ1VB1H103K
Capacitor, 820μF, 20%, 10X20, 25V, 20mΩ, 1.96A	2	C10, C11	Nippon-Chemicon	KZH25VB820MHJ20
Capacitor, 820μF, 20%, 8X8, 2.5V, 7mΩ, 6.1A	1	C17	Nippon-Chemicon	PSC2.5VB820MH08
Capacitor, 560μF, 20%, 8X11.5, 4V, 7mΩ, 5.58A	3	C12, C13, C14	Nippon-Chemicon	PSA4VB560MH11
Capacitor, 3300pF, 10%, 50V, 0805, X7R	1	C16	Panasonic	ECJ2VB1H332K
Connector Header 0.100 Vertical, Tin – 2 Pin	1	J1	Molex	22-28-4360
Terminal Quickfit Male .052" Dia. 187" Tab	6	J2–J7	Keystone	1212
Inductor, 4.0μH@25A, 9.0μH@0A, 25A max, 4.4mΩ, wound on T80-52B core (Micrometals), 12 turns, 14 AWG wire	1	L1	Custom made	
MOSFET N-CH, 32mΩ, 20V, 21A, D-PAK, FSID: FDD6530A	1	Q1	Fairchild Semiconductor	FDD6530A
MOSFET N-CH, 8.8mΩ, 30V, 50A, D-PAK, FSID: FDD6296	1	Q2	Fairchild Semiconductor	FDD6296
MOSFET N-CH, 6mΩ, 30V, 75A, D-PAK, FSID: FDD6606	2	Q3, Q4	Fairchild Semiconductor	FDD6606
Resistor, 5.11k, 1%, 1/16W	1	R1	Panasonic	ERJ3EKF5111V
Resistor, 10.5k, 1%, 1/16W	1	R2	Panasonic	ERJ3EKF1052V
Resistor, 845, 1%, 1/16W	1	R3	Panasonic	ERJ3EKF8450V
Resistor, 200k, 1%, 1/16W	1	R4	Panasonic	ERJ3EKF2003V
Resistor, 287k, 1%, 1/16W	1	R5	Panasonic	ERJ3EKF2873V
Resistor, 453k, 1%, 1/16W	1	R6	Panasonic	ERJ3EKF453V
Resistor, 10k, 1%, 1/16W	1	R7	Panasonic	ERJ3EKF1002V
Resistor, 4.99k, 1%, 1/16W	1	R8	Panasonic	ERJ3EKF4991V
Resistor, 200, 1%, 1/4W	1	R9	Panasonic	ERJ8ENF2000V
Resistor, 5.90k, 1%, 1/16W	1	R10	Panasonic	ERJ3EKF5901V
Resistor, 2.2, 1%, 1/4W	1	R11	Panasonic	ERJ8RQF2R2V
Connector Header 0.100 Vertical, Tin – 1 Pin	3	TP1, TP2, Vcc	Molex	22-28-4360
IC, System Regulator, TSSOP16, FSID: FAN5099	1	U1	Fairchild Semiconductor	FAN5099

Typical Application Board Layout

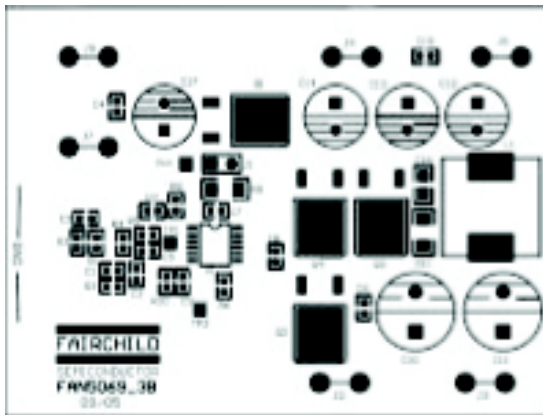

Figure 28. Assembly Diagram

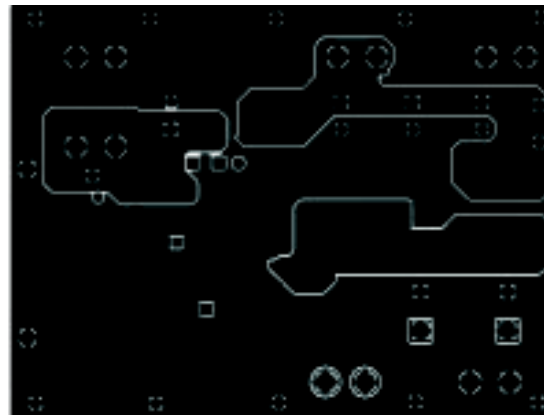

Figure 31. Mid Layer 2

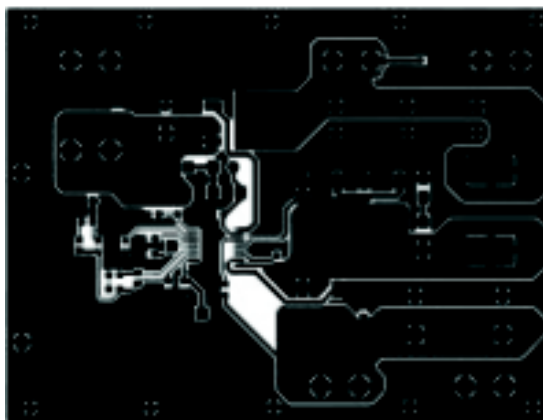

Figure 29. Top Layer

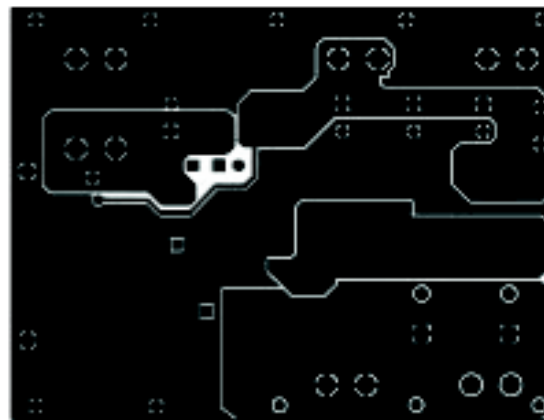

Figure 32. Bottom Layer

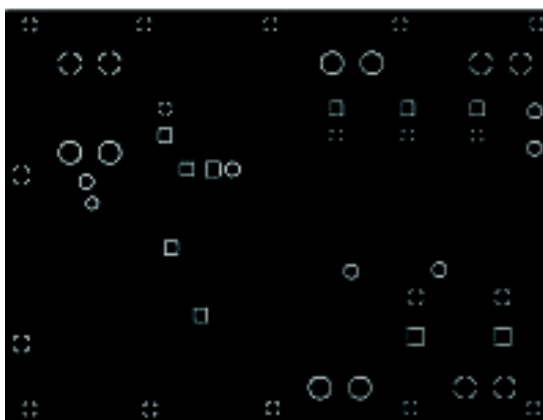

Figure 30. Mid Layer 1

Mechanical Dimensions

16-Lead TSSOP

All dimensions are in millimeters unless otherwise specified.

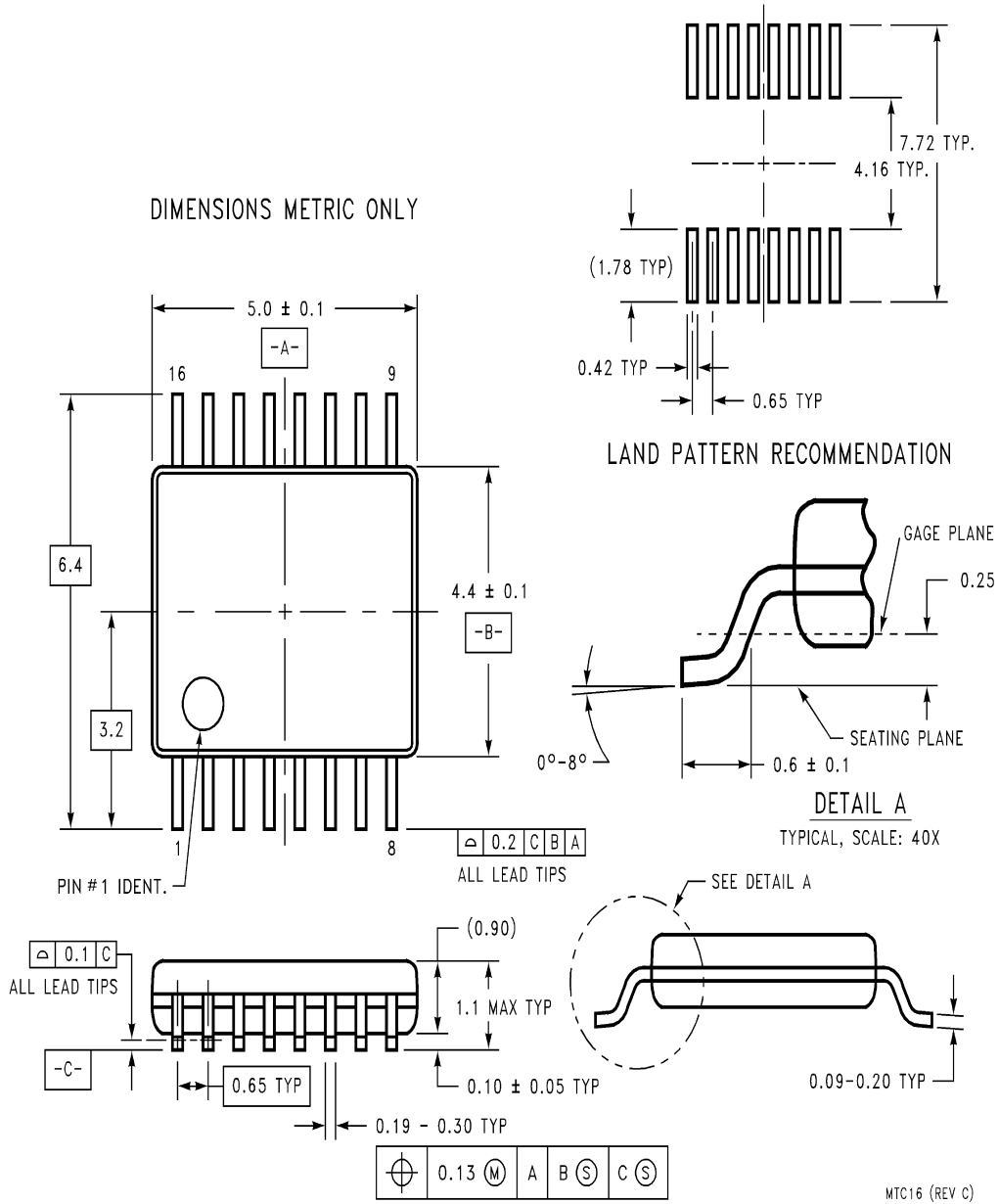
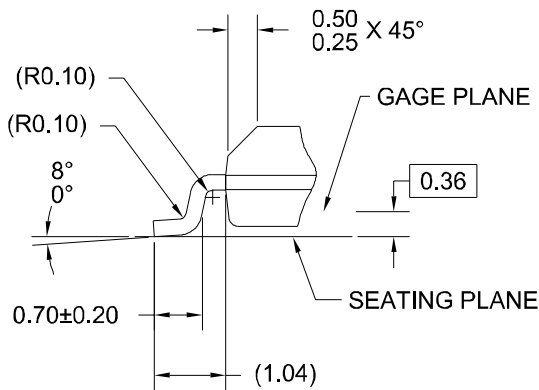
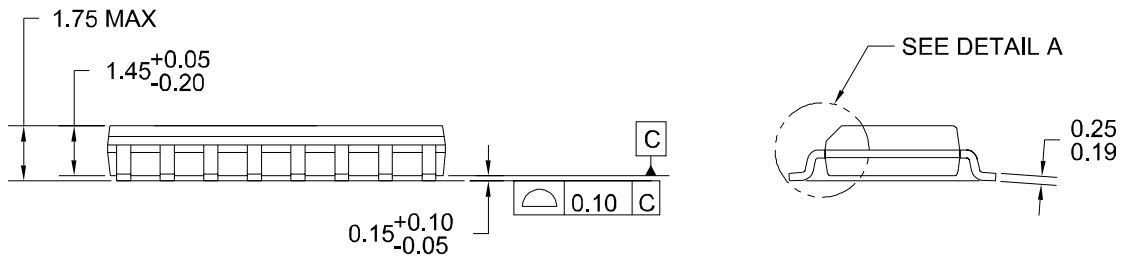
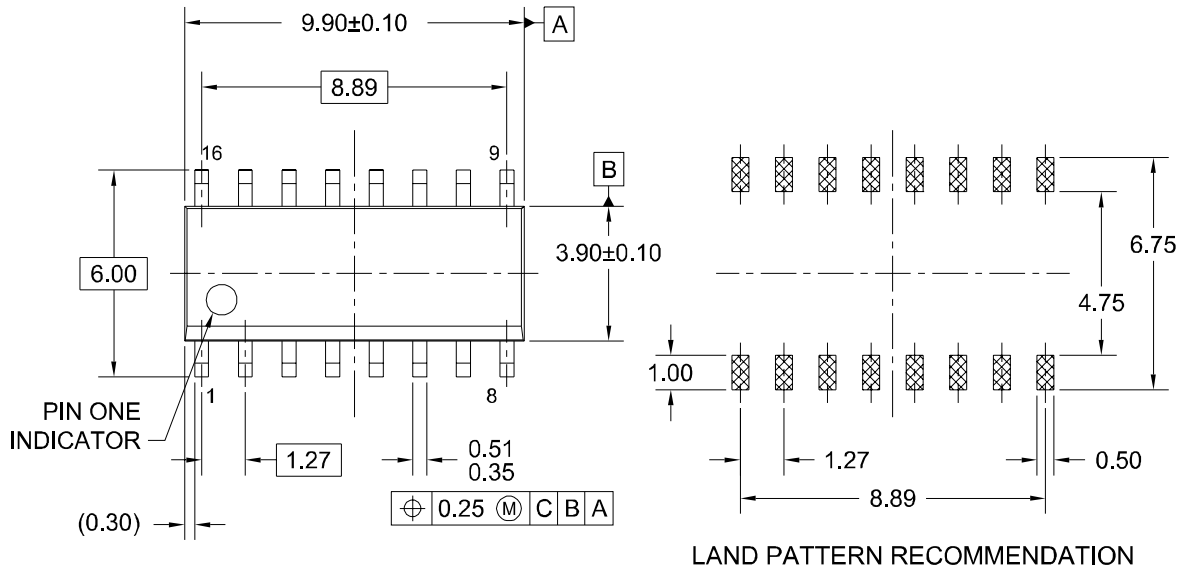

Figure 33. 16-Lead Thin Shrink Small Outline Package

Mechanical Dimensions (continued)

16-Lead SOIC

All dimensions are in millimeters unless otherwise specified.



DETAIL A
SCALE: 2:1

NOTES: UNLESS OTHERWISE SPECIFIED

- A) THIS PACKAGE CONFORMS TO JEDEC MS-012, VARIATION AC, ISSUE C, DATED MAY 1990.
- B) ALL DIMENSIONS ARE IN MILLIMETERS.
- C) DIMENSIONS DO NOT INCLUDE MOLD FLASH OR BURRS.
- D) STANDARD LEAD FINISH:
200 MICRONS / 5.08 MICRONS MIN.
LEAD/TIN (SOLDER) ON COPPER.

M16AREVK

Figure 34. 16-Lead Molded Small Outline Package

TRADEMARKS

The following are registered and unregistered trademarks Fairchild Semiconductor owns or is authorized to use and is not intended to be an exhaustive list of all such trademarks.

ACE ^x TM	FACT Quiet Series TM	OCX TM	SILENT SWITCHER [®]	UniFET TM
ActiveArray TM	GlobalOptoisolator TM	OCXPro TM	SMART START TM	VCX TM
Bottomless TM	GTO TM	OPTOLOGIC [®]	SPM TM	Wire TM
Build it Now TM	HiSeC TM	OPTOPLANAR TM	Stealth TM	
CoolFET TM	I ² C TM	PACMAN TM	SuperFET TM	
CROSSVOLT TM	i-Lo TM	POP TM	SuperSOT TM -3	
DOME TM	ImpliedDisconnect TM	Power247 TM	SuperSOT TM -6	
EcoSPARK TM	IntelliMAX TM	PowerEdge TM	SuperSOT TM -8	
E ² CMOS TM	ISOPLANAR TM	PowerSaver TM	SyncFET TM	
EnSigna TM	LittleFET TM	PowerTrench [®]	TCM TM	
FACT [®]	MICROCOUPLER TM	QFET [®]	TinyBoost TM	
FAST [®]	MicroFET TM	QS TM	TinyBuck TM	
FAST _r TM	MicroPak TM	QT Optoelectronics TM	TinyPWM TM	
FPS TM	MICROWIRE TM	Quiet Series TM	TinyPower TM	
FRFET TM	MSX TM	RapidConfigure TM	TinyLogic [®]	
	MSXPro TM	RapidConnect TM	TINYOPTO TM	
Across the board. Around the world. TM		μSerDes TM	TruTranslation TM	
The Power Franchise [®]		ScalarPump TM	UHC [®]	
Programmable Active Droop TM				

DISCLAIMER

FAIRCHILD SEMICONDUCTOR RESERVES THE RIGHT TO MAKE CHANGES WITHOUT FURTHER NOTICE TO ANY PRODUCTS HEREIN TO IMPROVE RELIABILITY, FUNCTION, OR DESIGN. FAIRCHILD DOES NOT ASSUME ANY LIABILITY ARISING OUT OF THE APPLICATION OR USE OF ANY PRODUCT OR CIRCUIT DESCRIBED HEREIN; NEITHER DOES IT CONVEY ANY LICENSE UNDER ITS PATENT RIGHTS, NOR THE RIGHTS OF OTHERS. THESE SPECIFICATIONS DO NOT EXPAND THE TERMS OF FAIRCHILD'S WORLDWIDE TERMS AND CONDITIONS, SPECIFICALLY THE WARRANTY THEREIN, WHICH COVERS THESE PRODUCTS.

LIFE SUPPORT POLICY

FAIRCHILD'S PRODUCTS ARE NOT AUTHORIZED FOR USE AS CRITICAL COMPONENTS IN LIFE SUPPORT DEVICES OR SYSTEMS WITHOUT THE EXPRESS WRITTEN APPROVAL OF FAIRCHILD SEMICONDUCTOR CORPORATION.

As used herein:

1. Life support devices or systems are devices or systems which, (a) are intended for surgical implant into the body, or (b) support or sustain life, or (c) whose failure to perform when properly used in accordance with instructions for use provided in the labeling, can be reasonably expected to result in significant injury to the user.
2. A critical component is any component of a life support device or system whose failure to perform can be reasonably expected to cause the failure of the life support device or system, or to affect its safety or effectiveness.

PRODUCT STATUS DEFINITIONS

Definition of Terms

Datasheet Identification	Product Status	Definition
Advance Information	Formative or In Design	This datasheet contains the design specifications for product development. Specifications may change in any manner without notice.
Preliminary	First Production	This datasheet contains preliminary data, and supplementary data will be published at a later date. Fairchild Semiconductor reserves the right to make changes at any time without notice to improve design.
No Identification Needed	Full Production	This datasheet contains final specifications. Fairchild Semiconductor reserves the right to make changes at any time without notice to improve design.
Obsolete	Not In Production	This datasheet contains specifications on a product that has been discontinued by Fairchild semiconductor. The datasheet is printed for reference information only.

Rev. I22