

FAN5343

6-LED Series Boost LED Driver with Integrated Schottky Diode and Single-Wire Digital Interface

Features

- Asynchronous Boost Converter
 - V_{OUT} up to 24V
- Internal Schottky Diode
- Up to 500mW Output Power
- 2.7V to 5.5V Input Voltage Range
- Single-Wire Digital Control Interface to Set LED Brightness Levels
 - 32 Linear Steps
- Fixed Switching Frequency: 1.2MHz
- Soft-Start Capability
- Input Under-Voltage Lockout (UVLO)
- Output Over-Voltage Protection (OVP)
- Short-Circuit Detection
- Thermal Shutdown Protection (TSD)
- Small 6-Lead 2.0 x 2.0 x 0.55mm UMLP Package

Applications

- Cellular Mobile Handsets
- Mobile Internet Devices
- Portable Media Players
- PDA, DSC, MP3 Players

Description

The FAN5343 is an asynchronous constant-current LED driver capable of efficiently delivering up to 500mW to a string of six (6) LEDs in series. Optimized for small form factor applications, the 1.2MHz fixed switching frequency allows the use of small chip inductors and capacitors.

The FAN5343 uses a single-wire digital control interface to program the brightness levels of the LEDs in 32 linear steps by applying digital pulses.

For safety, the device features integrated over-voltage, over-current, short circuit detection, and thermal shutdown protection. In addition, input under-voltage lockout protection is triggered if the battery voltage is too low.

The FAN5343 is available in a very low profile, small form factor 2mm x 2mm x 0.55mm 6-lead UMLP package that is green and RoHS compliant.

Ordering Information

Part Number	Temperature Range	Package	Packing
FAN5343UMPX	-40 to 85 °C	6-Lead, Ultra-Thin Molded Leadless (UMLP) Package	Tape and Reel

Typical Application Diagram

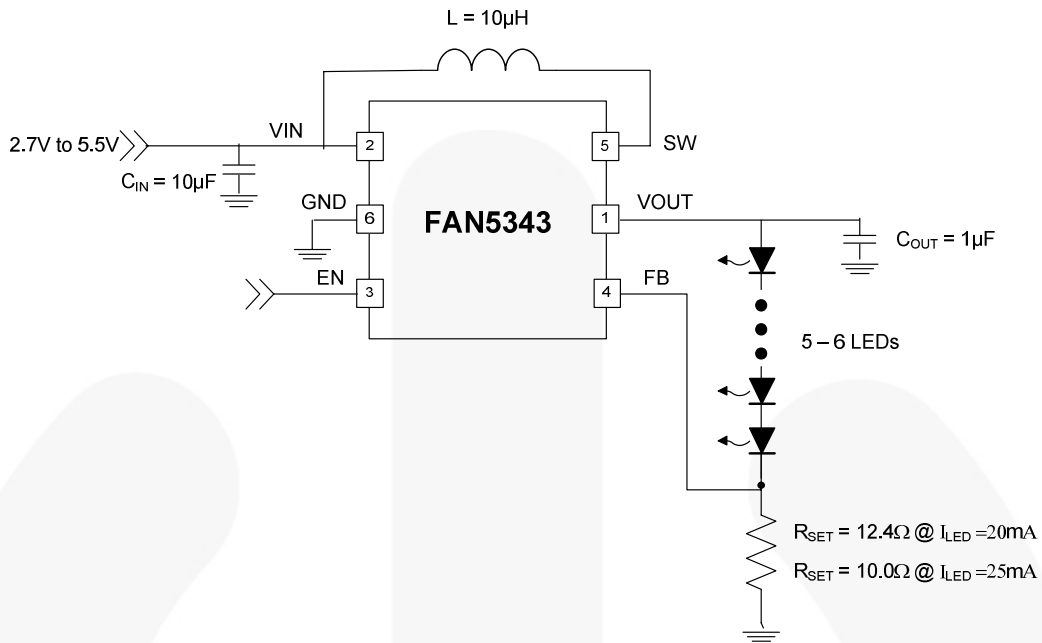

Figure 1. Typical Application

Block Diagram

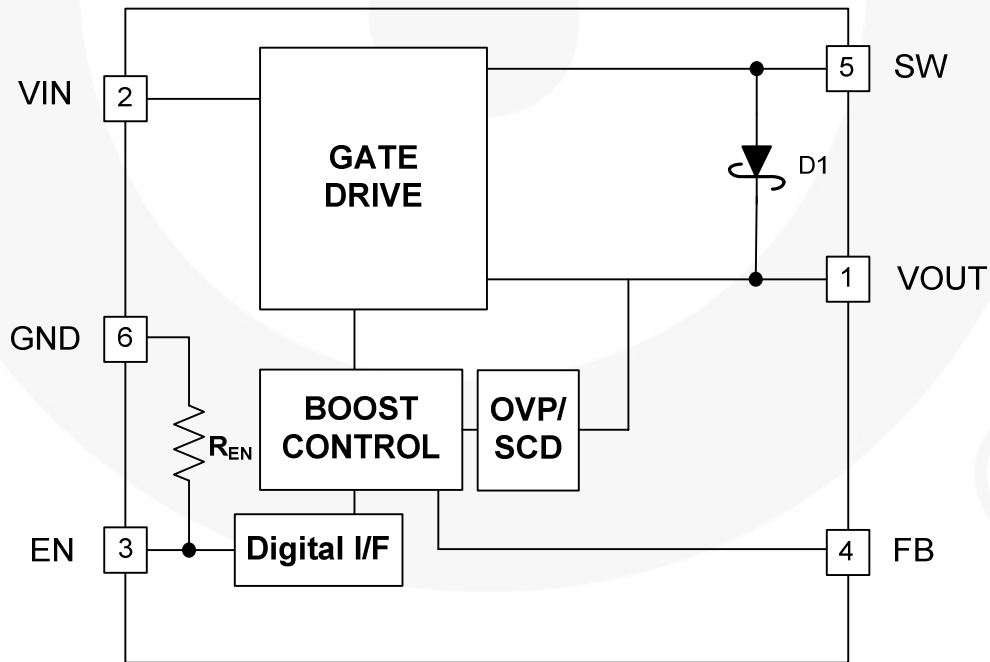

Figure 2. Block Diagram

Pin Configuration

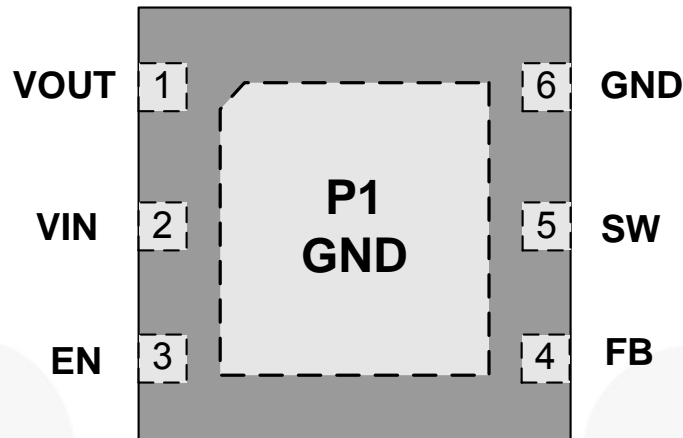

Figure 3. UMLP6 Package (Top View)

Pin Definitions

Pin #	Name	Description
1	VOUT	Boost Output Voltage. Output of the boost regulator. Connect the LEDs to this pin. Connect C_{OUT} to GND.
2	VIN	Input Voltage. Connect to power source and decouple with C_{IN} to GND.
3	EN	Enable Brightness Control. Program dimming levels by driving this pin with digital pulses.
4	FB	Voltage Feedback. The boost regulator regulates this pin to 0.25V to control the LED string current. Tie this pin to a current setting resistor (R_{SET}) between GND and the cathode of the LED string.
5	SW	Switching Node. Tie inductor L1 from the VIN to SW pin.
6	GND	Ground. Tie directly to a GND plane.

Absolute Maximum Ratings

Stresses exceeding the absolute maximum ratings may damage the device. The device may not function or be operable above the recommended operating conditions and stressing the parts to these levels is not recommended. In addition, extended exposure to stresses above the recommended operating conditions may affect device reliability. The absolute maximum ratings are stress ratings only.

Symbol	Parameter	Min.	Max.	Units
V_{IN}	Voltage on VIN Pin	-0.3	6.0	V
V_{FB}, V_{EN}	Voltage on FB and EN Pins	-0.3	$V_{IN} + 0.3$	V
V_{SW}	Voltage on SW Pin	-0.3	25	V
V_{OUT}	Voltage on VOUT Pin	-0.3	25	V
ESD	Electrostatic Discharge Protection Level	Human Body Model per JESD22-A114	3.3	kV
		Charged Device Model per JESD22-C101	2.0	
T_J	Junction Temperature	-40	+150	°C
T_{STG}	Storage Temperature	-65	+150	°C
T_L	Lead Soldering Temperature, 10 Seconds		+260	°C

Recommended Operating Conditions

The Recommended Operating Conditions table defines the conditions for actual device operation. Recommended operating conditions are specified to ensure optimal performance to the datasheet specifications. Fairchild does not recommend exceeding them or designing to absolute maximum ratings.

Symbol	Parameter	Conditions	Min.	Max.	Units
V_{IN}	V_{IN} Supply Voltage		2.7	5.5	V
V_{OUT}	V_{OUT} Voltage ⁽¹⁾		6.2	24.0	V
I_{OUT}	V_{OUT} Load Current	500mW Maximum Output Power	5	25	mA
T_A	Ambient Temperature		-40	+85	°C
T_J	Junction Temperature		-40	+125	°C

Note:

- Application should guarantee that minimum and maximum duty-cycle should fall between 20-85% to meet the specified range.

Thermal Properties

Junction-to-ambient thermal resistance is a function of application and board layout. This data is measured with four-layer 2s2p boards in accordance to JEDEC standard JESD51. Special attention must be paid not to exceed junction temperature $T_{J(max)}$ at a given ambient temperature T_A .

Symbol	Parameter	Typical	Units
θ_{JA}	Junction-to-Ambient Thermal Resistance	70	°C/W

Electrical Specifications

$V_{IN} = 2.7V$ to $5.5V$ and $T_A = -40^{\circ}C$ to $+85^{\circ}C$ unless otherwise noted. Typical values are at $T_A = 25^{\circ}C$ and $V_{IN} = 3.6V$.

Symbol	Parameter	Conditions	Min.	Typ.	Max.	Units
Power Supplies						
I_{SD}	Shutdown Supply Current	EN = GND, $V_{IN} = 3.6V$		0.30	0.75	μA
V_{UVLO}	Under-Voltage Lockout Threshold	V_{IN} Rising	2.10	2.35	2.60	V
		V_{IN} Falling	1.90	2.15	2.40	V
V_{UVHYST}	Under-Voltage Lockout Hysteresis			250		mV
EN: Enable Pin						
V_{IH}	HIGH-Level Input Voltage		1.2			V
V_{IL}	LOW-Level Input Voltage				0.4	V
R_{EN}	EN Pull-Down Resistance		200	300	400	$k\Omega$
t_{LO}	EN Low Time for Dimming	$V_{IN} = 3.6V$; See Figure 14	0.5		300.0	μs
t_{HI}	Time Delay Between Steps	$V_{IN} = 3.6V$; See Figure 14	0.5			μs
T_{SD}	EN Low, Shutdown Pulse Width	$V_{IN} = 3.6V$; from Falling Edge of EN	1			ms
Feedback and Reference						
V_{FB}	Feedback Voltage	$I_{LED} = 20mA$ from $-40^{\circ}C$ to $+85^{\circ}C$, $2.7V \leq V_{IN} \leq 5.5V$	237	250	263	mV
I_{FB}	Feedback Input Current	$V_{FB} = 250mV$		0.1	1.0	μA
Power Outputs						
$R_{DS(ON)Q1}$	Boost Switch On-Resistance	$V_{IN} = 3.6V$, $I_{SW} = 100mA$		600		$m\Omega$
		$V_{IN} = 2.7V$, $I_{SW} = 100mA$		650		
$I_{SW(OFF)}$	SW Node Leakage ⁽²⁾	EN = 0, $V_{IN} = V_{SW} = V_{OUT} = 5.5V$, $V_{LED} = 0$		0.1	2.0	μA
I_{LIM-PK}	Boost Switch Peak Current Limit	$V_{IN} = 3.6V$		750		mA
Oscillator						
f_{SW}	Boost Regulator Switching Frequency		1.0	1.2	1.4	MHz
Output and Protection						
V_{OVP}	Boost Output Over-Voltage Protection		22.5	24.5		V
	OVP Hysteresis			1.0		
V_{TLSC}	V_{OUT} Short Circuit Detection Threshold	V_{OUT} Falling		$V_{IN} - 1.4$		V
V_{THSC}	V_{OUT} Short Circuit Detection Threshold	V_{OUT} Rising		$V_{IN} - 1.2$		V
D_{MAX}	Maximum Boost Duty Cycle ^(3,4)		85			%
D_{MIN}	Minimum Boost Duty Cycle ^(3,4)				20	%
T_{TSD}	Thermal Shutdown			150		$^{\circ}C$
T_{HYS}	Thermal Shutdown Hysteresis			35		$^{\circ}C$

Notes:

- SW leakage current includes the leakage current of two internal switches; SW to GND and SW to VOUT.
- Not tested in production, but guaranteed by design
- Application should guarantee that minimum and maximum duty cycle fall between 20-85% to meet the specified range.

Typical Characteristics

$V_{IN} = 3.6V$, $T_A = 25^\circ C$, $I_{LED} = 25mA$, $L = 10\mu H$, $C_{OUT} = 1.0\mu F$

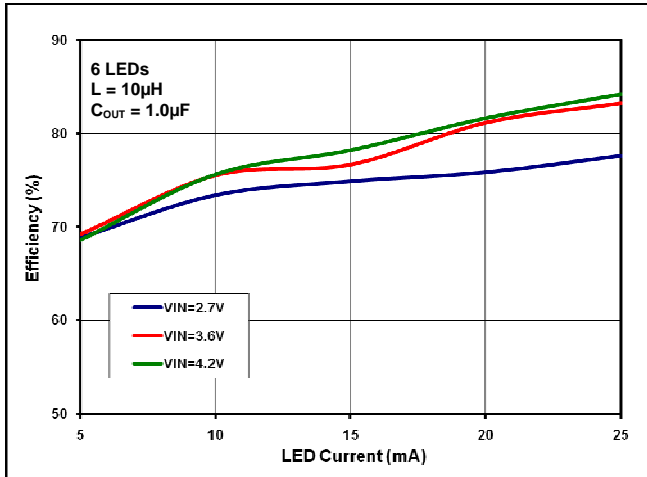

Figure 4. 6 LEDs: Efficiency vs. LED Current vs. Input Voltage

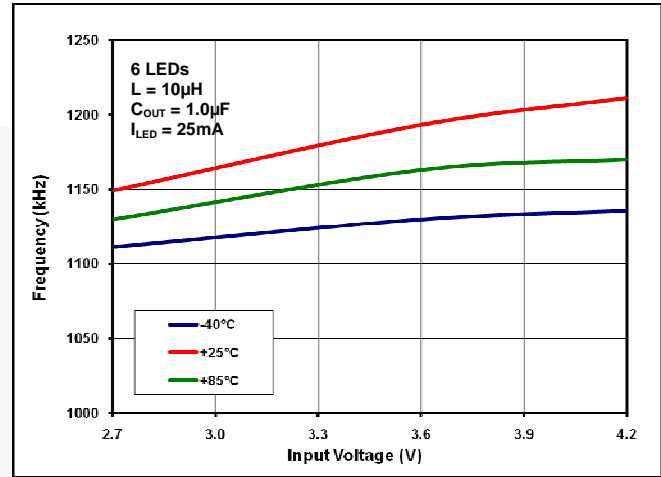

Figure 5. Frequency vs. Input Voltage vs. Temperature

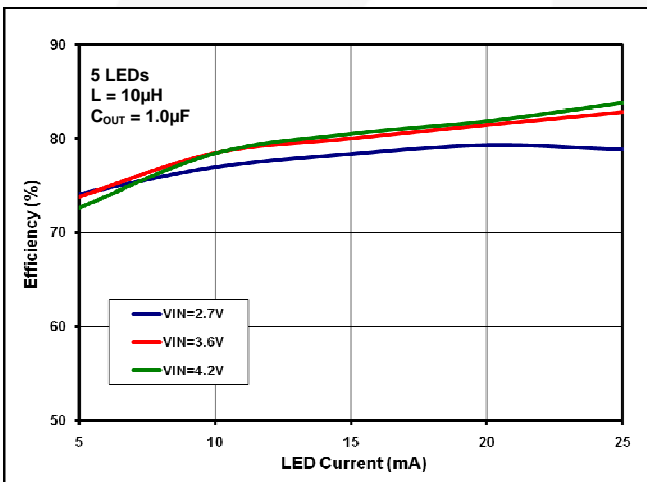

Figure 6. 5 LEDs: Efficiency vs. LED Current vs. Input Voltage

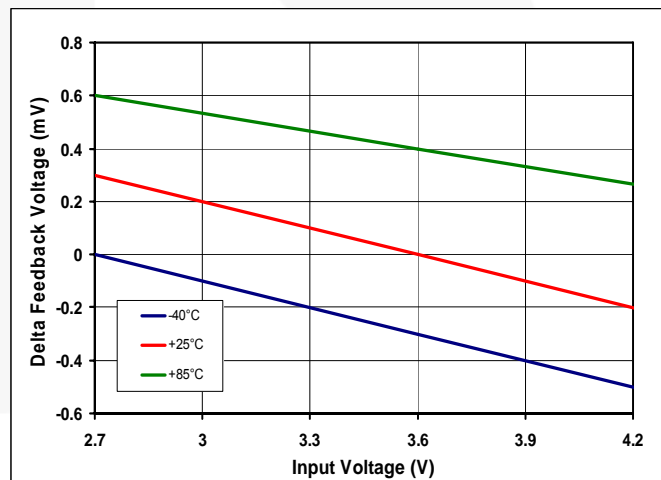

Figure 7. Delta of V_{FB} Over Input Voltage and Temperature for 6 LEDs with $L=10\mu H$ and $C_{OUT}=1.0\mu F$

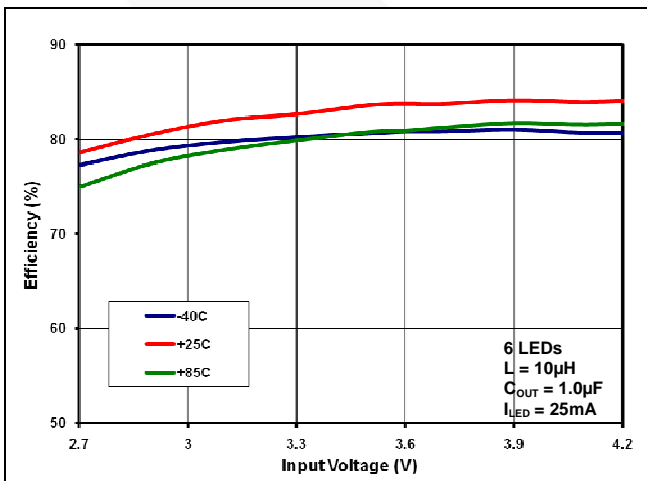

Figure 8. Efficiency vs. Input Voltage vs. Temperature

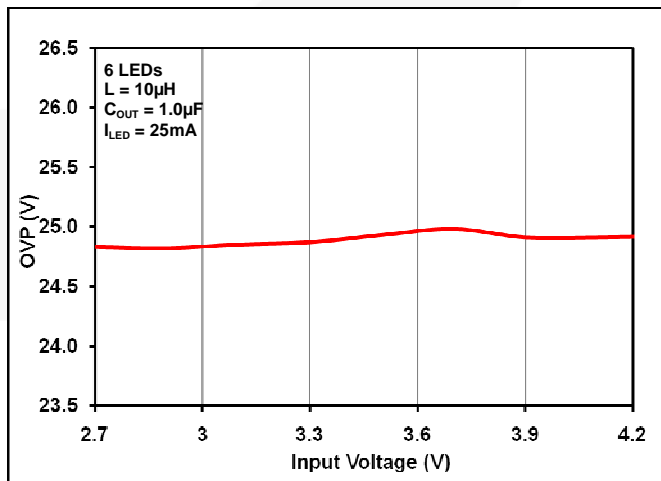

Figure 9. Over-Voltage Protection vs. Input Voltage

Typical Characteristics

$V_{IN} = 3.6V$, $T_A = 25^\circ C$, $I_{LED} = 25mA$, $L = 10\mu H$, $C_{OUT} = 1.0\mu F$

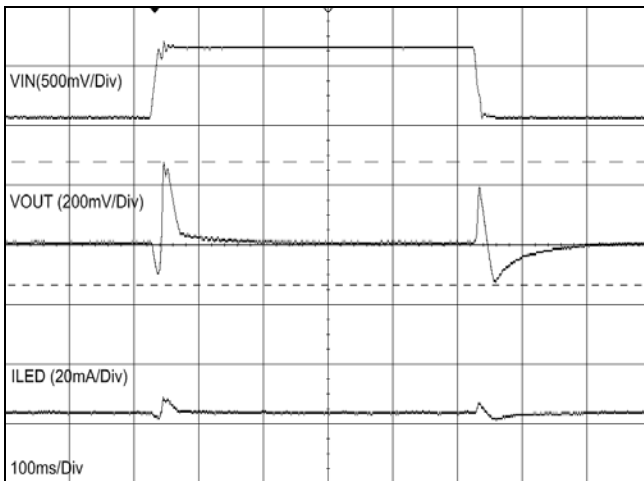

Figure 10. Line Transient Response for 6 LEDs

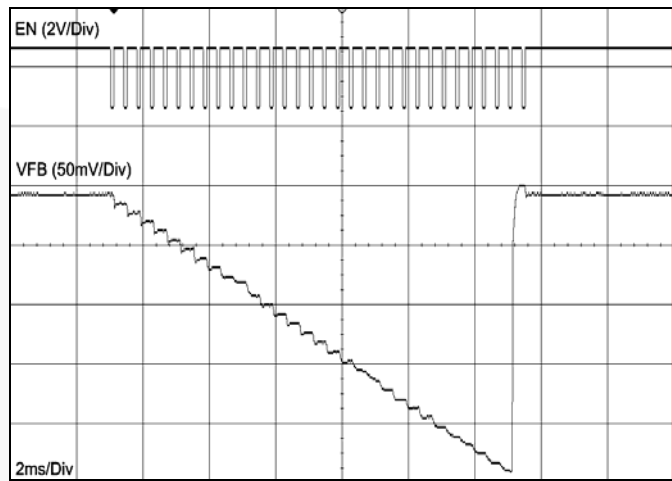

Figure 11. Dimming Operation of FAN5343

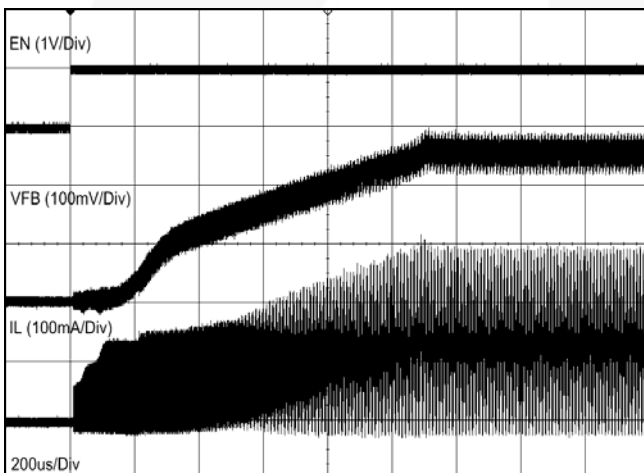

Figure 12. Startup Waveform for Switch Voltage, Inductor Current, V_{FB} , and EN for 6 LEDs

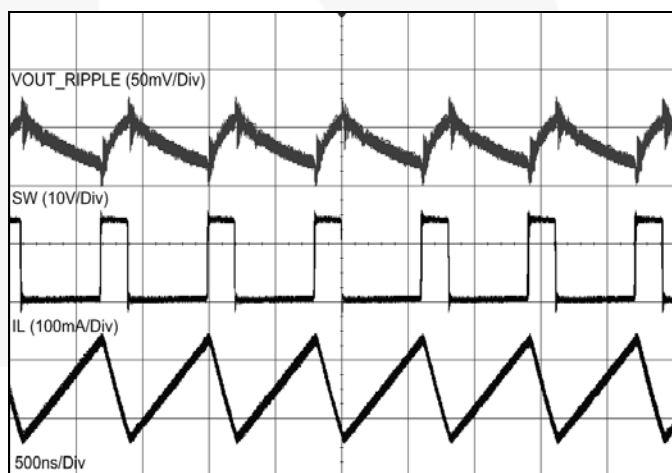

Figure 13. Steady-State Waveform for V_{OUT} , Switch Voltage, and Inductor Current for 6 LEDs

Functional Description

Overview

The FAN5343 is an inductive current-mode boost serial LED driver that achieves LED current regulation by maintaining 0.25V across the R_{SET} resistor. The current through the LED string (I_{LED}) is therefore given by:

$$I_{LED} = \frac{0.25}{R_{SET}} \quad (1)$$

The voltage V_{OUT} is determined by the the sum of the forward voltages across each LED, plus the voltage across R_{SET} , which is always 250mV.

UVLO and Soft-Start

If EN has been LOW for more than 1ms, the IC may initiate a “cold start” soft-start cycle when EN rises, provided V_{IN} is above the UVLO threshold.

Digital Interface

The FAN5343 implements a single-wire digital interface to program the LED brightness to one of thirty two (32) levels spaced in linear steps. With this single-wire solution, the FAN5343 does not require the system processor to constantly supply a signal to drive the LEDs.

Digital Dimming Control

The FAN5343 starts driving the LEDs at the maximum brightness level. After startup, the control logic is ready to accept programming pulses to decrease the brightness level by the positive edges applied to the EN pin. Figure 14 illustrates the digital pulse dimming control for the FAN5343.

Over-Current and Short-Circuit Detection

The boost regulator employs a cycle-by-cycle peak inductor current limit of ~750mA to protect the switching elements and the device itself from being damaged.

Over-Voltage / Open-Circuit Protection

If the LED string is open circuit, FB remains at 0V and the output voltage continues to increase in the absence of an Over-Voltage Protection (OVP) circuit. The FAN5343's OVP circuit disables the boost regulator when V_{OUT} exceeds 24.5V and keeps the regulator off until V_{OUT} drops below 22.5V.

Thermal Shutdown

When the die temperature exceeds 150°C, a reset occurs and remains in effect until the die cools to 125°C; at which time, the circuit is allowed to begin the soft-start sequence.

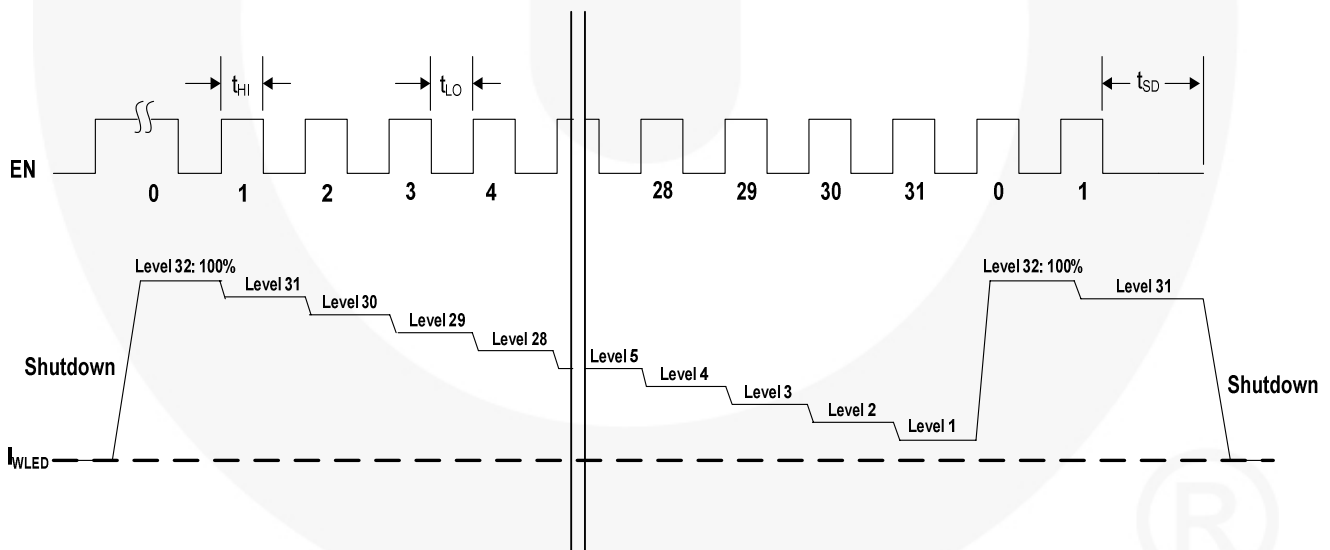

Figure 14. Digital Pulse-Dimming Control Diagram

Application Information

Inductor and Output Capacitor Selection

Table 1. Recommended External Components

# of LEDs	L	Part Number	Manufacturer	Min. C _{OUT}	Part Number	Manufacturer
5, 6	10.0μH	LQH43MN100K03	Murata	1.00μF	UMK212BJ105KG	Taiyo Yuden
		NLCV32T-100K-PFR	TDK			
		VLF3010AT-100MR49-1	TDK			

Component Placement and PCB Recommendations

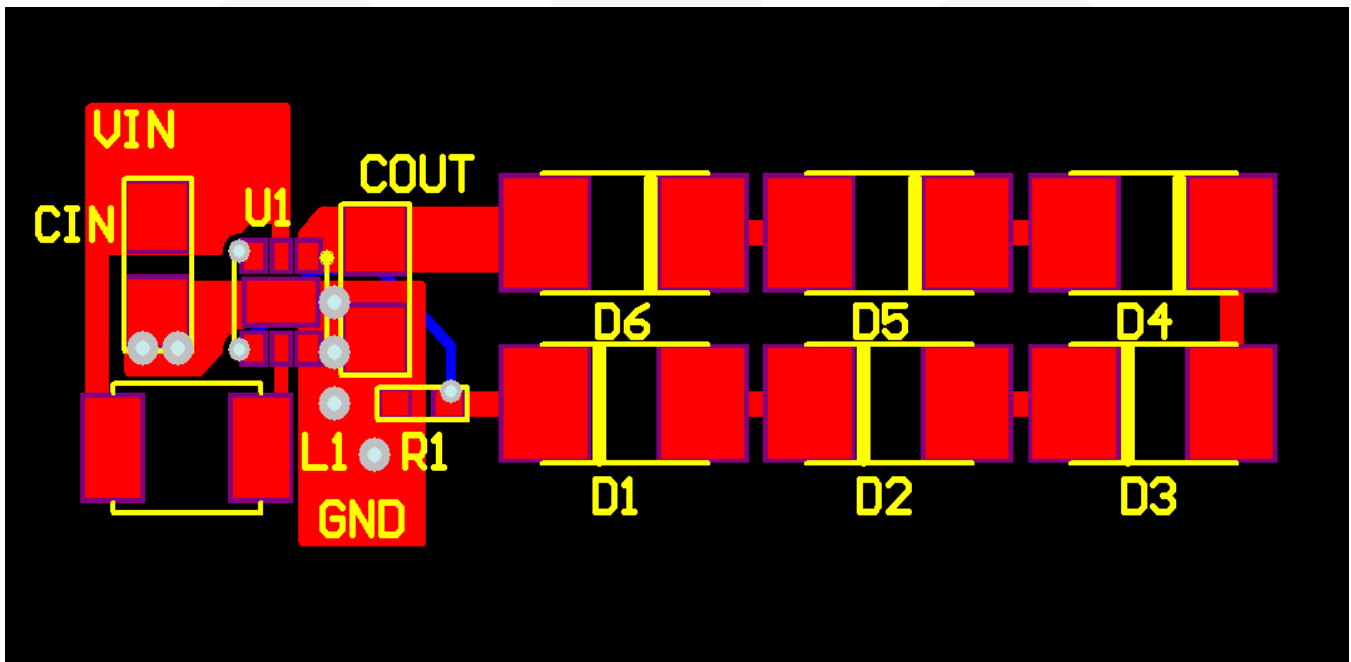

Figure 15. Recommended Component Placement

Input Capacitance

In a typical application, the input and output capacitors should be placed as close to the IC as possible; no additional capacitance is needed to ensure proper functionality. However, in a testing environment, where the FAN5343 is typically powered by a power supply with relatively long cables, an additional input capacitor (10μF) may be needed to ensure stable functioning. This capacitor should be placed close to where the power supply cables attach to the FAN5343 evaluation board.

PCB Recommendations

- The inductor can be connected to VIN with vias through another layer if needed.
- The feedback pin should be connected back to the IC on a sub-layer.

Physical Dimensions

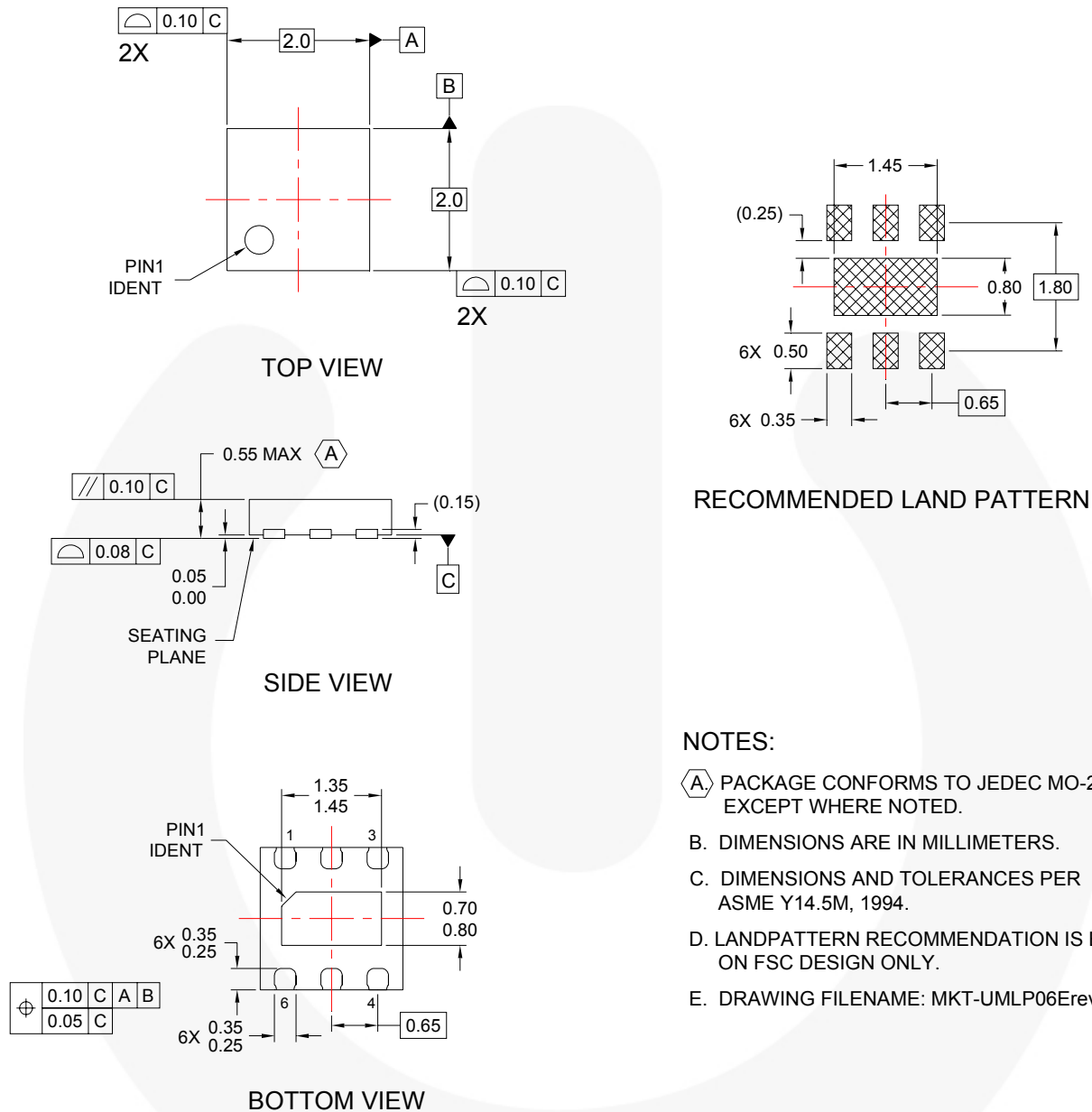

Figure 16. 6-Lead, Ultra-Thin Molded Leadless Package (UMLP)

Package drawings are provided as a service to customers considering Fairchild components. Drawings may change in any manner without notice. Please note the revision and/or date on the drawing and contact a Fairchild Semiconductor representative to verify or obtain the most recent revision. Package specifications do not expand the terms of Fairchild's worldwide terms and conditions, specifically the warranty therein, which covers Fairchild products.

Always visit Fairchild Semiconductor's online packaging area for the most recent package drawings:
<http://www.fairchildsemi.com/packaging/>.

NOTES:

- A. PACKAGE CONFORMS TO JEDEC MO-229 EXCEPT WHERE NOTED.
- B. DIMENSIONS ARE IN MILLIMETERS.
- C. DIMENSIONS AND TOLERANCES PER ASME Y14.5M, 1994.
- D. LANDPATTERN RECOMMENDATION IS BASED ON FSC DESIGN ONLY.
- E. DRAWING FILENAME: MKT-UMLP06Erev2.



TRADEMARKS

The following includes registered and unregistered trademarks and service marks, owned by Fairchild Semiconductor and/or its global subsidiaries, and is not intended to be an exhaustive list of all such trademarks.

- | | | | |
|--------------------------|------------------------|---------------------------------------|---|
| AccuPower™ | F-PFS™ | Power-SPM™ | <p>SYSTEM GENERAL®
The Power Franchise®</p> <p>power franchise™</p> |
| Auto-SPM™ | FRFET® | PowerTrench® | |
| Build it Now™ | Global Power Resource™ | PowerXS™ | |
| CorePLUS™ | Green FPS™ | Programmable Active Droop™ | |
| CorePOWER™ | Green FPS™ e-Series™ | QFET® | |
| CROSSVOLT™ | Gmax™ | QST™ | |
| CTL™ | GTO™ | Quiet Series™ | |
| Current Transfer Logic™ | IntelliMAX™ | RapidConfigure™ | |
| DEUXPEED® | ISOPLANAR™ | Saving our world, 1mW/W/kW at a time™ | |
| Dual Cool™ | MegaBuck™ | SignalWise™ | |
| EcoSPARK® | MICROCOUPLER™ | SmartMax™ | |
| EfficientMax™ | MicroFET™ | SMART START™ | |
| ESBCT™ | MicroPak™ | SPM® | |
| Fairchild® | MicroPak2™ | STEALTH™ | |
| Fairchild Semiconductor® | MillerDrive™ | SuperFET™ | |
| FACT Quiet Series™ | MotionMax™ | SuperSOT™.3 | |
| FACT® | Motion-SPM™ | SuperSOT™.6 | |
| FAST® | OptoHIT™ | SuperSOT™.8 | |
| FAST® | OPTOLOGIC® | SupreMOS® | |
| FastvCore™ | OPTOPLANAR® | SyncFET™ | |
| FETBench™ | PDP-SPM™ | Sync-Lock™ | |
| FlashWriter® | | | <p>SerDes™</p> |
| FPS™ | | | UHC® |
| | | | Ultra FRFET™ |
| | | | UniFET™ |
| | | | VCC™ |
| | | | VisualMax™ |
| | | | XST™ |

* Trademarks of System General Corporation, used under license by Fairchild Semiconductor.

DISCLAIMER

FAIRCHILD SEMICONDUCTOR RESERVES THE RIGHT TO MAKE CHANGES WITHOUT FURTHER NOTICE TO ANY PRODUCTS HEREIN TO IMPROVE RELIABILITY, FUNCTION, OR DESIGN. FAIRCHILD DOES NOT ASSUME ANY LIABILITY ARISING OUT OF THE APPLICATION OR USE OF ANY PRODUCT OR CIRCUIT DESCRIBED HEREIN; NEITHER DOES IT CONVEY ANY LICENSE UNDER ITS PATENT RIGHTS, NOR THE RIGHTS OF OTHERS. THESE SPECIFICATIONS DO NOT EXPAND THE TERMS OF FAIRCHILD'S WORLDWIDE TERMS AND CONDITIONS, SPECIFICALLY THE WARRANTY THEREIN, WHICH COVERS THESE PRODUCTS.

LIFE SUPPORT POLICY

FAIRCHILD'S PRODUCTS ARE NOT AUTHORIZED FOR USE AS CRITICAL COMPONENTS IN LIFE SUPPORT DEVICES OR SYSTEMS WITHOUT THE EXPRESS WRITTEN APPROVAL OF FAIRCHILD SEMICONDUCTOR CORPORATION.

As used herein:

1. Life support devices or systems are devices or systems which, (a) are intended for surgical implant into the body or (b) support or sustain life, and (c) whose failure to perform when properly used in accordance with instructions for use provided in the labeling, can be reasonably expected to result in a significant injury of the user.
2. A critical component in any component of a life support, device, or system whose failure to perform can be reasonably expected to cause the failure of the life support device or system, or to affect its safety or effectiveness.

ANTI-COUNTERFEITING POLICY

Fairchild Semiconductor Corporation's Anti-Counterfeiting Policy. Fairchild's Anti-Counterfeiting Policy is also stated on our external website, www.fairchildsemi.com, under Sales Support.

Counterfeiting of semiconductor parts is a growing problem in the industry. All manufacturers of semiconductor products are experiencing counterfeiting of their parts. Customers who inadvertently purchase counterfeit parts experience many problems such as loss of brand reputation, substandard performance, failed applications, and increased cost of production and manufacturing delays. Fairchild is taking strong measures to protect ourselves and our customers from the proliferation of counterfeit parts. Fairchild strongly encourages customers to purchase Fairchild parts either directly from Fairchild or from Authorized Fairchild Distributors who are listed by country on our web page cited above. Products customers buy either from Fairchild directly or from Authorized Fairchild Distributors are genuine parts, have full traceability, meet Fairchild's quality standards for handling and storage and provide access to Fairchild's full range of up-to-date technical and product information. Fairchild and our Authorized Distributors will stand behind all warranties and will appropriately address any warranty issues that may arise. Fairchild will not provide any warranty coverage or other assistance for parts bought from Unauthorized Sources. Fairchild is committed to combat this global problem and encourage our customers to do their part in stopping this practice by buying direct or from authorized distributors.

PRODUCT STATUS DEFINITIONS

Definition of Terms

Datasheet Identification	Product Status	Definition
Advance Information	Formative / In Design	Datasheet contains the design specifications for product development. Specifications may change in any manner without notice.
Preliminary	First Production	Datasheet contains preliminary data; supplementary data will be published at a later date. Fairchild Semiconductor reserves the right to make changes at any time without notice to improve design.
No Identification Needed	Full Production	Datasheet contains final specifications. Fairchild Semiconductor reserves the right to make changes at any time without notice to improve the design.
Obsolete	Not In Production	Datasheet contains specifications on a product that is discontinued by Fairchild Semiconductor. The datasheet is for reference information only.

Rev. I49