



July 2014

FDFMA3P029Z

Integrated P-Channel PowerTrench[®] MOSFET and Schottky Diode

-30 V, -3.3 A, 87 mΩ

Features

MOSFET

- Max $r_{DS(on)}$ = 87 mΩ at $V_{GS} = -10$ V, $I_D = -3.3$ A
- Max $r_{DS(on)}$ = 152 mΩ at $V_{GS} = -4.5$ V, $I_D = -2.3$ A
- HBM ESD protection level > 2 KV typical (Note 3)

Schottky

- $V_F < 0.37$ V @ 500 mA
- Low profile - 0.8 mm maximum - in the new package MicroFET 2x2 mm
- RoHS Compliant

General Description

This device is designed specifically as a single package solution for the battery charge switch in cellular handset and other ultra-portable applications. It features a MOSFET with very low on-state resistance and an independently connected low forward voltage schottky diode allows for minimum conduction losses.

The MicroFET 2X2 package offers exceptional thermal performance for its physical size and is well suited to linear mode applications.

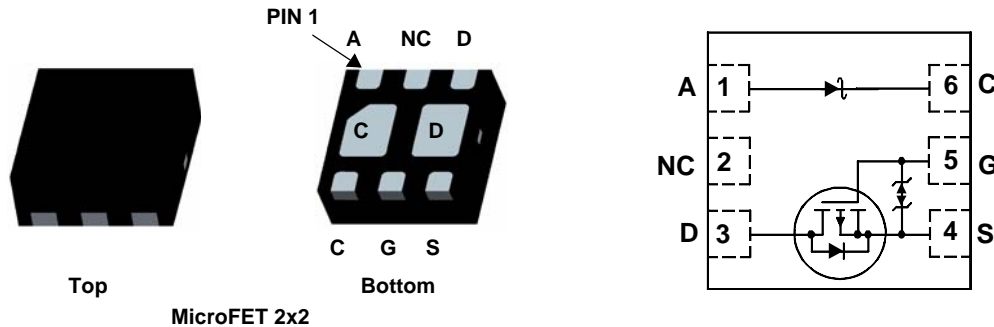

MOSFET Maximum Ratings $T_A = 25$ °C unless otherwise noted

| Symbol | Parameter | Ratings | Units |
|----------------|--|-------------|-------|
| V_{DS} | Drain to Source Voltage | -30 | V |
| V_{GS} | Gate to Source Voltage | ±25 | V |
| I_D | Drain Current -Continuous (Note 1a) | -3.3 | A |
| | -Pulsed | -15 | |
| P_D | Power Dissipation (Note 1a) | 1.4 | W |
| | | (Note 1b) | |
| T_J, T_{STG} | Operating and Storage Junction Temperature Range | -55 to +150 | °C |
| V_{RRM} | Schottky Repetitive Peak Reverse Voltage | 20 | V |
| I_O | Schottky Average Forward Current | 2 | A |

Thermal Characteristics

| | | | |
|-----------------|---|-----|------|
| $R_{\theta JA}$ | Thermal Resistance, Junction to Ambient (Note 1a) | 86 | °C/W |
| $R_{\theta JA}$ | Thermal Resistance, Junction to Ambient (Note 1b) | 173 | |
| $R_{\theta JA}$ | Thermal Resistance, Junction to Ambient (Note 1c) | 86 | |
| $R_{\theta JA}$ | Thermal Resistance, Junction to Ambient (Note 1d) | 173 | |

Package Marking and Ordering Information

| Device Marking | Device | Package | Reel Size | Tape Width | Quantity |
|----------------|-------------|--------------|-----------|------------|------------|
| 3P2 | FDFMA3P029Z | MicroFET 2X2 | 7" | 8 mm | 3000 units |

FDFMA3P029Z Integrated P-Channel PowerTrench[®] MOSFET and Schottky Diode

Electrical Characteristics $T_J = 25\text{ }^\circ\text{C}$ unless otherwise noted

| Symbol | Parameter | Test Conditions | Min | Typ | Max | Units |
|--------|-----------|-----------------|-----|-----|-----|-------|
|--------|-----------|-----------------|-----|-----|-----|-------|

Off Characteristics

| | | | | | | |
|--------------------------------------|---|--|-----|-----|----------|----------------------|
| BV_{DSS} | Drain to Source Breakdown Voltage | $I_D = -250\ \mu\text{A}, V_{GS} = 0\ \text{V}$ | -30 | | | V |
| $\frac{\Delta BV_{DSS}}{\Delta T_J}$ | Breakdown Voltage Temperature Coefficient | $I_D = -250\ \mu\text{A}$, referenced to $25\text{ }^\circ\text{C}$ | | -22 | | mV/ $^\circ\text{C}$ |
| I_{DSS} | Zero Gate Voltage Drain Current | $V_{DS} = -24\ \text{V}, V_{GS} = 0\ \text{V}$ | | | -1 | μA |
| I_{GSS} | Gate to Source Leakage Current | $V_{GS} = \pm 25\ \text{V}, V_{DS} = 0\ \text{V}$ | | | ± 10 | μA |

On Characteristics

| | | | | | | |
|--|--|---|------|------|------|----------------------|
| $V_{GS(th)}$ | Gate to Source Threshold Voltage | $V_{GS} = V_{DS}, I_D = -250\ \mu\text{A}$ | -1.3 | -1.9 | -2.3 | V |
| $\frac{\Delta V_{GS(th)}}{\Delta T_J}$ | Gate to Source Threshold Voltage Temperature Coefficient | $I_D = -250\ \mu\text{A}$, referenced to $25\text{ }^\circ\text{C}$ | | 5 | | mV/ $^\circ\text{C}$ |
| $r_{DS(on)}$ | Static Drain to Source On-Resistance | $V_{GS} = -10\ \text{V}, I_D = -3.3\ \text{A}$ | | 69 | 87 | m Ω |
| | | $V_{GS} = -4.5\ \text{V}, I_D = -2.3\ \text{A}$ | | 108 | 152 | |
| | | $V_{GS} = -10\ \text{V}, I_D = -3.3\ \text{A}, T_J = 125\text{ }^\circ\text{C}$ | | 97 | 122 | |
| g_{FS} | Forward Transconductance | $V_{DS} = -5\ \text{V}, I_D = -3.3\ \text{A}$ | | 6 | | S |
| R_g | Gate Resistance | | | 12 | | Ω |

Dynamic Characteristics

| | | | | | | |
|-----------|------------------------------|---|--|-----|-----|----|
| C_{iss} | Input Capacitance | $V_{DS} = -15\ \text{V}, V_{GS} = 0\ \text{V}, f = 1\ \text{MHz}$ | | 324 | 435 | pF |
| C_{oss} | Output Capacitance | | | 59 | 80 | pF |
| C_{rss} | Reverse Transfer Capacitance | | | 53 | 80 | pF |

Switching Characteristics

| | | | | | | |
|--------------|-------------------------------|---|--|-----|----|----|
| $t_{d(on)}$ | Turn-On Delay Time | $V_{DD} = -15\ \text{V}, I_D = -3.3\ \text{A}, V_{GS} = -10\ \text{V}, R_{GEN} = 6\ \Omega$ | | 5.2 | 11 | ns |
| t_r | Rise Time | | | 3 | 10 | ns |
| $t_{d(off)}$ | Turn-Off Delay Time | | | 17 | 31 | ns |
| t_f | Fall Time | | | 11 | 25 | ns |
| $Q_{g(TOT)}$ | Total Gate Charge | $V_{GS} = 0\ \text{V to } -10\ \text{V}$ | $V_{DD} = -15\ \text{V}, I_D = -3.3\ \text{A}$ | 7.2 | 10 | nC |
| | Total Gate Charge | $V_{GS} = 0\ \text{V to } -5\ \text{V}$ | | 4.1 | 6 | nC |
| Q_{gs} | Gate to Source Gate Charge | | | 1.0 | | nC |
| Q_{gd} | Gate to Drain "Miller" Charge | | | 1.9 | | nC |

Drain-Source Diode Characteristics

| | | | | | | |
|----------|---------------------------------------|---|--|-------|------|----|
| V_{SD} | Source to Drain Diode Forward Voltage | $V_{GS} = 0\ \text{V}, I_S = -3.3\ \text{A}$ (Note 2) | | -0.94 | -1.3 | V |
| t_{rr} | Reverse Recovery Time | $I_F = -3.3\ \text{A}, di/dt = 100\ \text{A}/\mu\text{s}$ | | 20 | 32 | ns |
| Q_{rr} | Reverse Recovery Charge | | | 10 | 18 | nC |

Schottky Diode Characteristics

| | | | | | | | |
|-------|-----------------|------------------------|-----------------------------------|----|------|-------|---------------|
| V_R | Reverse Voltage | $I_R = 1\ \text{mA}$ | $T_J = 25\text{ }^\circ\text{C}$ | 20 | | | V |
| I_R | Reverse Leakage | $V_R = 20\ \text{V}$ | $T_J = 25\text{ }^\circ\text{C}$ | | 30 | 300 | μA |
| | | | $T_J = 125\text{ }^\circ\text{C}$ | | 10 | 45 | mA |
| V_F | Forward Voltage | $I_F = 500\ \text{mA}$ | $T_J = 25\text{ }^\circ\text{C}$ | | 0.32 | 0.37 | V |
| | | | $T_J = 125\text{ }^\circ\text{C}$ | | 0.21 | 0.26 | |
| | | $I_F = 1\ \text{A}$ | $T_J = 25\text{ }^\circ\text{C}$ | | 0.37 | 0.435 | |
| | | | $T_J = 125\text{ }^\circ\text{C}$ | | 0.28 | 0.33 | |

Notes:

- 1: $R_{\theta JA}$ is determined with the device mounted on a 1 in² oz. copper pad on a 1.5 x 1.5 in. board of FR-4 material. $R_{\theta JC}$ is guaranteed by design while $R_{\theta JA}$ is determined by the user's board design.
- (a) MOSFET $R_{\theta JA} = 86$ °C/W when mounted on a 1in² pad of 2 oz copper, 1.5" x 1.5" x 0.062" thick PCB
 - (b) MOSFET $R_{\theta JA} = 173$ °C/W when mounted on a minimum pad of 2 oz copper
 - (c) Schottky $R_{\theta JA} = 86$ °C/W when mounted on a 1in² pad of 2 oz copper, 1.5" x 1.5" x 0.062" thick PCB.
 - (d) Schottky $R_{\theta JA} = 173$ °C/W when mounted on a minimum pad of 2 oz copper.

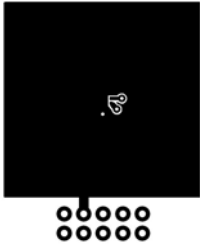

a) 86 °C/W when mounted on a 1in² pad of 2 oz copper.

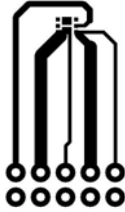

b) 173 °C/W when mounted on a minimum pad of 2 oz copper.



c) 86 °C/W when mounted on a 1in² pad of 2 oz copper.

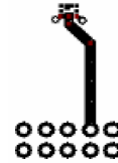

d) 173 °C/W when mounted on a minimum pad of 2 oz copper.

2: Pulse Test : Pulse Width < 300 μs, Duty Cycle < 2.0%

3: The diode connected between the gate and source serves only protection against ESD. No gate overvoltage rating is implied.

Typical Characteristics $T_J = 25\text{ }^\circ\text{C}$ unless otherwise noted

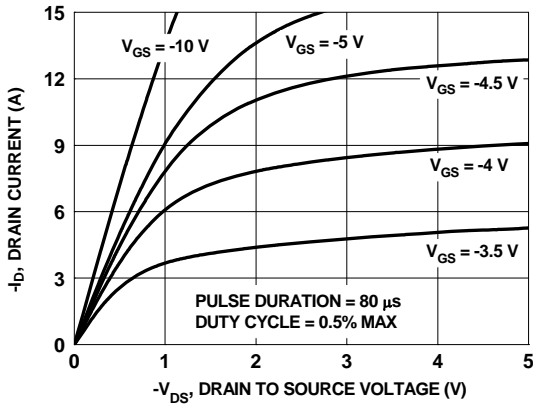

Figure 1. On-Region Characteristics

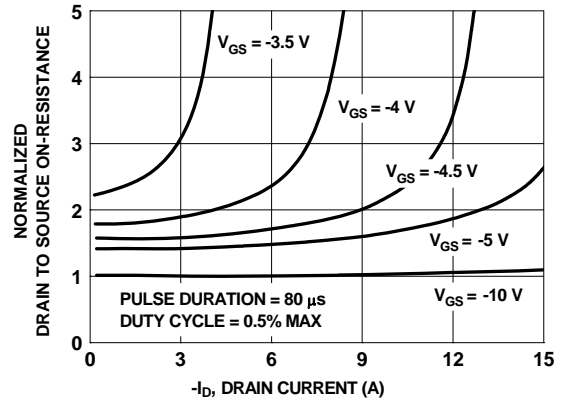

Figure 2. Normalized On-Resistance vs Drain Current and Gate Voltage

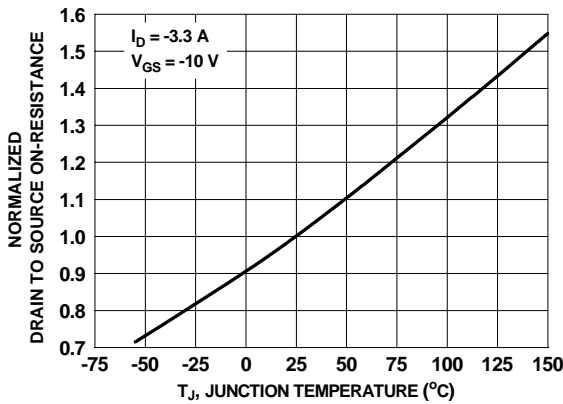

Figure 3. Normalized On-Resistance vs Junction Temperature

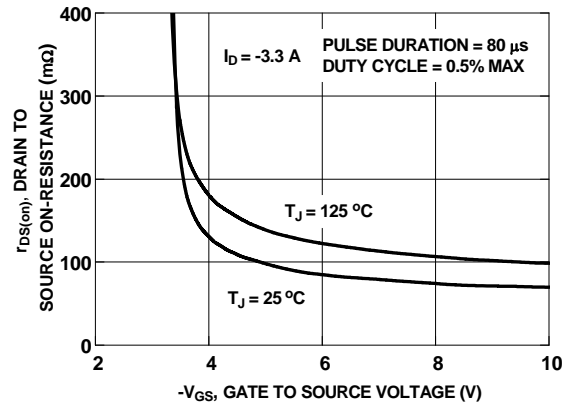

Figure 4. On-Resistance vs Gate to Source Voltage

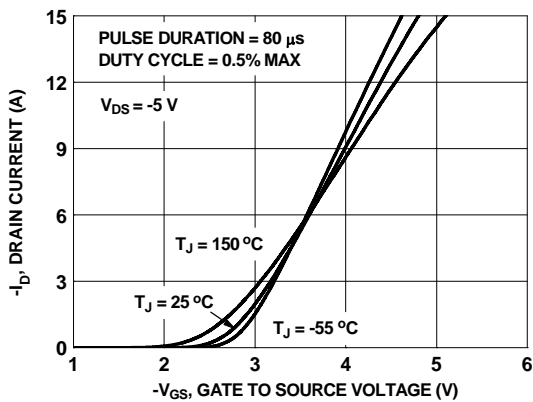

Figure 5. Transfer Characteristics

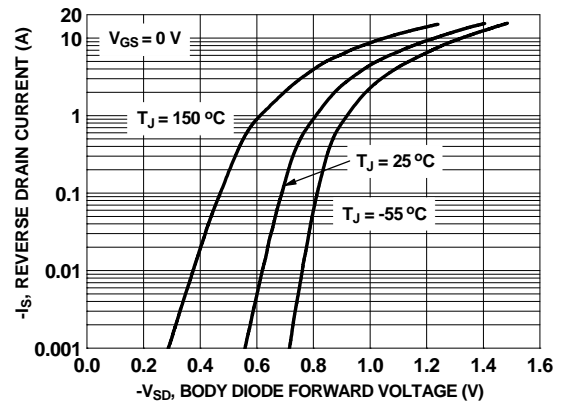

Figure 6. Source to Drain Diode Forward Voltage vs Source Current

Typical Characteristics $T_J = 25\text{ }^\circ\text{C}$ unless otherwise noted

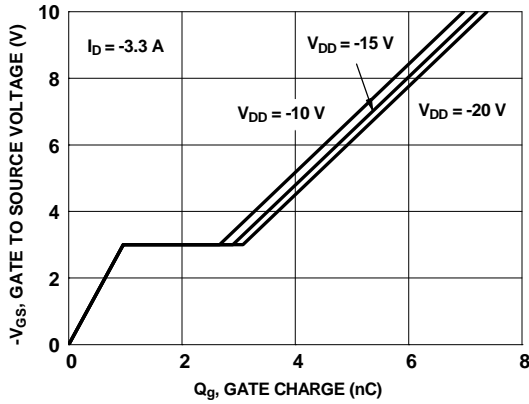

Figure 7. Gate Charge Characteristics

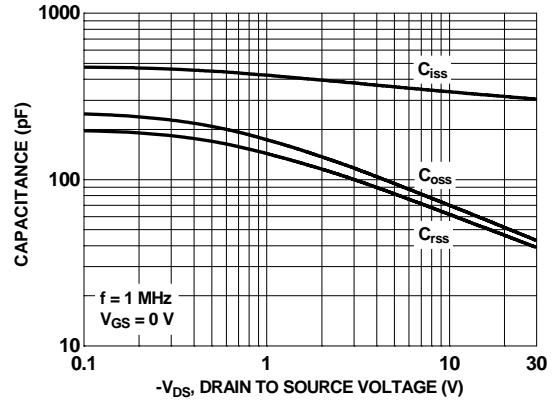

Figure 8. Capacitance vs Drain to Source Voltage

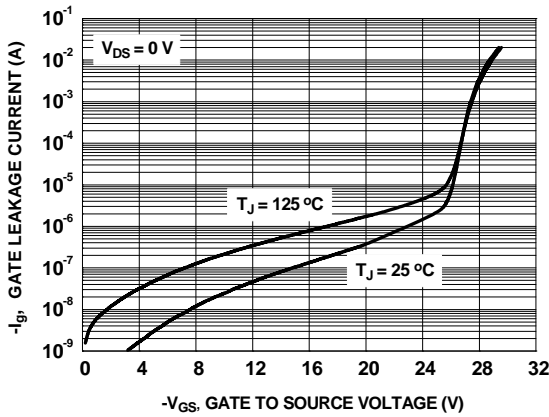

Figure 9. Gate Leakage Current vs Gate to Source Voltage

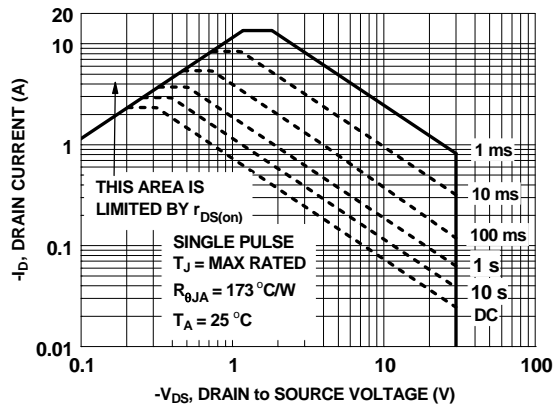

Figure 10. Forward Bias Safe Operating Area

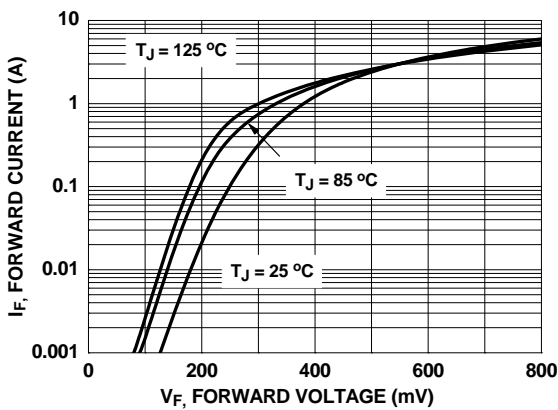

Figure 11. Schottky Diode Forward Voltage

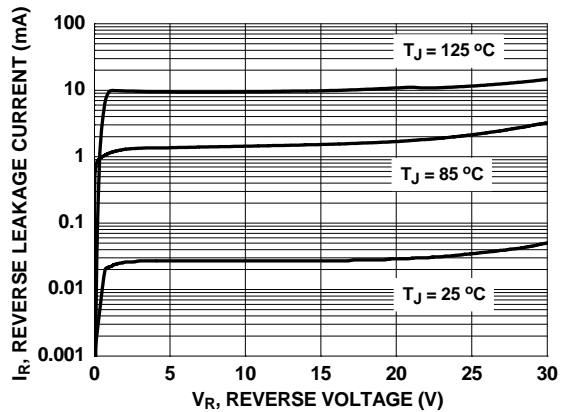

Figure 12. Schottky Diode Reverse Current

Typical Characteristics $T_J = 25\text{ }^\circ\text{C}$ unless otherwise noted

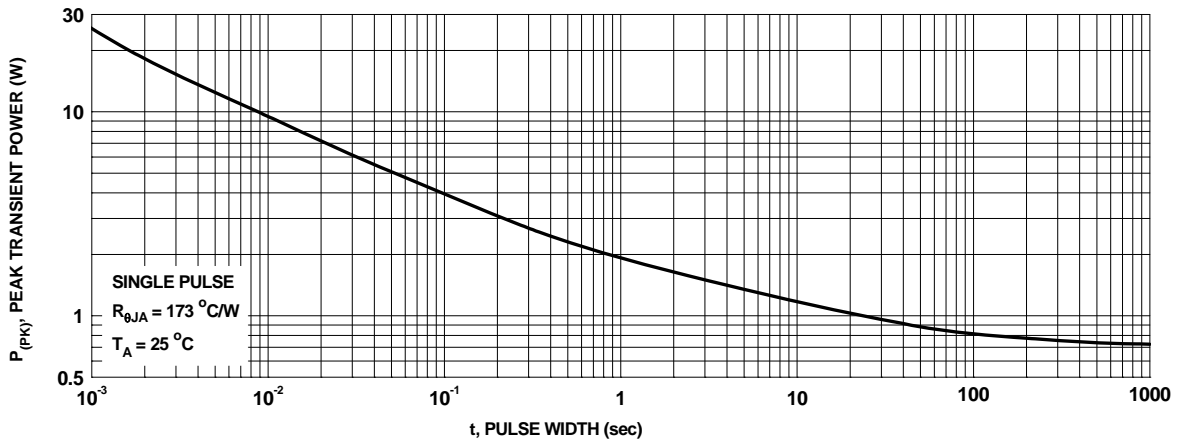

Figure 13. Single Pulse Maximum Power Dissipation

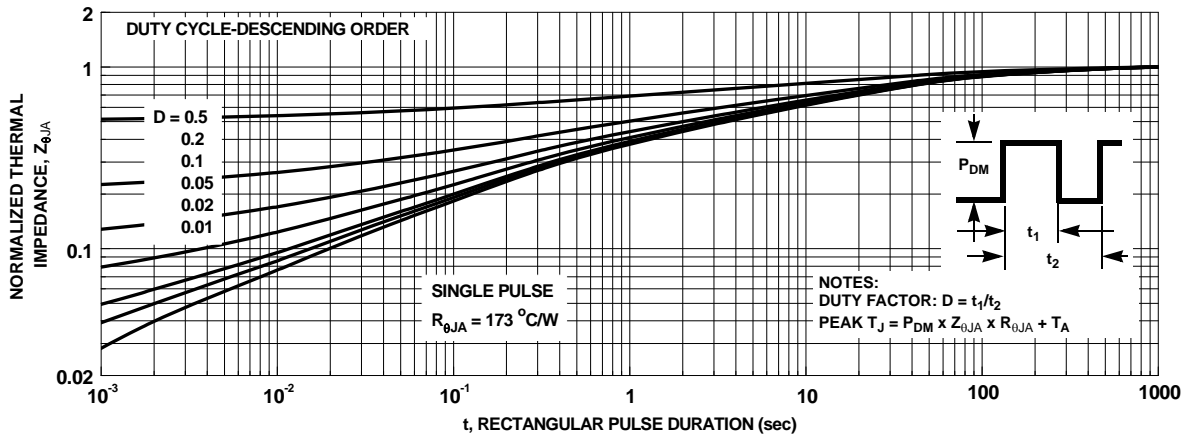
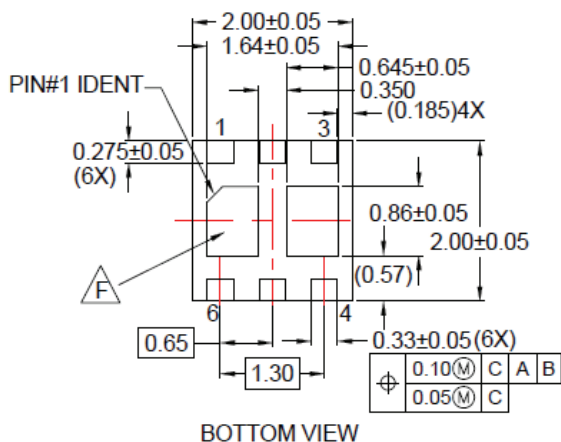
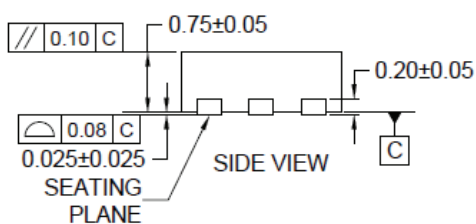
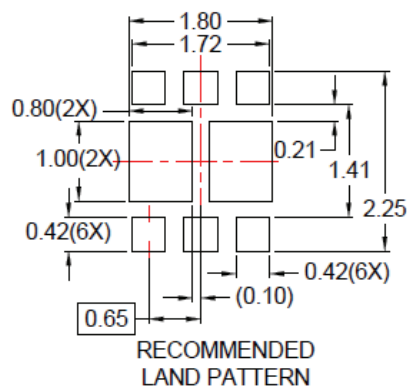
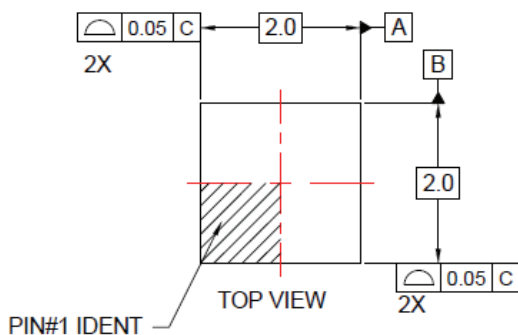

Figure 14. Junction-to-Ambient Transient Thermal Response Curve

Dimensional Outline and Pad Layout



NOTES:

- A. CONFORM TO JADEC REGISTRATIONS MO-229, VARIATION VCCC, EXCEPT WHERE NOTED.
 - B. DIMENSIONS ARE IN MILLIMETERS.
 - C. DIMENSIONS AND TOLERANCES PER ASME Y14.5M, 2009.
 - D. LAND PATTERN RECOMMENDATION IS EXISTING INDUSTRY LAND PATTERN.
 - E. DRAWING FILENAME: MKT-UMLP16Erev4
- NON-JEDEC DUAL DAP



Package drawings are provided as a service to customers considering Fairchild components. Drawings may change in any manner without notice. Please note the revision and/or date on the drawing and contact a Fairchild Semiconductor representative to verify or obtain the most recent revision. Package specifications do not expand the terms of Fairchild's worldwide terms and conditions, specifically the warranty therein, which covers Fairchild products.





Always visit Fairchild Semiconductor's online packaging area for the most recent package drawings:

http://www.fairchildsemi.com/package/packageDetails.html?id=PN_MLDEB-X06



TRADEMARKS

The following includes registered and unregistered trademarks and service marks, owned by Fairchild Semiconductor and/or its global subsidiaries, and is not intended to be an exhaustive list of all such trademarks.

- | | | | |
|---|---|---|---|
| AccuPower™ | F-PFST™ |  |  |
| AX-CAP®* | FRFET® | PowerTrench® | TinyBoost® |
| BitSiC™ | Global Power ResourceSM | PowerXS™ | TinyBuck® |
| Build it Now™ | GreenBridge™ | Programmable Active Droop™ | TinyCalc™ |
| CorePLUS™ | Green FPS™ | QFET® | TinyLogic® |
| CorePOWER™ | Green FPS™ e-Series™ | QS™ | TINYOPTO™ |
| CROSSVOL™ | Gmax™ | Quiet Series™ | TinyPower™ |
| CTL™ | GTO™ | RapidConfigure™ | TinyPWM™ |
| Current Transfer Logic™ | IntelliMAX™ |  | TinyWire™ |
| DEUXPEED® | ISOPLANAR™ | Saving our world, 1mW/W/kW at a time™ | TranSiC™ |
| Dual Cool™ | Marking Small Speakers Sound Louder and Better™ | SignalWise™ | TriFault Detect™ |
| EcoSPARK® | MegaBuck™ | SmartMax™ | TRUECURRENT®* |
| EfficientMax™ | MICROCOUPLER™ | SMART START™ | µSerDes™ |
| ESBC™ | MicroFET™ | Solutions for Your Success™ |  |
|  | MicroPak™ | SPM® | UHC® |
| Fairchild® | MicroPak2™ | STEALTH™ | Ultra FRFET™ |
| Fairchild Semiconductor® | MillerDrive™ | SuperFET® | UniFET™ |
| FACT Quiet Series™ | MotionMax™ | SuperSOT™-3 | VCX™ |
| FACT® | mWSaver® | SuperSOT™-6 | VisualMax™ |
| FAST® | OptoHit™ | SuperSOT™-8 | VoltagePlus™ |
| FastvCore™ | OPTOLOGIC® | SupreMOS® | XST™ |
| FETBench™ | OPTOPLANAR® | SyncFET™ | 仙童™ |
| FPS™ | | Sync-Lock™ | |

*Trademarks of System General Corporation, used under license by Fairchild Semiconductor.

DISCLAIMER

FAIRCHILD SEMICONDUCTOR RESERVES THE RIGHT TO MAKE CHANGES WITHOUT FURTHER NOTICE TO ANY PRODUCTS HEREIN TO IMPROVE RELIABILITY, FUNCTION, OR DESIGN. FAIRCHILD DOES NOT ASSUME ANY LIABILITY ARISING OUT OF THE APPLICATION OR USE OF ANY PRODUCT OR CIRCUIT DESCRIBED HEREIN; NEITHER DOES IT CONVEY ANY LICENSE UNDER ITS PATENT RIGHTS, NOR THE RIGHTS OF OTHERS. THESE SPECIFICATIONS DO NOT EXPAND THE TERMS OF FAIRCHILD'S WORLDWIDE TERMS AND CONDITIONS, SPECIFICALLY THE WARRANTY THEREIN, WHICH COVERS THESE PRODUCTS.

LIFE SUPPORT POLICY

FAIRCHILD'S PRODUCTS ARE NOT AUTHORIZED FOR USE AS CRITICAL COMPONENTS IN LIFE SUPPORT DEVICES OR SYSTEMS WITHOUT THE EXPRESS WRITTEN APPROVAL OF FAIRCHILD SEMICONDUCTOR CORPORATION.

As used here in:

- Life support devices or systems are devices or systems which, (a) are intended for surgical implant into the body or (b) support or sustain life, and (c) whose failure to perform when properly used in accordance with instructions for use provided in the labeling, can be reasonably expected to result in a significant injury of the user.
- A critical component in any component of a life support, device, or system whose failure to perform can be reasonably expected to cause the failure of the life support device or system, or to affect its safety or effectiveness.

ANTI-COUNTERFEITING POLICY

Fairchild Semiconductor Corporation's Anti-Counterfeiting Policy. Fairchild's Anti-Counterfeiting Policy is also stated on our external website, www.Fairchildsemi.com, under Sales Support.

Counterfeiting of semiconductor parts is a growing problem in the industry. All manufactures of semiconductor products are experiencing counterfeiting of their parts. Customers who inadvertently purchase counterfeit parts experience many problems such as loss of brand reputation, substandard performance, failed application, and increased cost of production and manufacturing delays. Fairchild is taking strong measures to protect ourselves and our customers from the proliferation of counterfeit parts. Fairchild strongly encourages customers to purchase Fairchild parts either directly from Fairchild or from Authorized Fairchild Distributors who are listed by country on our web page cited above. Products customers buy either from Fairchild directly or from Authorized Fairchild Distributors are genuine parts, have full traceability, meet Fairchild's quality standards for handling and storage and provide access to Fairchild's full range of up-to-date technical and product information. Fairchild and our Authorized Distributors will stand behind all warranties and will appropriately address and warranty issues that may arise. Fairchild will not provide any warranty coverage or other assistance for parts bought from Unauthorized Sources. Fairchild is committed to combat this global problem and encourage our customers to do their part in stopping this practice by buying direct or from authorized distributors.

PRODUCT STATUS DEFINITIONS

Definition of Terms

| Datasheet Identification | Product Status | Definition |
|--------------------------|-----------------------|---|
| Advance Information | Formative / In Design | Datasheet contains the design specifications for product development. Specifications may change in any manner without notice. |
| Preliminary | First Production | Datasheet contains preliminary data; supplementary data will be published at a later date. Fairchild Semiconductor reserves the right to make changes at any time without notice to improve design. |
| No Identification Needed | Full Production | Datasheet contains final specifications. Fairchild Semiconductor reserves the right to make changes at any time without notice to improve the design. |
| Obsolete | Not In Production | Datasheet contains specifications on a product that is discontinued by Fairchild Semiconductor. The datasheet is for reference information only. |

Rev. I68