

SGR6N60UF

Ultra-Fast IGBT

General Description

Fairchild's UF series of Insulated Gate Bipolar Transistors (IGBTs) provides low conduction and switching losses. The UF series is designed for applications such as motor control and general inverters where high speed switching is a required feature.

Features

- High speed switching
- Low saturation voltage : $V_{CE(sat)} = 2.1 \text{ V @ } I_C = 3\text{A}$
- High input impedance

Applications

AC & DC motor controls, general purpose inverters, robotics, and servo controls.

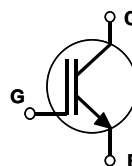
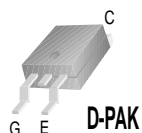

Absolute Maximum Ratings $T_C = 25^\circ\text{C}$ unless otherwise noted

Symbol	Description	SGR6N60UF	Units
V_{CES}	Collector-Emitter Voltage	600	V
V_{GES}	Gate-Emitter Voltage	± 20	V
I_C	Collector Current @ $T_C = 25^\circ\text{C}$	6	A
	Collector Current @ $T_C = 100^\circ\text{C}$	3	A
$I_{CM(1)}$	Pulsed Collector Current	25	A
P_D	Maximum Power Dissipation @ $T_C = 25^\circ\text{C}$	30	W
	Maximum Power Dissipation @ $T_C = 100^\circ\text{C}$	12	W
T_J	Operating Junction Temperature	-55 to +150	$^\circ\text{C}$
T_{stg}	Storage Temperature Range	-55 to +150	$^\circ\text{C}$
T_L	Maximum Lead Temp. for Soldering Purposes, 1/8" from Case for 5 Seconds	300	$^\circ\text{C}$

Notes :

(1) Repetitive rating : Pulse width limited by max. junction temperature

Thermal Characteristics

Symbol	Parameter	Typ.	Max.	Units
$R_{\theta JC}$	Thermal Resistance, Junction-to-Case	--	4.0	$^\circ\text{C/W}$
$R_{\theta JA}$	Thermal Resistance, Junction-to-Ambient (PCB Mount) (2)	--	50	$^\circ\text{C/W}$

Notes :

(2) Mounted on 1" square PCB (FR4 or G-10 Material)

Electrical Characteristics of the IGBT $T_C = 25^\circ\text{C}$ unless otherwise noted

Symbol	Parameter	Test Conditions	Min.	Typ.	Max.	Units
Off Characteristics						
BV_{CES}	Collector-Emitter Breakdown Voltage	$V_{GE} = 0V, I_C = 250\mu A$	600	--	--	V
$\Delta BV_{CES}/\Delta T_J$	Temperature Coefficient of Breakdown Voltage	$V_{GE} = 0V, I_C = 1mA$	--	0.6	--	V/ $^\circ\text{C}$
I_{CES}	Collector Cut-Off Current	$V_{CE} = V_{CES}, V_{GE} = 0V$	--	--	250	μA
I_{GES}	G-E Leakage Current	$V_{GE} = V_{GES}, V_{CE} = 0V$	--	--	± 100	nA
On Characteristics						
$V_{GE(th)}$	G-E Threshold Voltage	$I_C = 3mA, V_{CE} = V_{GE}$	3.5	4.5	6.5	V
$V_{CE(sat)}$	Collector to Emitter Saturation Voltage	$I_C = 3A, V_{GE} = 15V$	--	2.1	2.6	V
		$I_C = 6A, V_{GE} = 15V$	--	2.6	--	V
Dynamic Characteristics						
C_{ies}	Input Capacitance	$V_{CE} = 30V, V_{GE} = 0V,$ $f = 1MHz$	--	220	--	pF
C_{oes}	Output Capacitance		--	22	--	pF
C_{res}	Reverse Transfer Capacitance		--	7	--	pF
Switching Characteristics						
$t_{d(on)}$	Turn-On Delay Time	$V_{CC} = 300V, I_C = 3A,$ $R_G = 80\Omega, V_{GE} = 15V,$ Inductive Load, $T_C = 25^\circ\text{C}$	--	15	--	ns
t_r	Rise Time		--	25	--	ns
$t_{d(off)}$	Turn-Off Delay Time		--	60	130	ns
t_f	Fall Time		--	70	150	ns
E_{on}	Turn-On Switching Loss		--	57	--	μJ
E_{off}	Turn-Off Switching Loss		--	25	--	μJ
E_{ts}	Total Switching Loss	--	82	120	μJ	
$t_{d(on)}$	Turn-On Delay Time	$V_{CC} = 300V, I_C = 3A,$ $R_G = 80\Omega, V_{GE} = 15V,$ Inductive Load, $T_C = 125^\circ\text{C}$	--	22	--	ns
t_r	Rise Time		--	32	--	ns
$t_{d(off)}$	Turn-Off Delay Time		--	80	200	ns
t_f	Fall Time		--	122	300	ns
E_{on}	Turn-On Switching Loss		--	65	--	μJ
E_{off}	Turn-Off Switching Loss		--	46	--	μJ
E_{ts}	Total Switching Loss	--	111	170	μJ	
Q_g	Total Gate Charge	$V_{CE} = 300V, I_C = 3A,$ $V_{GE} = 15V$	--	15	22	nC
Q_{ge}	Gate-Emitter Charge		--	5	8	nC
Q_{gc}	Gate-Collector Charge		--	4	6	nC
L_e	Internal Emitter Inductance	Measured 5mm from PKG	--	7.5	--	nH

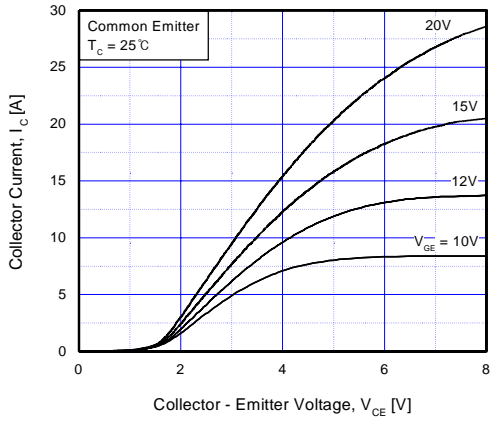

Fig 1. Typical Output Characteristics

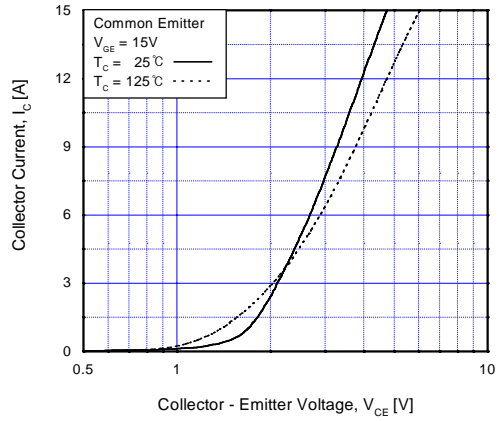

Fig 2. Typical Saturation Voltage Characteristics

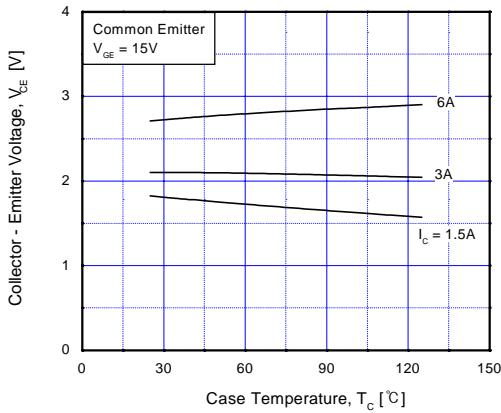

Fig 3. Saturation Voltage vs. Case Temperature at Variant Current Level

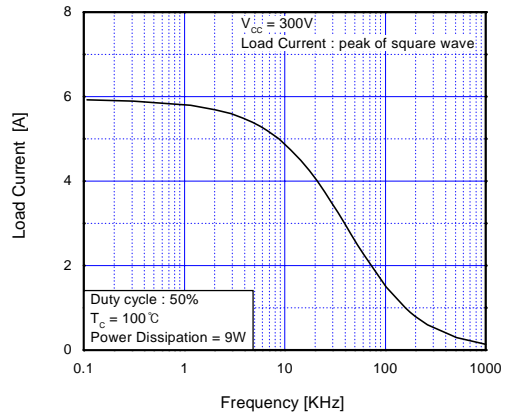

Fig 4. Load Current vs. Frequency

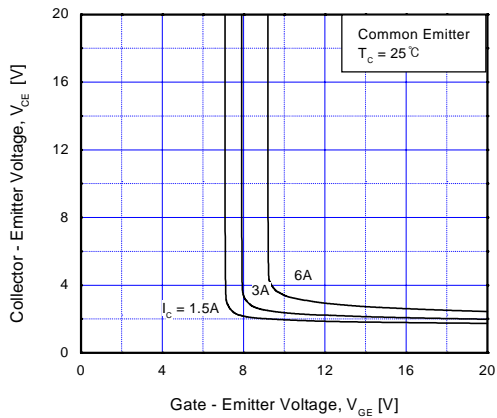

Fig 5. Saturation Voltage vs. V_{GE}

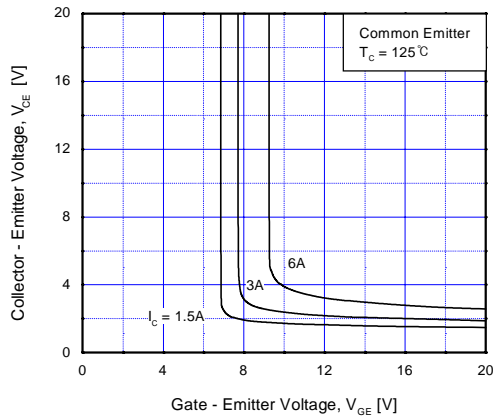

Fig 6. Saturation Voltage vs. V_{GE}

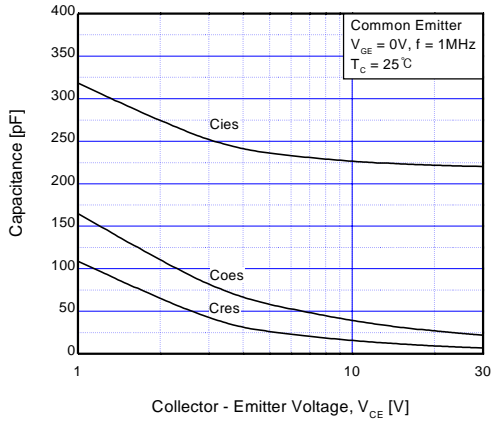

Fig 7. Capacitance Characteristics

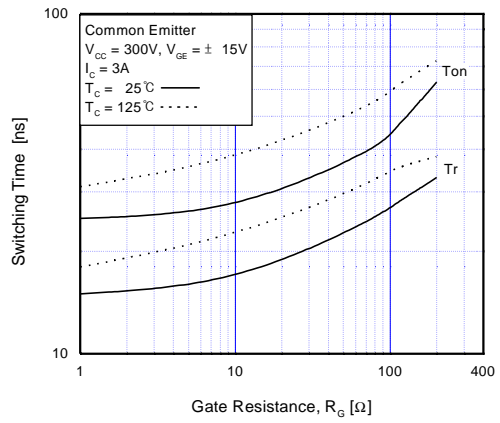

Fig 8. Turn-On Characteristics vs. Gate Resistance

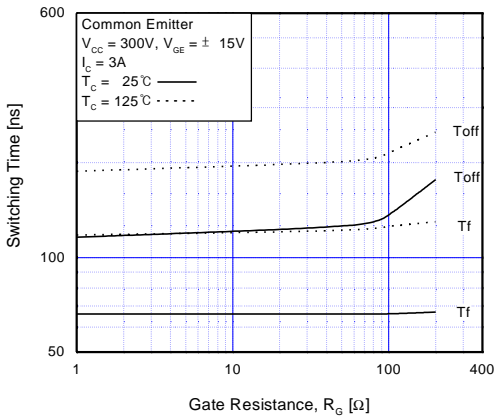

Fig 9. Turn-Off Characteristics vs. Gate Resistance

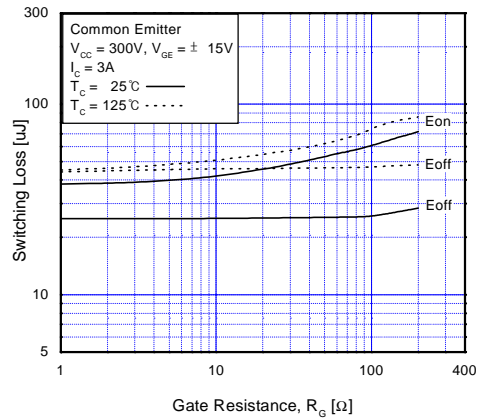

Fig 10. Switching Loss vs. Gate Resistance

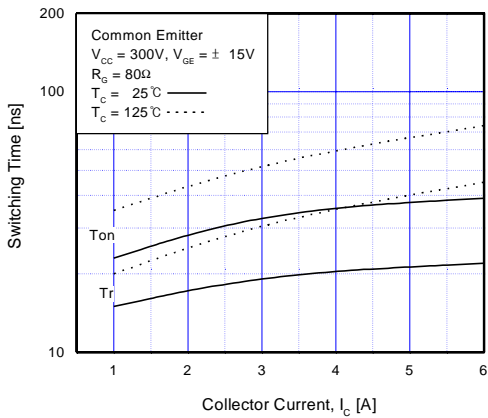

Fig 11. Turn-On Characteristics vs. Collector Current

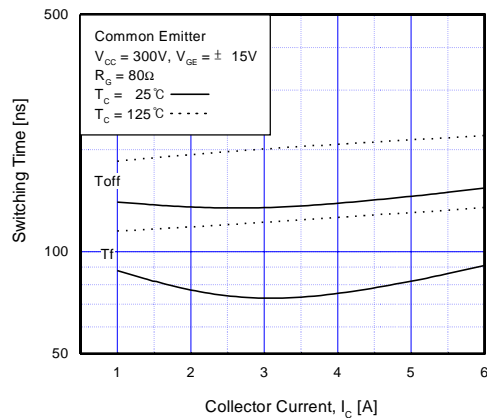

Fig 12. Turn-Off Characteristics vs. Collector Current

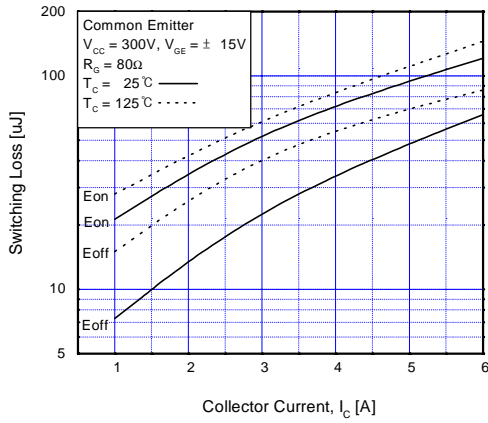

Fig 13. Switching Loss vs. Collector Current

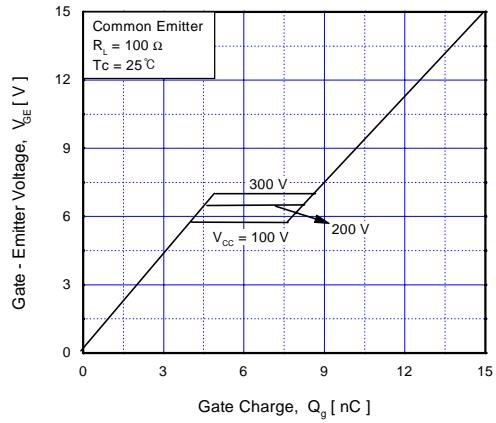

Fig 14. Gate Charge Characteristics

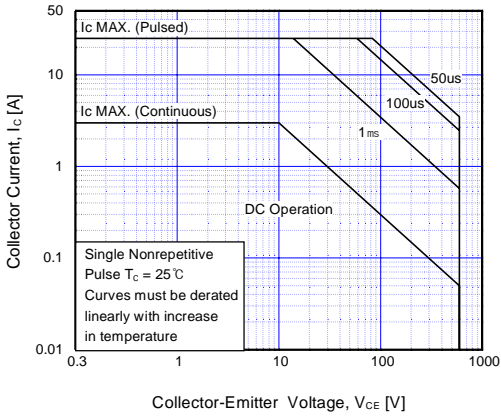

Fig 15. SOA Characteristics

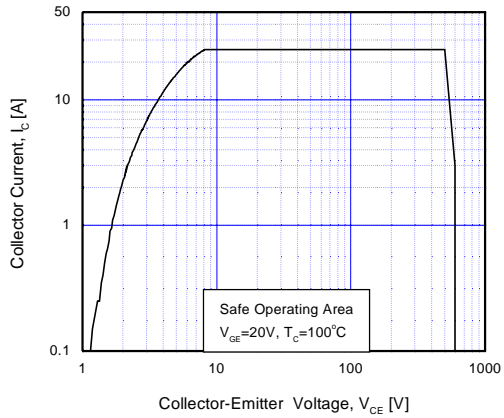

Fig 16. Turn-Off SOA Characteristics

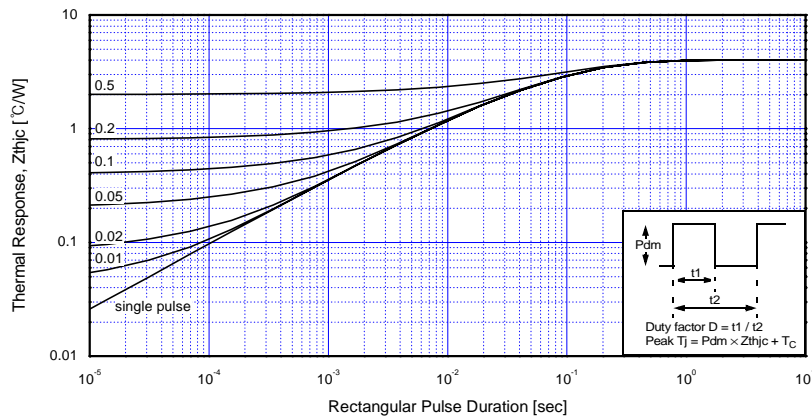
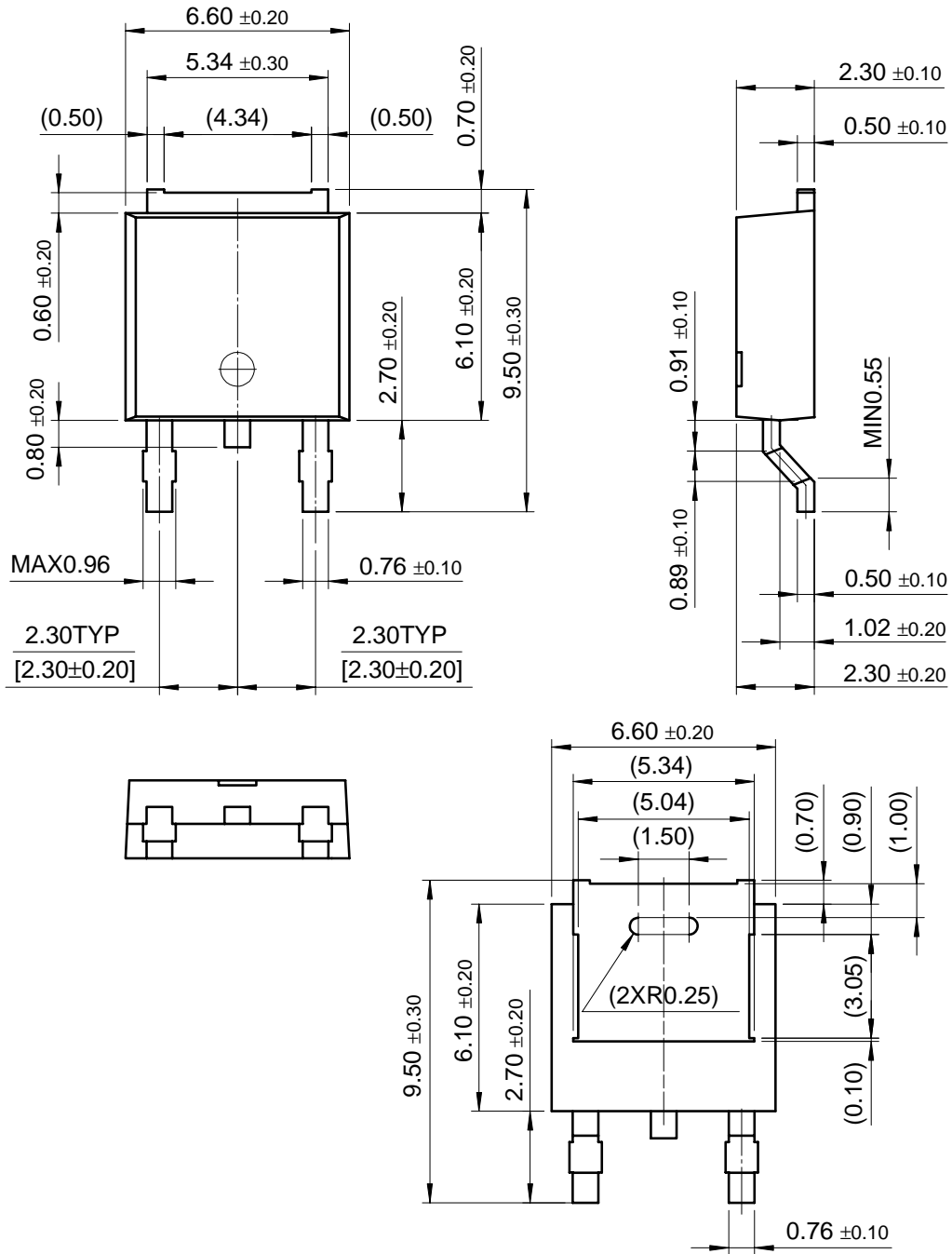

Fig 17. Transient Thermal Impedance of IGBT

Package Dimension

D-PAK



Dimensions in Millimeters

TRADEMARKS

The following are registered and unregistered trademarks Fairchild Semiconductor owns or is authorized to use and is not intended to be an exhaustive list of all such trademarks.

ACEx™	FAST®	MICROWIRE™	SLIENT SWITCHER®	UHC™
Bottomless™	FASTr™	OPTOLOGIC™	SMART START™	UltraFET®
CoolFET™	FRFET™	OPTOPLANAR™	SPM™	VCX™
CROSSVOLT™	GlobalOptoisolator™	PACMAN™	STAR*POWER™	
DenseTrench™	GTO™	POPT™	Stealth™	
DOMETM	HiSeC™	Power247™	SuperSOT™-3	
EcoSPARK™	I ² C™	PowerTrench®	SuperSOT™-6	
E ² CMOS™	ISOPLANAR™	QFET™	SuperSOT™-8	
EnSigna™	LittleFET™	QST™	SyncFET™	
FACT™	MicroFET™	QT Optoelectronics™	TinyLogic™	
FACT Quiet Series™	MicroPak™	Quiet Series™	TruTranslation™	

STAR*POWER is used under license

DISCLAIMER

FAIRCHILD SEMICONDUCTOR RESERVES THE RIGHT TO MAKE CHANGES WITHOUT FURTHER NOTICE TO ANY PRODUCTS HEREIN TO IMPROVE RELIABILITY, FUNCTION OR DESIGN. FAIRCHILD DOES NOT ASSUME ANY LIABILITY ARISING OUT OF THE APPLICATION OR USE OF ANY PRODUCT OR CIRCUIT DESCRIBED HEREIN; NEITHER DOES IT CONVEY ANY LICENSE UNDER ITS PATENT RIGHTS, NOR THE RIGHTS OF OTHERS.

LIFE SUPPORT POLICY

FAIRCHILD'S PRODUCTS ARE NOT AUTHORIZED FOR USE AS CRITICAL COMPONENTS IN LIFE SUPPORT DEVICES OR SYSTEMS WITHOUT THE EXPRESS WRITTEN APPROVAL OF FAIRCHILD SEMICONDUCTOR CORPORATION.

As used herein:

1. Life support devices or systems are devices or systems which, (a) are intended for surgical implant into the body, or (b) support or sustain life, or (c) whose failure to perform when properly used in accordance with instructions for use provided in the labeling, can be reasonably expected to result in significant injury to the user.
2. A critical component is any component of a life support device or system whose failure to perform can be reasonably expected to cause the failure of the life support device or system, or to affect its safety or effectiveness.

PRODUCT STATUS DEFINITIONS

Definition of Terms

Datasheet Identification	Product Status	Definition
Advance Information	Formative or In Design	This datasheet contains the design specifications for product development. Specifications may change in any manner without notice.
Preliminary	First Production	This datasheet contains preliminary data, and supplementary data will be published at a later date. Fairchild Semiconductor reserves the right to make changes at any time without notice in order to improve design.
No Identification Needed	Full Production	This datasheet contains final specifications. Fairchild Semiconductor reserves the right to make changes at any time without notice in order to improve design.
Obsolete	Not In Production	This datasheet contains specifications on a product that has been discontinued by Fairchild semiconductor. The datasheet is printed for reference information only.

Fairchild Semiconductor

SEARCH | [Parametric](#) | [Cross Reference](#)

space

Product Folders and

Applies

find products

[Home](#) >> [Find products](#) >>

[Products groups](#)

[Analog and Mixed](#)

[Signal](#)

[Discrete](#)

[Interface](#)

[Logic](#)

[Microcontrollers](#)

[Non-Volatile](#)

[Memory](#)

[Optoelectronics](#)

[Markets and](#)

[applications](#)

[New products](#)

[Product selection and](#)

[parametric search](#)

[Cross-reference](#)

[search](#)

SGR6N60UF

Discrete, High Performance IGBT

Contents

[General description](#) | [Features](#) | [Applications](#) |

[Product status/pricing/packageing](#)

Datasheet

[Download this](#)

[datasheet](#)

PDF

[e-mail this datasheet](#)

[E-]

This page [Print version](#)

Related Links

[Request samples](#)

[Dotted line](#)

[How to order products](#)

[Dotted line](#)

[Product Change Notices](#)

[\(PCNs\)](#)

[Dotted line](#)

[Support](#)

[Dotted line](#)

[Distributor and field sales](#)

[representatives](#)

[Dotted line](#)

[Quality and reliability](#)

[Dotted line](#)

[Design tools](#)

General description

Fairchild's UF series of Insulated Gate Bipolar Transistors (IGBTs) provides low conduction and switching losses. The UF series is designed for applications such as motor control and general inverters where high speed switching is a required feature.

[back to top](#)

Features

- High Speed Switching
- Low Saturation Voltage : $V_{CE(sat)} = 2.1$ V @ $I_C = 3A$
- High Input Impedance

[back to top](#)

Applications

AC &DC Motor controls, General Purpose Inverters, Robotics, Servo Controls

[back to top](#)

Product status/pricing/packageing

Product	Product status	Pricing*	Package type	Leads	Packing method
---------	----------------	----------	--------------	-------	----------------

technical information

buy products

technical support

my Fairchild

company

SGR6N60UFTF	Full Production	\$0.59	TO-252(DPAK)	2	TAPE REEL
SGR6N60UFTM	Full Production	\$0.59	TO-252(DPAK)	2	TAPE REEL

* 1,000 piece Budgetary Pricing

[back to top](#)

[Home](#) | [Find products](#) | [Technical information](#) | [Buy products](#) |
[Support](#) | [Company](#) | [Contact us](#) | [Site index](#) | [Privacy policy](#)

© [Copyright 2002 Fairchild Semiconductor](#)