

SSR1N60B / SSU1N60B

600V N-Channel MOSFET

General Description

These N-Channel enhancement mode power field effect transistors are produced using Fairchild's proprietary, planar, DMOS technology.

This advanced technology has been especially tailored to minimize on-state resistance, provide superior switching performance, and withstand high energy pulse in the avalanche and commutation mode. These devices are well suited for high efficiency switch mode power supplies.

Features

- 0.9A, 600V, $R_{DS(on)} = 12\Omega @ V_{GS} = 10V$
- Low gate charge (typical 5.9 nC)
- Low C_{rss} (typical 3.6 pF)
- Fast switching
- 100% avalanche tested
- Improved dv/dt capability

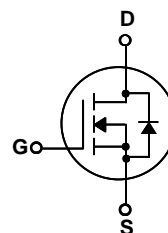
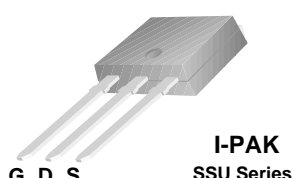
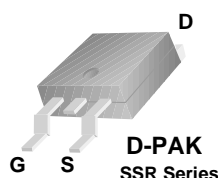

Absolute Maximum Ratings $T_C = 25^\circ\text{C}$ unless otherwise noted

Symbol	Parameter	SSR1N60B / SSU1N60B	Units
V_{DSS}	Drain-Source Voltage	600	V
I_D	Drain Current - Continuous ($T_C = 25^\circ\text{C}$) - Continuous ($T_C = 100^\circ\text{C}$)	0.9	A
		0.57	A
I_{DM}	Drain Current - Pulsed (Note 1)	3.0	A
V_{GSS}	Gate-Source Voltage	± 30	V
E_{AS}	Single Pulsed Avalanche Energy (Note 2)	50	mJ
I_{AR}	Avalanche Current (Note 1)	0.9	A
E_{AR}	Repetitive Avalanche Energy (Note 1)	2.8	mJ
dv/dt	Peak Diode Recovery dv/dt (Note 3)	5.5	V/ns
P_D	Power Dissipation ($T_A = 25^\circ\text{C}$) *	2.5	W
	Power Dissipation ($T_C = 25^\circ\text{C}$) - Derate above 25°C	28	W
		0.22	W/ $^\circ\text{C}$
T_J, T_{stg}	Operating and Storage Temperature Range	-55 to +150	$^\circ\text{C}$
T_L	Maximum lead temperature for soldering purposes, 1/8" from case for 5 seconds	300	$^\circ\text{C}$

Thermal Characteristics

Symbol	Parameter	Typ	Max	Units
$R_{\theta JC}$	Thermal Resistance, Junction-to-Case	--	4.53	$^\circ\text{C}/\text{W}$
$R_{\theta JA}$	Thermal Resistance, Junction-to-Ambient *	--	50	$^\circ\text{C}/\text{W}$
$R_{\theta JA}$	Thermal Resistance, Junction-to-Ambient	--	110	$^\circ\text{C}/\text{W}$

* When mounted on the minimum pad size recommended (PCB Mount)

Electrical Characteristics $T_C = 25^\circ\text{C}$ unless otherwise noted

Symbol	Parameter	Test Conditions	Min	Typ	Max	Units
Off Characteristics						
BV_{DSS}	Drain-Source Breakdown Voltage	$V_{GS} = 0\text{ V}, I_D = 250\ \mu\text{A}$	600	--	--	V
$\Delta BV_{DSS} / \Delta T_J$	Breakdown Voltage Temperature Coefficient	$I_D = 250\ \mu\text{A}$, Referenced to 25°C	--	0.65	--	$\text{V}/^\circ\text{C}$
I_{DSS}	Zero Gate Voltage Drain Current	$V_{DS} = 600\text{ V}, V_{GS} = 0\text{ V}$	--	--	10	μA
		$V_{DS} = 480\text{ V}, T_C = 125^\circ\text{C}$	--	--	100	μA
I_{GSSF}	Gate-Body Leakage Current, Forward	$V_{GS} = 30\text{ V}, V_{DS} = 0\text{ V}$	--	--	100	nA
I_{GSSR}	Gate-Body Leakage Current, Reverse	$V_{GS} = -30\text{ V}, V_{DS} = 0\text{ V}$	--	--	-100	nA

On Characteristics

$V_{GS(th)}$	Gate Threshold Voltage	$V_{DS} = V_{GS}, I_D = 250\ \mu\text{A}$	2.0	--	4.0	V
$R_{DS(on)}$	Static Drain-Source On-Resistance	$V_{GS} = 10\text{ V}, I_D = 0.45\text{ A}$	--	9.7	12	Ω
g_{FS}	Forward Transconductance	$V_{DS} = 40\text{ V}, I_D = 0.45\text{ A}$ (Note 4)	--	0.92	--	S

Dynamic Characteristics

C_{iss}	Input Capacitance	$V_{DS} = 25\text{ V}, V_{GS} = 0\text{ V},$ $f = 1.0\text{ MHz}$	--	165	215	pF
C_{oss}	Output Capacitance		--	18	25	pF
C_{riss}	Reverse Transfer Capacitance		--	3.6	4.7	pF

Switching Characteristics

$t_{d(on)}$	Turn-On Delay Time	$V_{DD} = 300\text{ V}, I_D = 1.0\text{ A},$ $R_G = 25\ \Omega$	--	14	40	ns
t_r	Turn-On Rise Time		--	45	100	ns
$t_{d(off)}$	Turn-Off Delay Time		--	25	60	ns
t_f	Turn-Off Fall Time		(Note 4, 5)	--	35	80
Q_g	Total Gate Charge	$V_{DS} = 480\text{ V}, I_D = 1.0\text{ A},$ $V_{GS} = 10\text{ V}$	--	5.9	7.7	nC
Q_{gs}	Gate-Source Charge		--	1.0	--	nC
Q_{gd}	Gate-Drain Charge		(Note 4, 5)	--	2.7	--

Drain-Source Diode Characteristics and Maximum Ratings

I_S	Maximum Continuous Drain-Source Diode Forward Current	--	--	0.9	A	
I_{SM}	Maximum Pulsed Drain-Source Diode Forward Current	--	--	3.0	A	
V_{SD}	Drain-Source Diode Forward Voltage	$V_{GS} = 0\text{ V}, I_S = 0.9\text{ A}$	--	--	1.4	V
t_{rr}	Reverse Recovery Time	$V_{GS} = 0\text{ V}, I_S = 1.0\text{ A},$	--	180	--	ns
Q_{rr}	Reverse Recovery Charge	$di_F / dt = 100\text{ A}/\mu\text{s}$ (Note 4)	--	0.47	--	μC

Notes:

1. Repetitive Rating : Pulse width limited by maximum junction temperature
2. $L = 115\text{mH}, I_{AS} = 0.9\text{A}, V_{DD} = 50\text{V}, R_G = 25\ \Omega$, Starting $T_J = 25^\circ\text{C}$
3. $I_{SD} \leq 1.0\text{A}, di/dt \leq 300\text{A}/\mu\text{s}, V_{DD} \leq BV_{DSS}$, Starting $T_J = 25^\circ\text{C}$
4. Pulse Test : Pulse width $\leq 300\mu\text{s}$, Duty cycle $\leq 2\%$
5. Essentially independent of operating temperature

Typical Characteristics

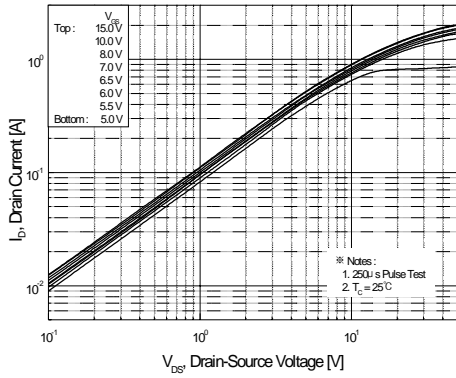

Figure 1. On-Region Characteristics

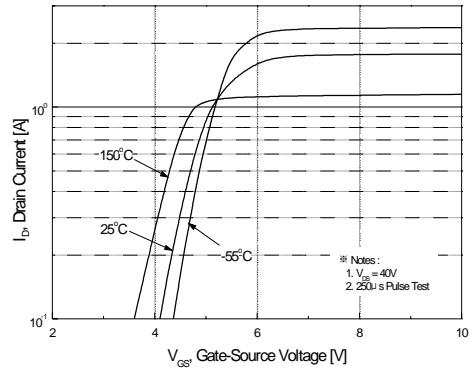

Figure 2. Transfer Characteristics

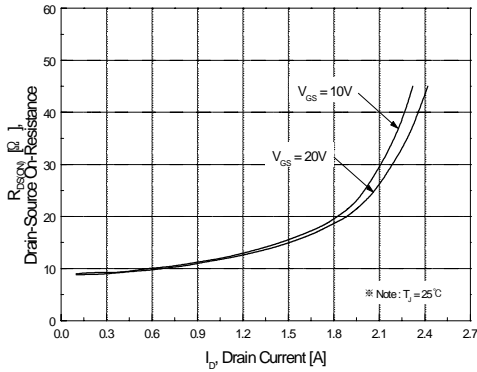

Figure 3. On-Resistance Variation vs. Drain Current and Gate Voltage

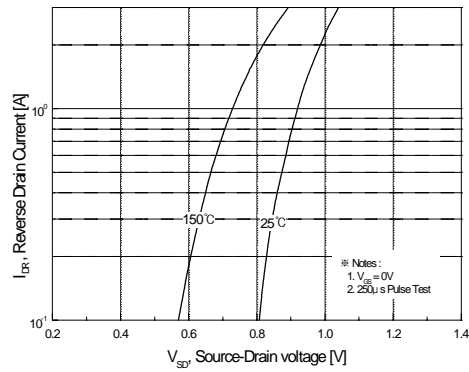

Figure 4. Body Diode Forward Voltage Variation with Source Current and Temperature

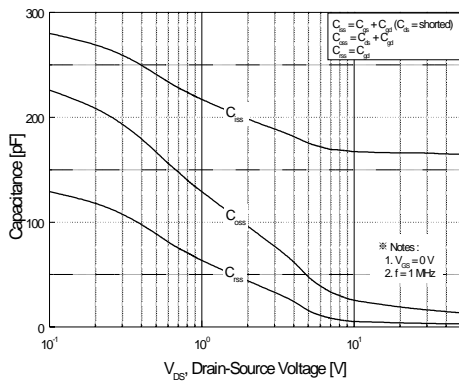

Figure 5. Capacitance Characteristics

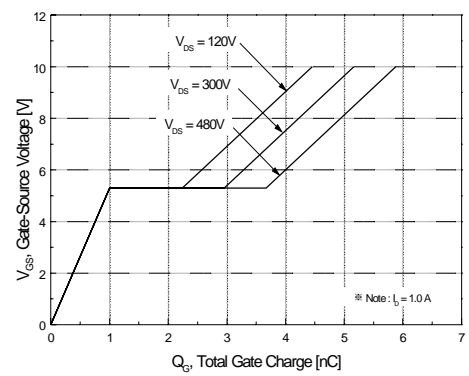

Figure 6. Gate Charge Characteristics

Typical Characteristics (Continued)

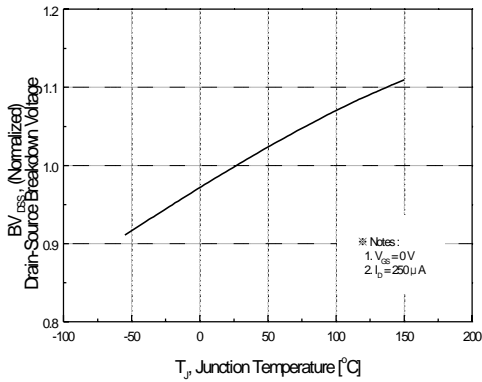

Figure 7. Breakdown Voltage Variation vs Temperature

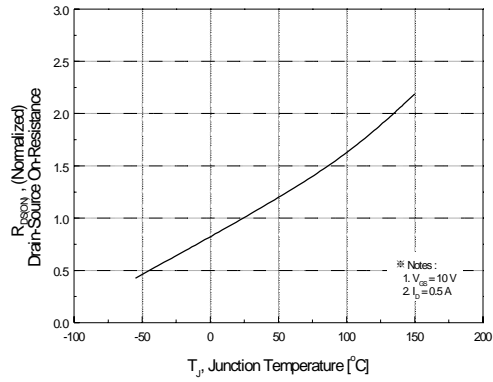

Figure 8. On-Resistance Variation vs Temperature

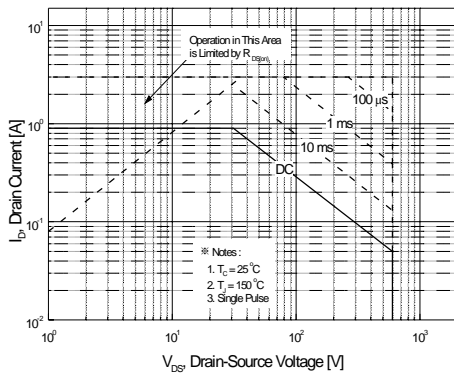

Figure 9. Maximum Safe Operating Area

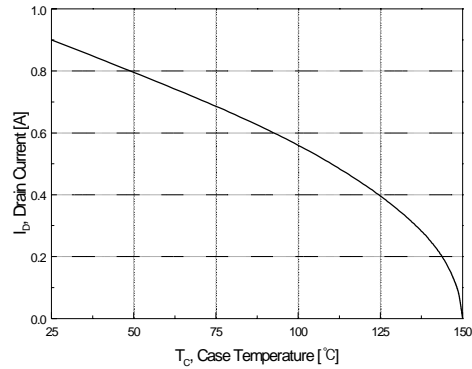

Figure 10. Maximum Drain Current vs Case Temperature

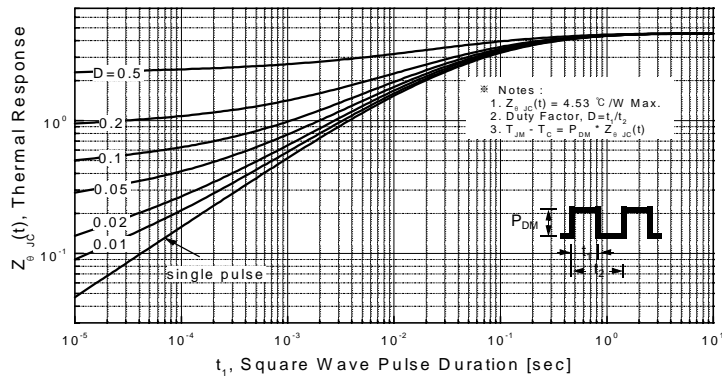

Figure 11. Transient Thermal Response Curve

Gate Charge Test Circuit & Waveform



Resistive Switching Test Circuit & Waveforms



Unclamped Inductive Switching Test Circuit & Waveforms



Package Dimensions

D-PAK

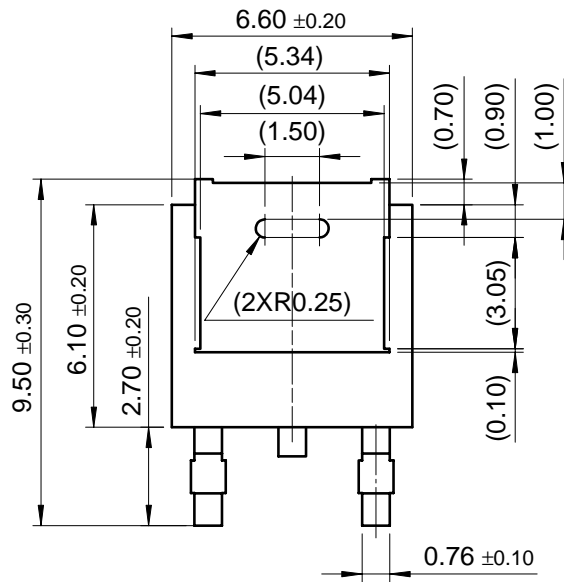
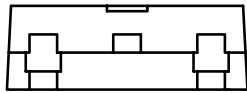
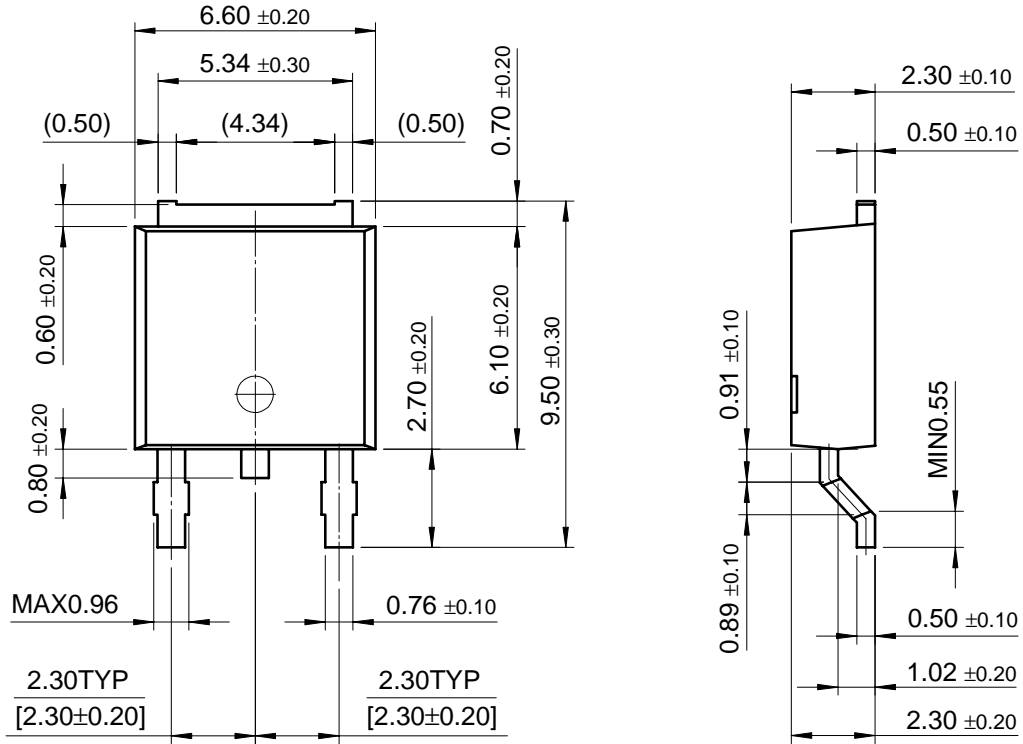

Dimensions in Millimeters

Package Dimensions (Continued)

I-PAK

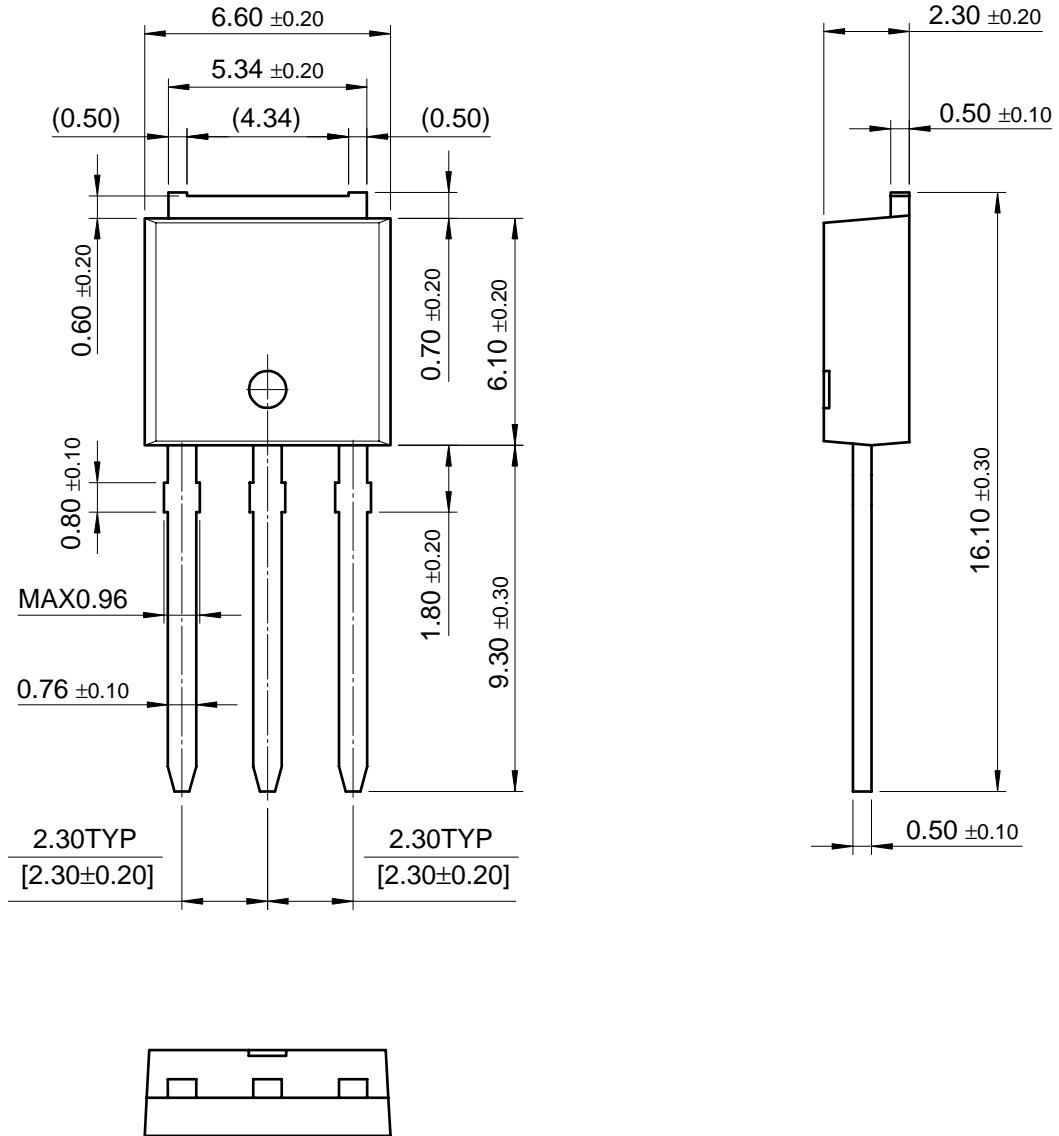

SSR1N60B / SSU1N60B

Dimensions in Millimeters

TRADEMARKS

The following are registered and unregistered trademarks Fairchild Semiconductor owns or is authorized to use and is not intended to be an exhaustive list of all such trademarks.

ACE _x TM	FAST [®]	OPTOLOGIC TM	SMART START TM	VCX TM
Bottomless TM	FAST _r TM	OPTOPLANAR TM	STAR*POWER TM	
CoolFET TM	FRFET TM	PACMAN TM	Stealth TM	
CROSSVOLT TM	GlobalOptoisolator TM	POP TM	SuperSOT TM -3	
DenseTrench TM	GTO TM	Power247 TM	SuperSOT TM -6	
DOMET TM	HiSeC TM	PowerTrench [®]	SuperSOT TM -8	
EcoSPARK TM	ISOPLANAR TM	QFET TM	SyncFET TM	
E ² CMOS TM	LittleFET TM	QS TM	TruTranslation TM	
EnSigna TM	MicroFET TM	QT Optoelectronics TM	TinyLogic TM	
FACT TM	MicroPak TM	Quiet Series TM	UHC TM	
FACT Quiet Series TM	MICROWIRE TM	SLIENT SWITCHER [®]	UltraFET [®]	

STAR*POWER is used under license

DISCLAIMER

FAIRCHILD SEMICONDUCTOR RESERVES THE RIGHT TO MAKE CHANGES WITHOUT FURTHER NOTICE TO ANY PRODUCTS HEREIN TO IMPROVE RELIABILITY, FUNCTION OR DESIGN. FAIRCHILD DOES NOT ASSUME ANY LIABILITY ARISING OUT OF THE APPLICATION OR USE OF ANY PRODUCT OR CIRCUIT DESCRIBED HEREIN; NEITHER DOES IT CONVEY ANY LICENSE UNDER ITS PATENT RIGHTS, NOR THE RIGHTS OF OTHERS.

LIFE SUPPORT POLICY

FAIRCHILD'S PRODUCTS ARE NOT AUTHORIZED FOR USE AS CRITICAL COMPONENTS IN LIFE SUPPORT DEVICES OR SYSTEMS WITHOUT THE EXPRESS WRITTEN APPROVAL OF FAIRCHILD SEMICONDUCTOR CORPORATION.

As used herein:

1. Life support devices or systems are devices or systems which, (a) are intended for surgical implant into the body, or (b) support or sustain life, or (c) whose failure to perform when properly used in accordance with instructions for use provided in the labeling, can be reasonably expected to result in significant injury to the user.
2. A critical component is any component of a life support device or system whose failure to perform can be reasonably expected to cause the failure of the life support device or system, or to affect its safety or effectiveness.

PRODUCT STATUS DEFINITIONS

Definition of Terms

Datasheet Identification	Product Status	Definition
Advance Information	Formative or In Design	This datasheet contains the design specifications for product development. Specifications may change in any manner without notice.
Preliminary	First Production	This datasheet contains preliminary data, and supplementary data will be published at a later date. Fairchild Semiconductor reserves the right to make changes at any time without notice in order to improve design.
No Identification Needed	Full Production	This datasheet contains final specifications. Fairchild Semiconductor reserves the right to make changes at any time without notice in order to improve design.
Obsolete	Not In Production	This datasheet contains specifications on a product that has been discontinued by Fairchild semiconductor. The datasheet is printed for reference information only.

Fairchild Semiconductor

SEARCH | Parametric | Cross Reference

space

Product Folders and

Applies

find products

Home >> Find products >>

Products groups

Analog and Mixed

Signal

Discrete

Interface

Logic

Microcontrollers

Non-Volatile

Memory

Optoelectronics

Markets and

applications

New products

Product selection and

parametric search

Cross-reference

search

SSU1N60B

600V N-Channel B-FET / Substitute of SSU1N60A

Contents

[General description](#) | [Features](#) | [Product status/pricing/packaging](#)

Datasheet

[Download this datasheet](#)

PDF

[e-mail this datasheet](#)

[E-]

This page [Print version](#)

Related Links

[Request samples](#)

[Dotted line](#)

[How to order products](#)

[Dotted line](#)

[Product Change Notices \(PCNs\)](#)

[Dotted line](#)

[Support](#)

[Dotted line](#)

[Distributor and field sales representatives](#)

[Dotted line](#)

[Quality and reliability](#)

[Dotted line](#)

[Design tools](#)

General description

These N-Channel enhancement mode power field effect transistors are produced using Fairchild's proprietary, planar, DMOS technology.

This advanced technology has been especially tailored to minimize on-state resistance, provide superior switching performance, and withstand high energy pulse in the avalanche and commutation mode. These devices are well suited for high efficiency switch mode power supplies.

[back to top](#)

Features

- 0.9A, 600V,
 - $R_{DS(on)} = 12\Omega @ V_{GS} = 10V$
- Low gate charge (typical 5.9 nC)
- Low Crss (typical 3.6 pF)
- Fast switching
- 100% avalanche tested
- Improved dv/dt capability

[back to top](#)

Product status/pricing/packaging

Product	Product status	Pricing*	Package type	Leads	Packing method

technical information

buy products

technical support

my Fairchild

company

SSU1N60BTU	Full Production	\$0.379	TO-251(IPAK)	3	RAIL
------------	-----------------	---------	--------------	---	------

* 1,000 piece Budgetary Pricing

[back to top](#)

[Home](#) | [Find products](#) | [Technical information](#) | [Buy products](#) |
[Support](#) | [Company](#) | [Contact us](#) | [Site index](#) | [Privacy policy](#)

[© Copyright 2002 Fairchild Semiconductor](#)

Fairchild Semiconductor

SEARCH | Parametric | Cross Reference

space

Product Folders and

Applies

find products

Home >> Find products >>

Products groups

Analog and Mixed

Signal

Discrete

Interface

Logic

Microcontrollers

Non-Volatile

Memory

Optoelectronics

Markets and

applications

New products

Product selection and

parametric search

Cross-reference

search

SSR1N60B
600V N-Channel B-FET / Substitute of
SSP1N60A

Contents

[General description](#) | [Features](#) | [Product status/pricing/package](#)

General description

These N-Channel enhancement mode power field effect transistors are produced using Fairchild's proprietary, planar, DMOS technology.

This advanced technology has been especially tailored to minimize on-state resistance, provide superior switching performance, and withstand high energy pulse in the avalanche and commutation mode. These devices are well suited for high efficiency switch mode power supplies.

[back to top](#)

Features

- 0.9A, 600V,
 - $R_{DS(on)} = 12\Omega @ V_{GS} = 10V$
- Low gate charge (typical 5.9 nC)
- Low Crss (typical 3.6 pF)
- Fast switching
- 100% avalanche tested
- Improved dv/dt capability

[back to top](#)

Product status/pricing/package

Related Links

[Request samples](#)

[Dotted line](#)

[How to order products](#)

[Dotted line](#)

[Product Change Notices](#)

[\(PCNs\)](#)

[Dotted line](#)

[Support](#)

[Dotted line](#)

[Distributor and field sales](#)

[representatives](#)

[Dotted line](#)

[Quality and reliability](#)

[Dotted line](#)

[Design tools](#)

Datasheet

[Download this](#)

[datasheet](#)

PDF

[e-mail this datasheet](#)

[E-]

This page [Print version](#)

technical information

buy products

technical support

my Fairchild

company

Product	Product status	Pricing*	Package type	Leads	Packing method

SSR1N60BTM	Full Production	\$0.353	TO-252(DPAK)	2	TAPE REEL
SSR1N60BTF	Full Production	\$0.379	TO-252(DPAK)	2	TAPE REEL

* 1,000 piece Budgetary Pricing

[back to top](#)

[Home](#) | [Find products](#) | [Technical information](#) | [Buy products](#) |
[Support](#) | [Company](#) | [Contact us](#) | [Site index](#) | [Privacy policy](#)

[© Copyright 2002 Fairchild Semiconductor](#)
