

FAN5775

Synchronous Boost and Series / Parallel 10-LED Driver

Features

- Synchronous Current-Mode Boost Converter
- 1120 mW Output Power
- Drives up to 10 LEDs at up to 28 mA Each in a Configuration of 5 Strings of 2 LEDs in Series
- 5 LED Outputs: High-Side Current Sources
- PWM Dimming Control to Support Various Lighting Applications, such as Backlighting LCD Displays and Keypad Illumination
- Selectable LED Current
- High System Efficiency: $\leq 88\%$
- 2.3 V to 4.8 V Input Voltage Range
- 1.8 MHz Switching Frequency
- Input Under-Voltage Lockout (UVLO)
- Output Over-Voltage Protection (OVP)
- Short-Circuit and Thermal Shutdown (TSD) Protection
- 12-Bump, 0.4 mm Pitch, 1.41 x 1.80 x 0.50 mm WLCSP

Applications

- Mid-and Large-Size LCD Modules
- Cellular Mobile Handsets, Smart Phones
- Smart Books, Netbooks, MIDs
- Pocket PCs
- WLAN DC-DC Converter Modules
- PDA, DSC, PMP, and MP3 Players

Description

The FAN5775 is a synchronous, constant-current LED driver capable of efficiently driving up to ten LEDs in a five-string, two-series-LEDs-per-string configuration. Optimized for small form-factor applications, the 1.8 MHz switching frequency allows the use of tiny chip inductors and capacitors.

For safety, the device features integrated over-voltage, short-circuit, and thermal shutdown protections. In addition, input under-voltage lockout protection is triggered if the battery voltage is too low.

The FAN5775 is comprised of low-dropout, high-side current sources, enabling high-efficiency delivery of power from the battery to the LEDs. The LED current control is established with a series R_{SET} resistor, which is connected between the internal voltage reference on the chip and ground. The series resistor can be changed even during operation. In addition, the maximum current level can be set using an external logic control, allowing more dynamic range for dimming schemes, depending on ambient light conditions.

During operation, the FAN5775 holds the boost regulator's voltage on C_{OUT} during the off cycle of the PWM dimming, which helps minimize audible noise.

The FAN5775 is available in a very low profile, small-form-factor 1.41 x 1.80 x 0.50 mm, 12-bump WLCSP package that is "green" and RoHS compliant.

Ordering Information

Part Number	Temperature Range	Package	Packing
FAN5775UCX	-40°C to 85°C	12-Bump, Wafer-Level Chip-Scale Package (WLCSP), 1.41 x 1.80 x 0.50 mm, 0.40 mm Pitch	Tape and Reel

Block Diagram

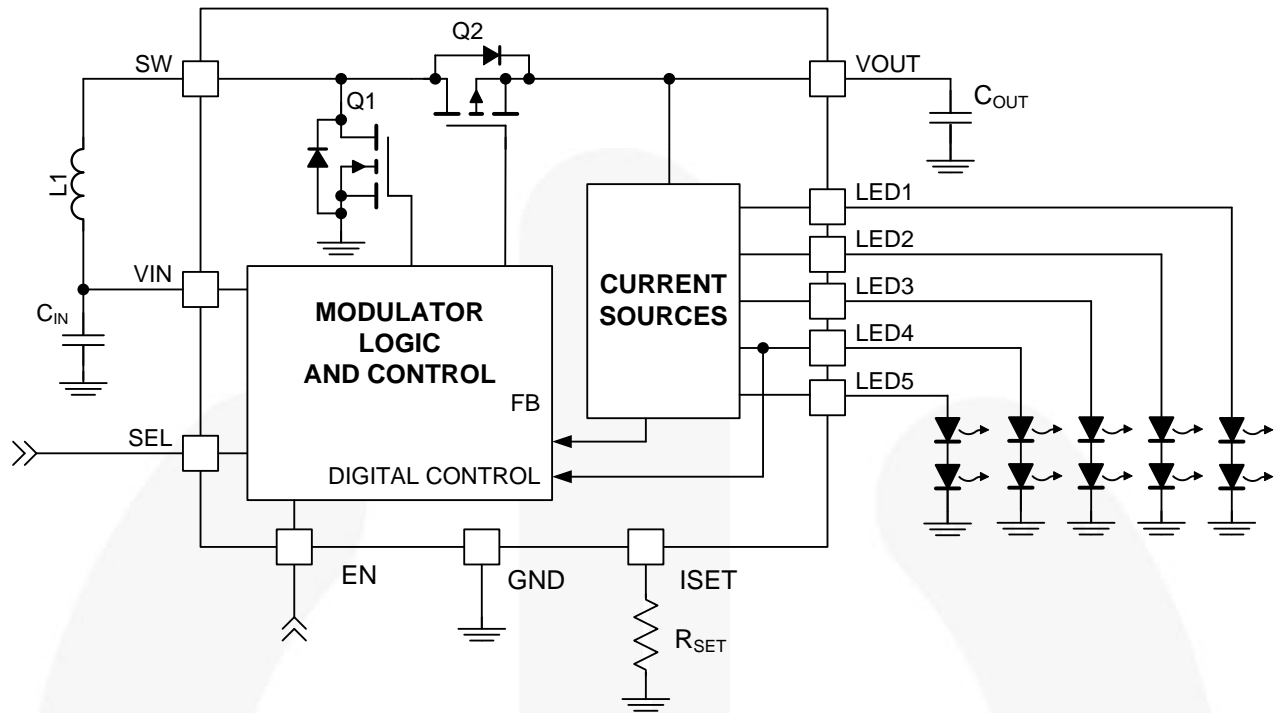

Figure 1. Typical Application Block Diagram

Table 1. Recommended External Components

Component	Description	Vendor	Parameter	Min.	Typ.	Max.	Units
L ₁	I _{L1} = 1000 mA	Various	L	1.50	4.70		μH
			R		130	155	mΩ
R _{SET}	1% or Better	Various	R	18		200	kΩ
C _{OUT}	10 μF, 25 V, X5R, 2012	Murata GRM219R61A116UE82	C	4.2	10.0	20.0	μF
C _{IN}	2.2 μF, 10 V, X5R, 1005	Murata GRM155R61A225KE95	C		2.2		μF

Pin Configuration

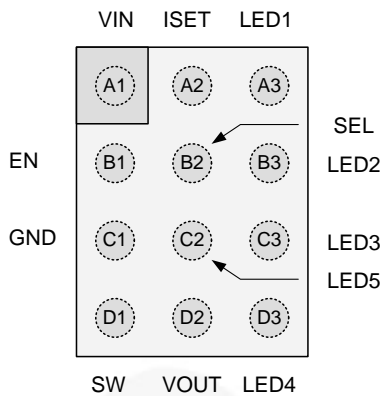

Figure 2. Top View (Bump Face Down)

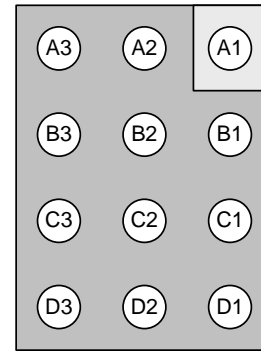

Figure 3. Bottom View (Bump Face Up)

Pin Definitions

Pin #	Name	Description
A1	VIN	Input voltage.
A2	ISET	A resistor from the internal reference to GND is measured to determine the LED current setting. This resistor value sets current for the LED strings in RSET Mode. If the device is used in FULL Mode only, ISET must be connected with a resistor of valid range or to GND.
A3	LED1	LED string #1 output.
B1	EN	Enable/PWM pin for LED1 - LED5. A logic LOW on this pin turns off the LED drivers. The IC goes to shutdown 30 ms after the enable pin is set LOW. It is connected to an internal pull-down resistor of 280 kΩ.
B2	SEL	RSET/FULL mode selection. 1-wire interface to program the current. RSET Mode (SEL = LOW), internal current multiplier is 400, and FULL Mode (SEL = HIGH); programmed output current = 28 mA (default) per string. It is connected to an internal pull-down resistor of 280 kΩ.
B3	LED2	LED string #2 output.
C1	GND	Ground. All power and analog signals are referenced to this pin.
C2	LED5	LED string #5 output.
C3	LED3	LED string #3 output.
D1	SW	Switching node. Tie inductor L1 from VIN to this pin.
D2	VOUT	Boost output voltage used to supply the LED current sources. This voltage is regulated to the minimum value required to ensure adequate voltage across all active LED current sources.
D3	LED4	LED string #4 output.

Absolute Maximum Ratings

Stresses exceeding the absolute maximum ratings may damage the device. The device may not function or be operable above the recommended operating conditions and stressing the parts to these levels is not recommended. In addition, extended exposure to stresses above the recommended operating conditions may affect device reliability. The absolute maximum ratings are stress ratings only.

Symbol	Parameter	Min.	Max.	Units
V_{IN}	Supply Voltage	-0.3	6.0	V
V_{ISET}	ISET Voltage	-0.3	$V_{IN} + 0.3$	V
V_{EN}	EN and SEL Pin Maximum Voltage	-0.3	6.0	V
V_{OVP}	VOUT, SW, and LEDx Drive Pins' Maximum Voltage	-0.3	10.0	V
ESD	Electrostatic Discharge Protection Level	Human Body Model per JESD22-A114	2.0	kV
		Charged Device Model per JESD22-C101	1.0	
T_A	Operating Ambient Temperature	-40	+85	°C
T_J	Junction Temperature	-40	+150	°C
T_{STG}	Storage Temperature	-65	+150	°C
T_L	Lead Soldering Temperature, 10 Seconds		+260	°C

Recommended Operating Conditions

The Recommended Operating Conditions table defines the conditions for actual device operation. Recommended operating conditions are specified to ensure optimal performance to the datasheet specifications. Fairchild does not recommend exceeding them or designing to absolute maximum ratings.

Symbol	Parameter	Min.	Typ.	Max.	Units
V_{IN}	V_{IN} Supply Voltage	2.3	3.7	4.8	V
V_{OUT}	V_{OUT} Voltage ⁽¹⁾	3.5		8.5	V
$I_{LED(FS)}$	Full-Scale LED Current per Channel	2.5		28.0	mA
T_A	Ambient Temperature	-40		+85	°C
T_J	Junction Temperature	-40		+125	°C

Note:

- The minimum V_{OUT} must be 3.5 V to guarantee a maximum LED current of 28mA for each LED pin. Internally, the device sets a minimum $V_{OUT} = V_{IN} + 0.2$ V and the LED driver dropout is increased accordingly. If $V_F < 3.3$ V and $V_{IN} < 3.3$ V, V_{OUT} voltage has to be forced above 3.5 V by connecting for example series resistor for one of the LED-strings.

Thermal Properties

Junction-to-ambient thermal resistance is a function of application and board layout. This data is measured with four-layer 2s2p boards in accordance to JEDEC standard JESD51. Special attention must be paid not to exceed junction temperature $T_{J(max)}$ at a given ambient temperature T_A .

Symbol	Parameter	Min.	Typ.	Max.	Units
θ_{JA}	Junction-to-Ambient Thermal Resistance		90		°C/W

Electrical Specifications

Unless otherwise specified: $V_{IN} = 2.3\text{ V to }4.8\text{ V}$, $T_A = -40^\circ\text{C to }+85^\circ\text{C}$, and $EN = V_{IN}$, $SEL = 0\text{ V}$. Typical values are $V_{IN} = 3.7\text{ V}$, $T_A = +25^\circ\text{C}$, $V_{OUT} = 6.7\text{ V}$, $I_{LED1-5} = 28\text{ mA}$. Circuit and components are according to Figure 1.

Symbol	Parameters	Conditions	Min.	Typ.	Max.	Units
Power Supplies						
I_{SD}	Shutdown Current	Device Disabled ($EN = 0\text{ V}$), $V_{IN} = 2.3\text{ V to }4.8\text{ V}$		0.5	2.0	μA
V_{UVLO}	Under-Voltage Lockout Threshold	Rising V_{IN}		2.1	2.2	V
		Falling V_{IN}	1.8	1.9		V
V_{UVHYST}	Under-Voltage Lockout Hysteresis			200		mV
Oscillator						
f_{SW}	Switching Frequency	PWM Mode CCM		1.8		MHz
Boost Regulator						
$V_{OUT-RIPPLE}$	Output Voltage Ripple	$BW = 20\text{ MHz}$			100	mV
I_{LIM-PK}	Peak Switch Current Limit ⁽²⁾	Open Loop, $V_{IN} = 2.3\text{ V to }4.8\text{ V}$		1000	1300	mA
$I_{SOFT-PK}$	Soft-Start Peak Switch Current	Open Loop		350		mA
I_{LOAD}	Maximum Continuous Output Current ⁽³⁾	$V_{IN} > 2.5\text{ V}$, $V_{OUT} = 7.5\text{ V}$	140			mA
η_{SYSTEM}	System Efficiency as a Function of LED Current PWM Duty Cycle ⁽³⁾	$V_{IN} = 3.7\text{ V}$, $V_{LED} = 6.5\text{ V}$, PWM = 100%	Total $I_{LED} = 25\text{ mA}$	83		%
			Total $I_{LED} = 80\text{ mA}$	86		
			Total $I_{LED} = 115\text{ mA}$	87	88	
			Total $I_{LED} = 140\text{ mA}$	85		
		$V_{IN} = 3.7\text{ V}$, $V_{LED} = 6.5\text{ V}$, PWM = 1%, 1600 Hz	Total $I_{LED} = 80\text{ mA}$	75		
Total $I_{LED} = 115\text{ mA}$	75					
LED Current Driver Characteristics						
$\Delta I_{LED}/I_{LED}$	Line Transient Response to V_{IN} Variations ⁽³⁾	Relative Response to 350 mV Pulses			10	%
		Response to 350 mV Pulses Integrated Over 20 ms period			1	
V_{LED_DO}	LED Driver Drop-Out Voltage ⁽⁵⁾			260		mV
f_{PWM}	LED PWM Frequency ⁽³⁾		100		1600	Hz
I_{LED_ACC}	LED Current Accuracy (R_{SET} Connected to ISET Pin)	Variation within each I_{LEDx} Output. Pin Voltage Difference < 250 mV ⁽⁴⁾ , $SEL = 0$, $2.70\text{ V} \leq V_{IN} \leq 4.35\text{ V}$	$2.5\text{ mA} \leq I_{LED} < 8\text{ mA}$		9.0	%
			$8\text{ mA} \leq I_{LED} \leq 20\text{ mA}$		7.5	
			$20\text{ mA} \leq I_{LED} \leq 28\text{ mA}$		7.0	
I_{LED_ACC}	LED Current Accuracy ⁽⁶⁾ (Internal Accuracy)	Variation within each I_{LEDx} output. Pin Voltage Difference < 250 mV ⁽⁴⁾ , $SEL = 1$ Pulsed for Different I_{LEDx} : 25 mA, 26 mA, 27 mA, 28 mA			7.0	%
I_{LED_MATCH}	LED Current Matching	Variation between Different $I_{LED1} - I_{LED5}$ Currents. Matching LED Pin Voltage Difference < 250 mV ⁽⁴⁾ , $2.70\text{ V} \leq V_{IN} \leq 4.35\text{ V}$	$2.5\text{ mA} \leq I_{LED} < 15\text{ mA}$		6.5	%
			$15\text{ mA} \leq I_{LED} \leq 23\text{ mA}$		6.0	
			$23\text{ mA} \leq I_{LED} \leq 25\text{ mA}$		5.0	
			$25\text{ mA} \leq I_{LED} \leq 28\text{ mA}$		4.5	
$I_{LINEARITY}$	LED Current Linearity ⁽³⁾	$2/255 \leq PWM \leq 24/255$, 1600 Hz			10	%
		$PWM \geq 25/255$, 1600 Hz			2	

Continued on the following page...

Electrical Specifications

Unless otherwise specified: $V_{IN} = 2.3\text{ V}$ to 4.8 V , $T_A = -40^\circ\text{C}$ to $+85^\circ\text{C}$, and $EN = V_{IN}$, $SEL = 0\text{ V}$. Typical values are $V_{IN} = 3.7\text{ V}$, $T_A = +25^\circ\text{C}$, $V_{OUT} = 6.7\text{ V}$, $I_{LED1-5} = 28\text{ mA}$. Circuit and components are according to Figure 1.

Symbol	Parameters	Conditions	Min.	Typ.	Max.	Units
I_{LED_RIPPLE}	Peak-to-Peak LED Current Ripple ⁽³⁾	$V_{LED_DO} \leq 0.6\text{ V}$, $f_{PWM} = 300\text{ Hz}$, Measurement, $BW = 500\text{ kHz}$		0.4	1.2	mA_{P-P}
$I_{LEAKAGE}$	LED Driver Leakage	In OFF State			0.5	μA
V_{ISET}	ISET Voltage			1.25		V
I_{SET}	ISET Ratio	Current Mirror Ratio; $SEL = 0$, Normal Mode		400		
I_{LED_MAX}	LED Driver Maximum Current ⁽⁶⁾	$R_{SET} = 18\text{ k}\Omega$, $\pm 1\%$, $SEL = 0$ $SEL = 1$, Default Setting or 4 Pulses			30 30	mA
I_{LED_OCP}	LED Over Current Protection		32	35	39	mA
Logic Control						
V_{IL}	Logic LOW Threshold				0.68	V
V_{IH}	Logic HIGH Threshold		1.07			V
R_{EN_SEL}	EN, SEL Pull-Down Resistor			280		$\text{k}\Omega$
t_{INIT}	Initialization Time to Engage SEL Pin ⁽³⁾		120			μs
t_{LOW}	Time Period when Pulse is LOW on SEL Pin ⁽³⁾		2	10	25	μs
t_{HIGH}	Time Period when Pulse is HIGH on SEL Pin ⁽³⁾		2	10	25	μs
t_{WINDOW}	Time Window to Count Rising Edges on SEL Pin ⁽³⁾			500		μs
Protection						
T_{TSD}	Over-Temperature Shutdown			150		$^\circ\text{C}$
T_{HYS}	Over-Temperature Hysteresis			25		$^\circ\text{C}$
$t_{SHUTDOWN}$	Shutdown Time		30	33	36	ms
$t_{STARTUP}$	Startup Time			1.2		ms
$V_{OV-RISE}$	V_{OUT} Over-Voltage Rising Threshold			9.0		V
$V_{OV-FALL}$	V_{OUT} Over-Voltage Falling Threshold			8.5		V
V_{OV-HYS}	V_{OUT} Over-Voltage Hysteresis			500		mV
$V_{LED(OCD)}$	LED Open-Circuit Detection Threshold	$2.70\text{ V} \leq V_{IN} \leq 4.35\text{ V}$	8.0	8.3	8.5	V
$V_{LED(SCP)}$	LED Short-Circuit Protection Threshold		0.70	1.00	1.25	V
$I_{LED-SHORT}$	Shorted LED Current	LED Short-Circuit Protection Threshold Tripped			1	μA

Notes:

- In closed-loop operation, the inductor current (I_L) is 100 mA greater than I_{LIM-PK} .
- Guaranteed by characterization and design.
- For the LED outputs, the following are determined: the maximum LED current in the group (MAX), the minimum LED current in the group (MIN), and the average LED current of the group (AVG). Two matching numbers are calculated: $(MAX-AVG)/AVG$ and $(AVG-MIN)/AVG$. The larger number of the two (worst case) is considered the matching value for the group. The matching value for a given part is considered to be the highest matching value of the two groups. The typical specification provided is the most likely norm of the matching value for all parts.
- LED driver drop-out voltage is the smallest voltage across all the LED channels.
- Average LED current across all five (5) outputs.

Typical Characteristics

$V_{IN} = 3.7\text{ V}$, $T_A = +25^\circ\text{C}$, $I_{LED} = 5 \times 28\text{ mA}$, $V_{OUT} = 6.7\text{ V}$, $L_1 = 4.7\ \mu\text{H}$, and $C_{OUT} = 10\ \mu\text{F}$ (unless otherwise specified).

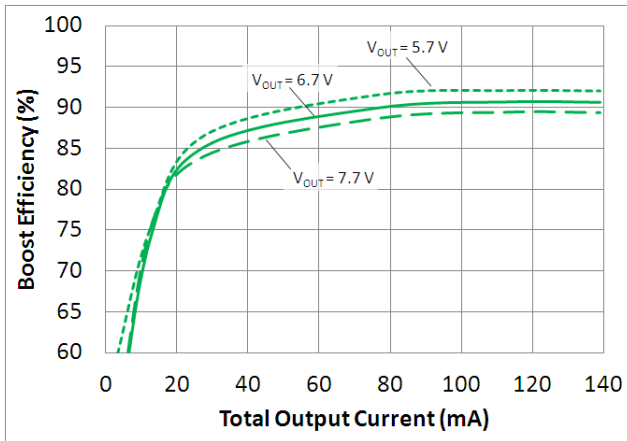

Figure 4. Boost Efficiency vs. Output Current vs. Output Voltage

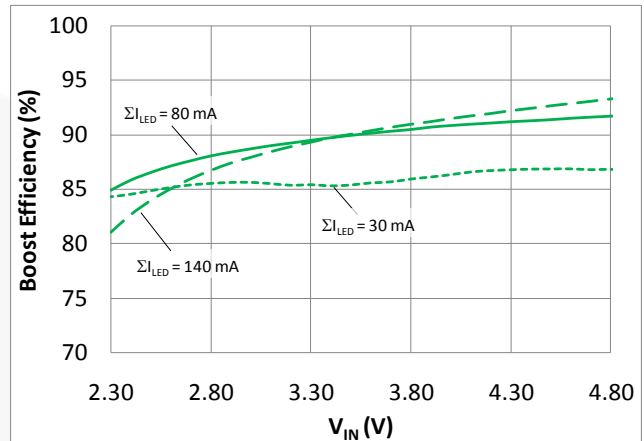

Figure 5. Boost Efficiency vs. Input Voltage vs. Total LED Current

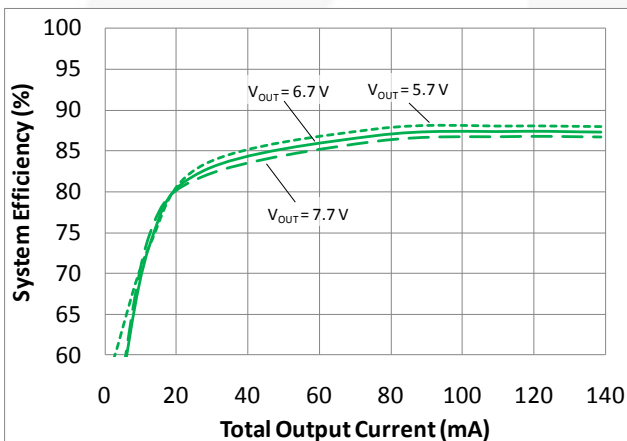

Figure 6. System Efficiency vs. Output Current vs. Output Voltage

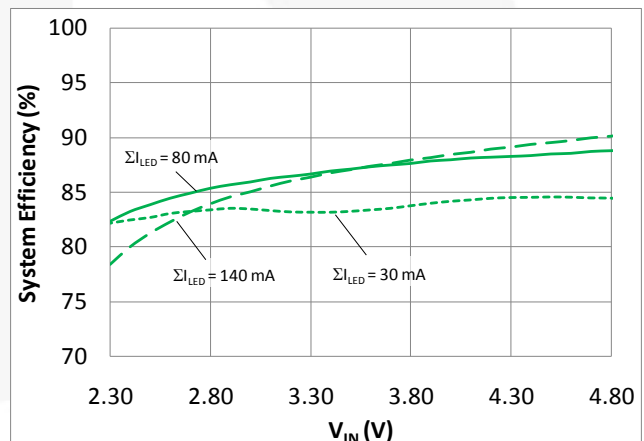

Figure 7. System Efficiency vs. Input Voltage vs. Total LED Current



Figure 8. System Efficiency vs. PWM Duty Cycle, $f_{PWM} = 1\text{ kHz}$

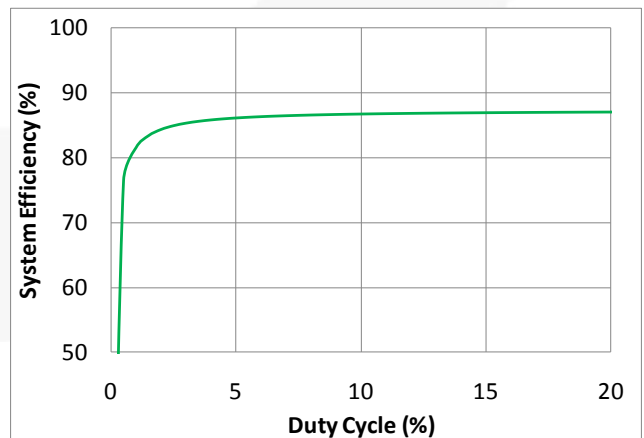

Figure 9. System Efficiency vs. PWM Duty Cycle, $f_{PWM} = 1\text{ kHz}$

Typical Characteristics

$V_{IN} = 3.7\text{ V}$, $T_A = +25^\circ\text{C}$, $I_{LED} = 5 \times 28\text{ mA}$, $V_{OUT} = 6.7\text{ V}$, $L_1 = 4.7\text{ }\mu\text{H}$, and $C_{OUT} = 10\text{ }\mu\text{F}$ (unless otherwise specified).

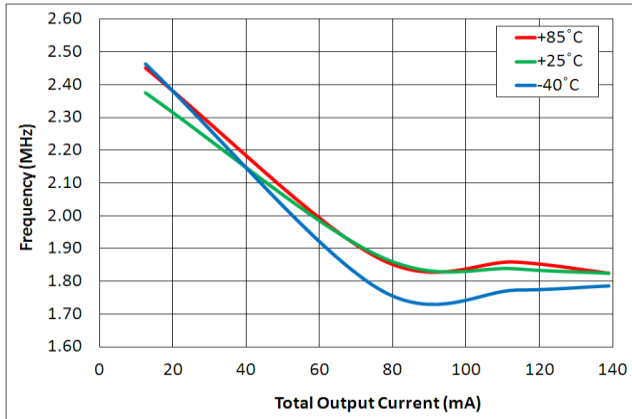

Figure 10. Switching Frequency vs. Total Output Current vs. Temperature



Figure 11. Total LED Current vs. PWM Duty Cycle, $I_{LED} = 5 \times 28\text{ mA}$

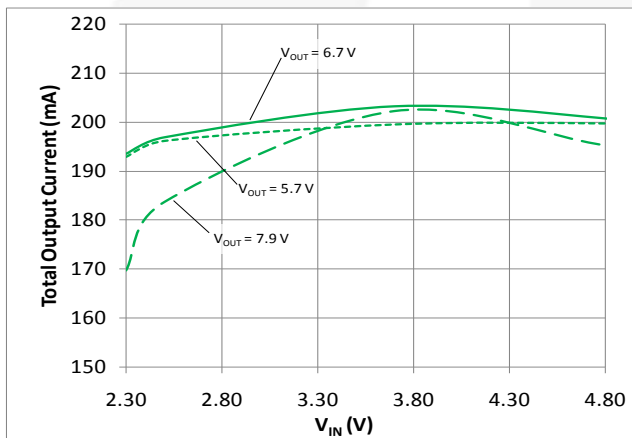

Figure 12. Maximum Output Current vs. Input Voltage vs. Output Voltage

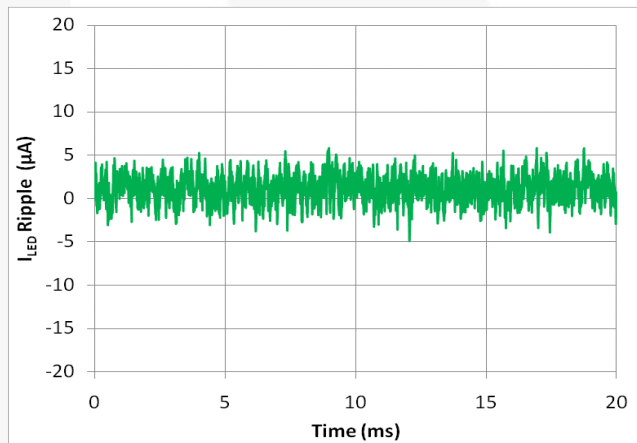

Figure 13. LED Current Ripple, $I_{LED} = 5 \times 28\text{ mA}$, $BW = 500\text{ kHz}$

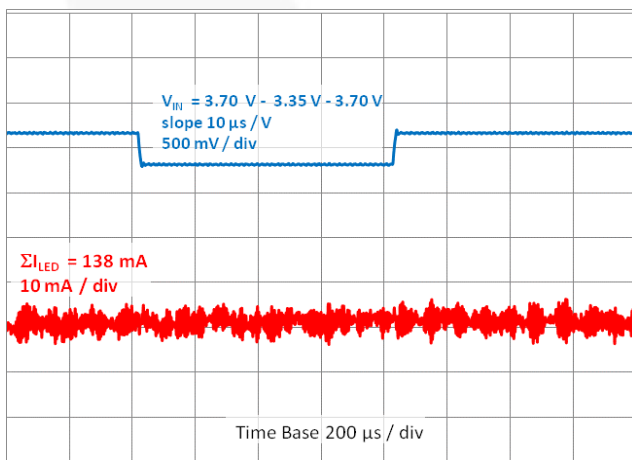

Figure 14. Line Transient Response
 $V_{IN} = 3.70\text{ V} - 3.35\text{ V} - 3.70\text{ V}$, $I_{LED} = 5 \times 28\text{ mA}$

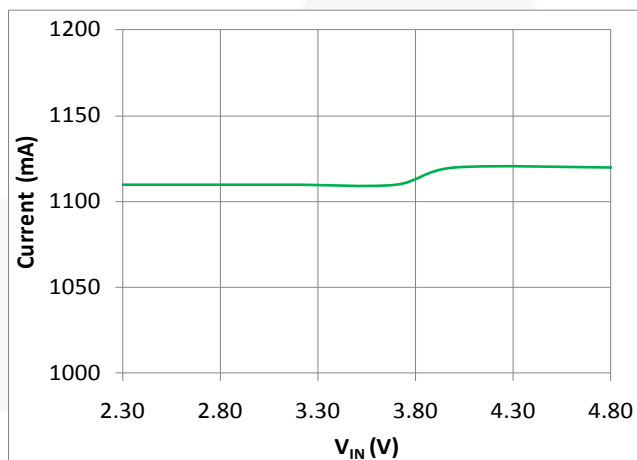

Figure 15. Peak Inductor Current Limit (Closed Loop) vs. Input Voltage

Typical Characteristics

$V_{IN} = 3.7\text{ V}$, $T_A = +25^\circ\text{C}$, $I_{LED} = 5 \times 28\text{ mA}$, $V_{OUT} = 6.7\text{ V}$, $L_1 = 4.7\text{ }\mu\text{H}$, and $C_{OUT} = 10\text{ }\mu\text{F}$ (unless otherwise specified).

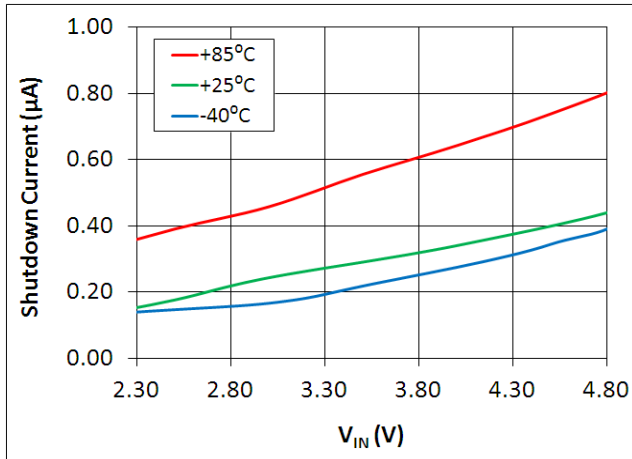

Figure 16. Shutdown Current vs. Input Voltage vs. Temperature

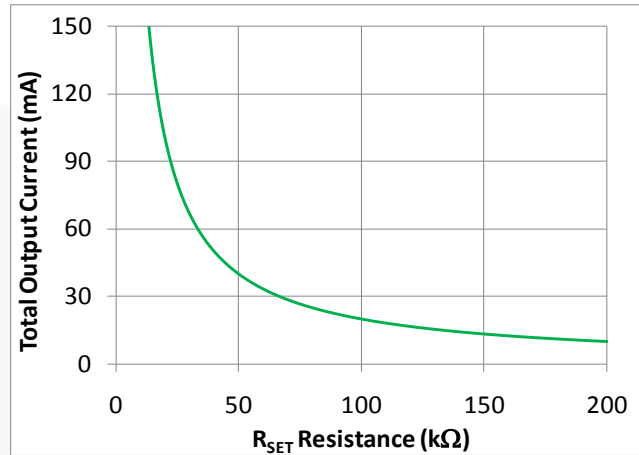

Figure 17. Total Output Current I_{LED} vs. R_{SET} Resistor Value

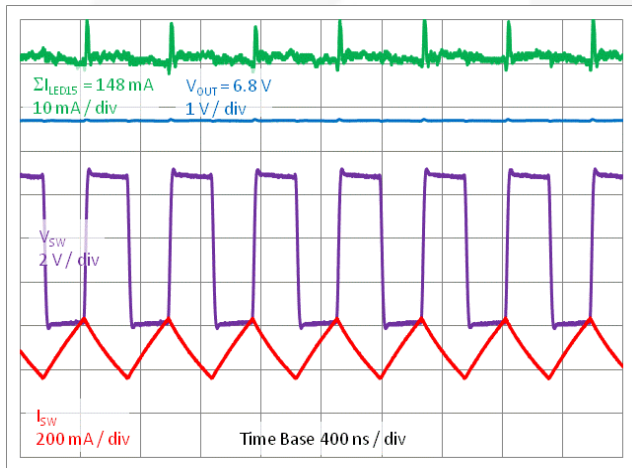

Figure 18. Switch Waveform (V_{OUT} , V_{SW} , I_{SW})

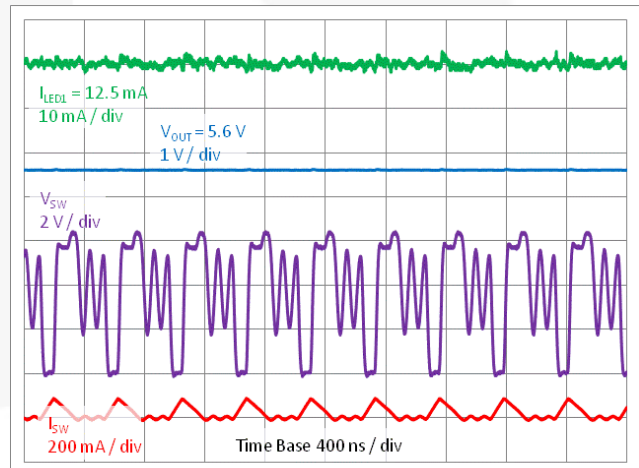

Figure 19. Switch Waveform (V_{OUT} , V_{SW} , I_{SW})

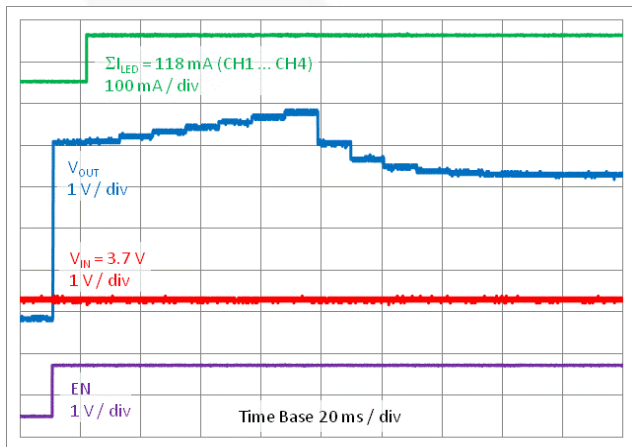

Figure 20. Startup After Enable, Four Strings Connected

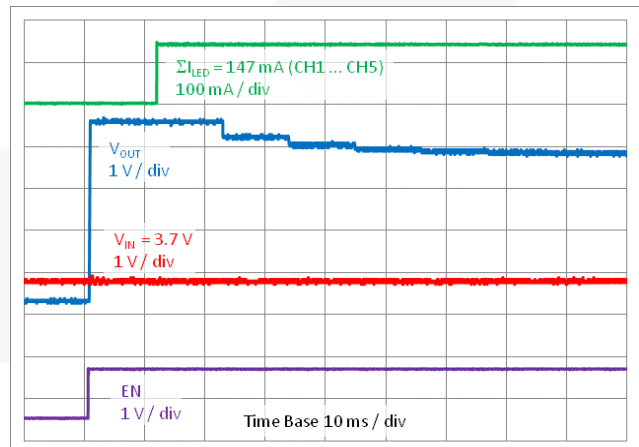

Figure 21. Startup After Enable, Five Strings Connected

Typical Characteristics

$V_{IN} = 3.7\text{ V}$, $T_A = +25^\circ\text{C}$, $I_{LED} = 5 \times 28\text{ mA}$, $V_{OUT} = 6.7\text{ V}$, $L_1 = 4.7\ \mu\text{H}$, and $C_{OUT} = 10\ \mu\text{F}$ (unless otherwise specified).

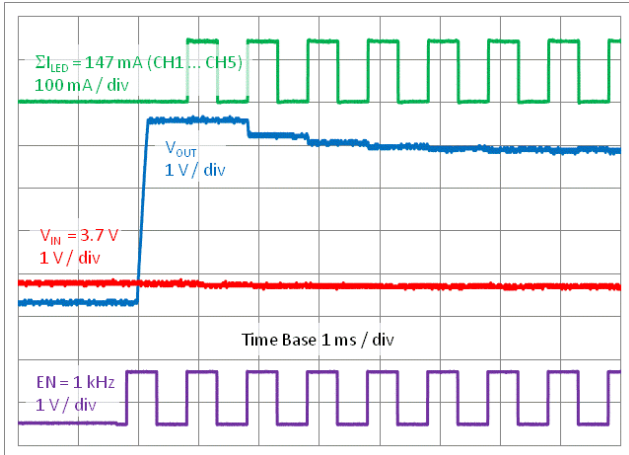

Figure 22. LED PWM Startup, Five Strings Connected

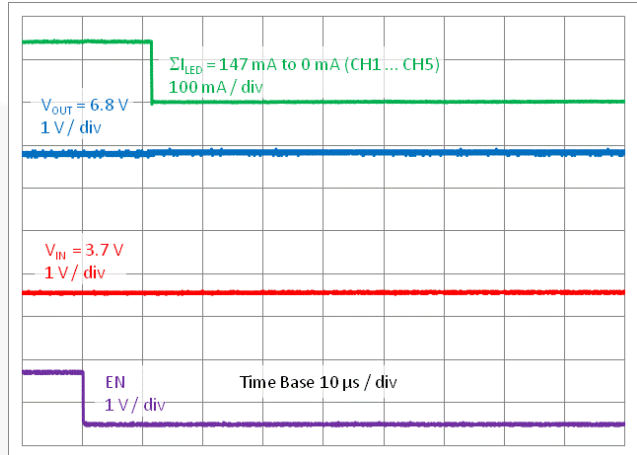

Figure 23. Device Disabled, Five Strings Connected

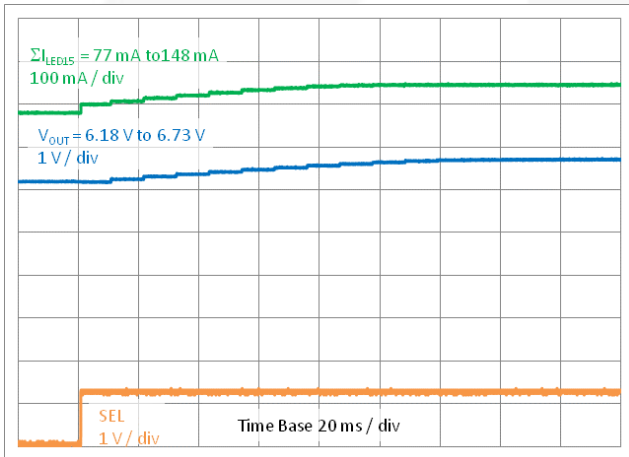

Figure 24. SEL Pin Enabled LED Current Change

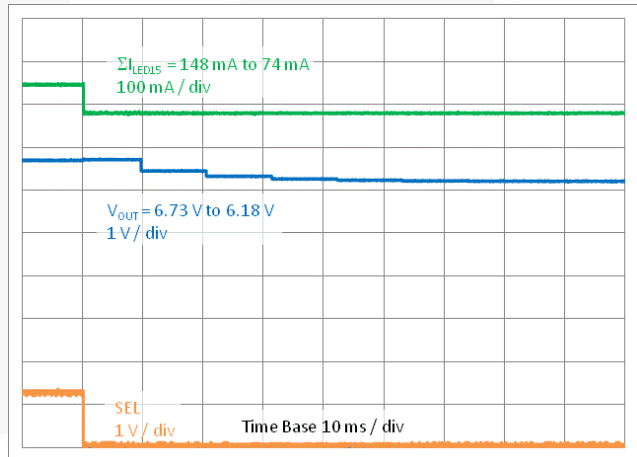

Figure 25. SEL Pin Enabled LED Current Change

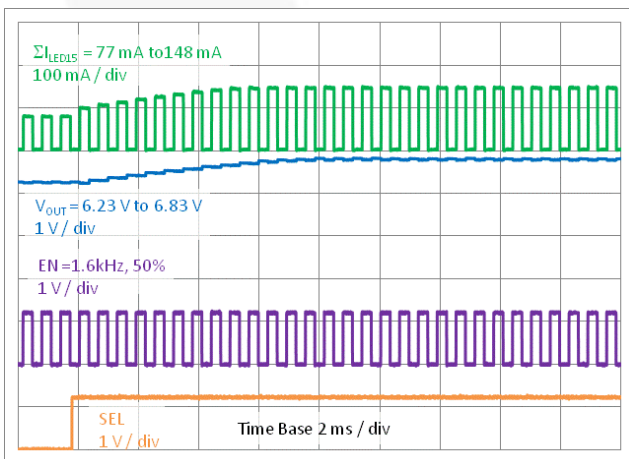

Figure 26. SEL Pin Enabled LED Current Change

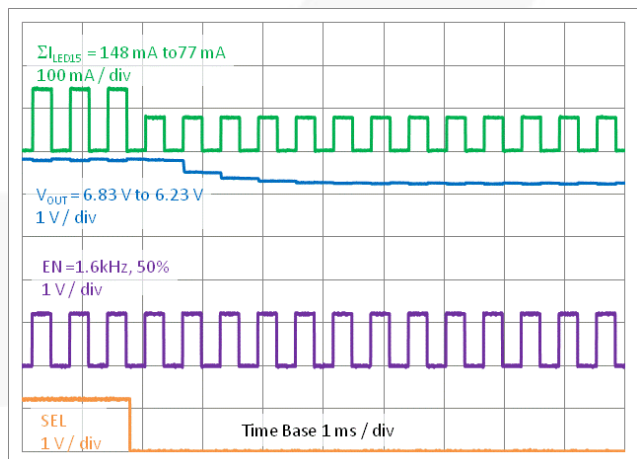

Figure 27. SEL Pin Enabled LED Current Change

Circuit Description

Overview

The FAN5775 is a 1.8 MHz synchronous step-up DC-DC converter with integrated constant-current high-side LED drivers capable of driving one to five LED strings up to five times (5x) 28 mA LED current.

The device starts when at least one LED string is utilized and the EN pin is enabled. The device is disabled 30 ms after setting the EN pin LOW.

The V_{OUT} voltage is internally set to 200 mV above the highest LED string voltage and is sampled at every falling LED PWM cycle. For 100% duty cycle, the LED-pin voltage is sampled and the V_{OUT} voltage is refined every 10 ms.

The LED strings can be disabled by connecting them to V_{OUT} , shorting them to GND, or leaving them disconnected. If the LED string is temporarily disabled or shorted, the device must be restarted to enable the string again.

The LED drivers work independently and allow multiple LED voltages. Therefore, many types of LEDs can be driven at the same time and some strings can be used to drive a single LED while other channels are driving two LEDs in series. The V_{OUT} voltage is defined by the highest LED voltage and the LED driver dropout voltage is increased to provide the LED string a specific voltage. If the voltage difference between the LED strings is large, the system efficiency may decrease.

LED Current

RSET Mode

In RSET Mode, SEL is LOW and the LED string current is set by the resistor, R_{SET} , between the ISET and GND pins. The same current is applied across all strings such that the total output current: $I_{OUT} = 5 \times I_{LED} = 5 \times 20 \text{ mA} = 100 \text{ mA}$ if $R_{SET} = 25 \text{ k}\Omega$ and all LED strings are used. In general, the LED string current can be calculated as follows:

$$I_{LED} = \frac{500}{R_{SET}} \quad (1)$$

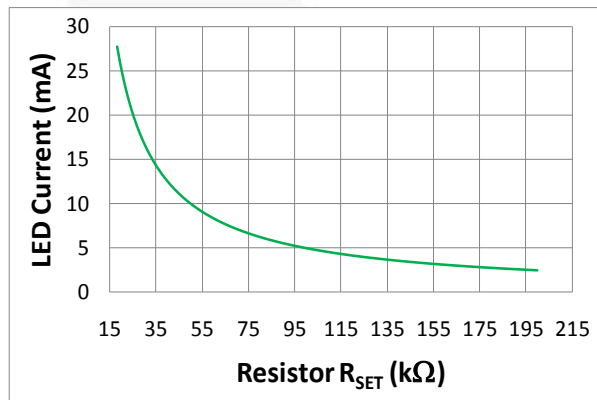

Figure 28. LED Current vs. R_{SET} Value

R_{SET} minimum resistance is internally limited and the device shuts down and requires a new startup if the R_{SET} resistor attempts to set a higher LED current (see the LED Over-Current Protection – section below).

The R_{SET} value is monitored continuously and it can be changed on the fly. If the R_{SET} value is changed, the output current is smoothly changed to a new R_{SET} value. However, there must always be a R_{SET} value within a specified range (18 k Ω to 200 k Ω).

FULL Mode

In FULL Mode, the LED current is determined by a programmable internal resistor. FULL Mode is enabled when SEL is HIGH. The default output LED current for an unprogrammed device is 28 mA. The LED current is set back to R_{SET} defined value (RSET Mode) when SEL pin is LOW.

FULL Mode LED current can be programmed by pulsing the SEL pin. The programmed value is held until the device is reprogrammed or reset by dropping the supply voltage to 0 V. For example, if the device's FULL Mode value is programmed to 27 mA; this is the value of the LED current held by the device when SEL is HIGH. To return to the default value, the device FULL Mode value has to be reprogrammed to 28 mA. Note that the minimum current of 25 mA can be programmed by applying one SEL LOW pulse (1 μ s to 25 μ s). Keep the minimum pulse width longer than 0.1 ms to prevent accidental FULL-value programming.

The FAN5775 has to be active when FULL Mode current is programmed (EN pin is HIGH or LED PWM is applied). The LED current is set accordingly to a programmed (or default) value. The SEL pin has to be HIGH at least for a defined initial time t_{INIT} , after which the programming sequence can be enabled. The device counts all SEL rising edges within a time window, t_{WINDOW} , then adjusts the LED current. The full-scale LED current has a range of 25 mA to 28 mA and is determined by:

- 1 rising edge = 25 mA
- 2 rising edges = 26 mA
- 3 rising edges = 27 mA
- 4 or more rising edges = 28 mA (default value)

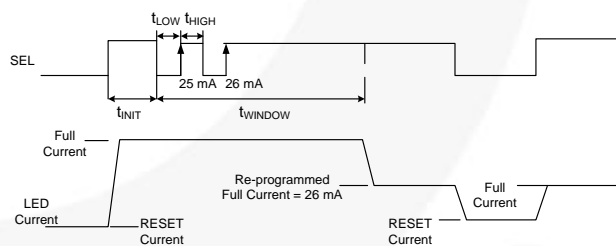

Figure 29. Timing Diagram for SEL Pin (FULL Current Reprogrammed from Default Value of 28 mA to 26 mA)

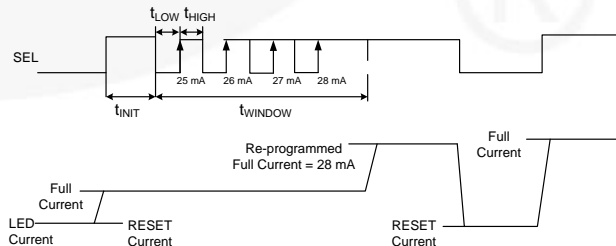

Figure 30. Timing Diagram for SEL Pin (FULL Current is Reprogrammed to 28 mA)

Startup

Setting EN HIGH enables the device and V_{OUT} rises to 7.5 V. The FAN5775 starts to step up or down to the appropriate regulated voltage using its soft-start current limit. LED strings shorted to ground, strings floating, and strings connected to V_{OUT} are disabled at the startup. If all strings are disabled, the device is shut down and it tries to restart at a rising LED PWM or every 10 ms if EN is HIGH.

If V_{OUT} cannot reach 7.5 V within 1.2 ms after an enable cycle, the device attempts to restart.

PWM Dimming

A LED PWM signal of 100 Hz to 1600 Hz can be applied to EN pin to control LED1-5 light intensity. The LED current is a linear function of the LED PWM duty cycle from 100% down to 0.4% or 5 μ s, whichever is greater. The FAN5775 can be started by a PWM signal with a low duty cycle to enable smooth startup. The SEL pin cannot be used for PWM dimming due to long settling time.

Under-Voltage Lockout (UVLO)

The Under-Voltage Lockout circuitry turns off all MOSFETs and the device remains in a very low quiescent current state until V_{IN} rises above the UVLO threshold.

LED Short-Circuit Protection (SCP)

The LED driver is disabled and LED output current is limited to 0.5 μ A when a LED pin voltage is below 1.25 V. This limit shall be applied within one LED PWM cycle, or 10 ms, whichever elapses first. The LED driver enabling requires a device disabling sequence (EN LOW for 33 ms).

If all the LED pin voltages are below 1.25 V (and all channels are thus individually disabled), the device goes into Shutdown Mode and tries to restart at a rising LED PWM or every 10 ms if EN is HIGH.

Over-Voltage Protection (OVP)

When the regulator is active, it monitors the V_{OUT} pin. If the V_{OUT} voltage reaches 9.0 V, the regulator stops switching until the capacitor at V_{OUT} discharges to a level below 8.5 V.

LED-Open Detection

If the V_{LED} channel voltage is detected above 8.30 V, the channel is disabled. The LED driver enabling requires a device disabling sequence (EN LOW for 33 ms).

If all LED pin voltages exceed 8.30 V (and all channels are thus individually disabled), the device goes into Shutdown Mode and tries to restart at a rising LED PWM or every 10 ms if EN is HIGH.

LED Over-Current Protection (OCP)

The LED output current is set either by R_{SET} resistor (when SEL is LOW) or by programmable internal resistor (activated when SEL is HIGH). The R_{SET} value of 15.6 k Ω (~32 mA LED current) or less activates the LED over-current protection and the device is shut down. The device tries to restart at a rising LED PWM or every 10 ms if EN is HIGH.

Inductor Over-Current Protection (ILIM)

The PWM converter is protected against overload through cycle-by-cycle current limit using a fixed internal limit. The device is otherwise working normally – only the maximum inductor current is limited.

Thermal Shutdown

If the die temperature exceeds +150°C, reset occurs and remains in effect until the die cools down to +125°C; at which time, the circuit enters the normal soft-start sequence.

Applications

PCB Layout Guidelines

A separate ground plane is recommended to minimize noise. Place the FAN5775 device, inductor (L₁), C_{IN} and C_{OUT} capacitors, and their interconnections on the same side of the board. High-current paths from the supply voltage to the SW pin via the inductor, and GND pin to ground plane, are recommended as low-resistance paths. Minimize the SW pin capacitance to realize optimum system efficiency. Keep the V_{OUT}-pin-to-C_{OUT} capacitor path as short as possible to minimize the inductance of the V_{OUT}-pin-to-C_{OUT} for low V_{OUT} ripple voltage. Keep the ISET-pin-to-R_{SET} resistor path away from noisy signals (SW pin) to minimize crosstalk from the SW pin to the ISET pin.

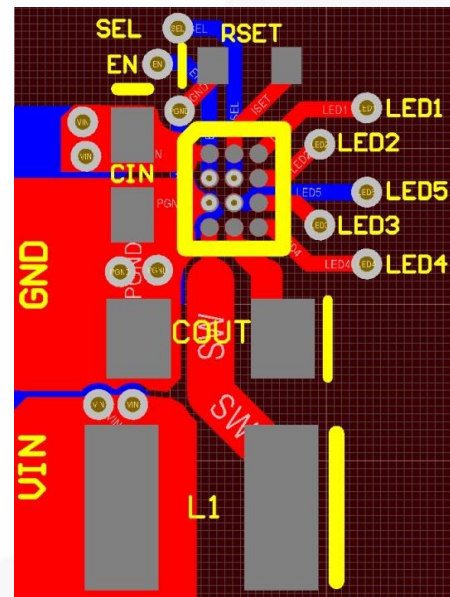

Figure 31. Recommended PCB Layout

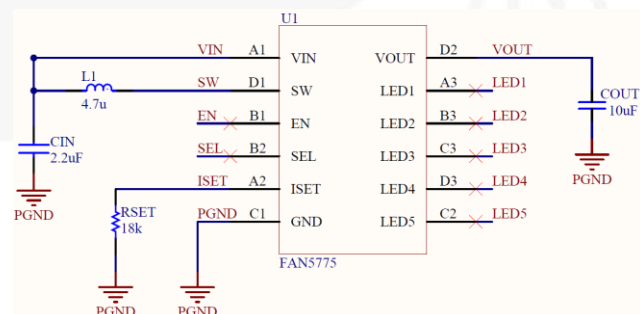

Figure 32. Schematic for Recommended Layout

External Component Selection

Four external components are required to power the FAN5775: an inductor between the VIN and SW pins, a storage capacitor at the output, a storage capacitor at the input, and a reference resistor at the ISET pin.

The inductor's minimum inductance requirement is 1.5 μH with a DCR ≤ 155 mΩ at 1000 mA bias current at 1.8 MHz frequency. A lower inductance drops the efficiency, while a higher inductance reduces the output ripple.

The minimum capacitance for the output capacitor is 4.8 μF at 5 V. Note that the ceramic capacitor value depends on the DC bias voltage. Check the datasheet of the capacitor to make sure the capacitor meets all specifications.

An input capacitor of 2.2 μF is recommended to improve device's transient behavior. Ensure the VIN supply voltage is ripple-free for optimal device performance.

The reference resistor value is ≥ 18 kΩ. The LED current accuracy is defined by this resistor and a high-precision resistor with low temperature dependency is recommended.

Measuring System Efficiency

The system efficiency can be measured using resistors of 49.9 Ω to each of the LED1-5 outputs (see Figure 33 for the set-up of this measurement). The resistors are tied together and connected to a DC voltage source (VSINK) with a volt meter in parallel. DC voltage sources are for VIN and VEN. Once this set-up is ready and set with values stated in Figure 33; measure VIN, IIN, VLED1 to VLED5, VSINK, and ISINK. Calculate the system efficiency with Equation 2. LED voltages are not exactly the same, so each must be measured separately.

The system efficiency (ηSYSTEM) is calculated as follows:

$$\eta_{SYSTEM} = \sum_{i=1}^5 \frac{I_i V_i}{I_{IN} V_{IN}} \quad (2)$$

where I_i is LED(i) channel current; V_i is LED(i) channel voltage; I_{IN} is supply current (rms); V_{IN} is supply voltage (rms). LED current I_i is calculated on calibrated LED string resistors R_i = 49.9 Ω + ΔR_i, where i = 1 to 5.

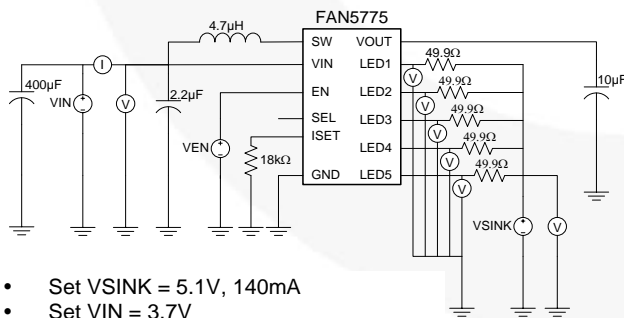

- Set VSINK = 5.1V, 140mA
- Set VIN = 3.7V
- Set VEN = 1.2V
- Measure VIN, IIN, VLED1...5, and VSINK
- Calculate efficiency

Figure 33. Circuit Diagram to Measure System Efficiency

Flashlight Example

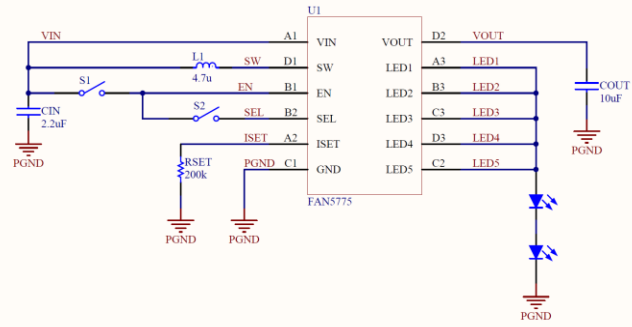

Figure 34. Schematic for Flashlight Applications

To use the FAN5775 as a LED flashlight driver, as shown in Figure 34, connect VIN to the battery voltage and add a single-pole switch S1 (either mechanical or electrical) from EN to VIN. Pull-down resistors on the EN pins disable the device when the switch is in a non-conducting state. The SEL pin can be connected to VIN voltage by switch S2 for higher output current. In the example above, SEL LOW current is 5 x 2.5 mA = 12.5 mA while SEL HIGH current is 5 x 28 mA = 140 mA (default). The SEL pin can be connected to ground.

RSET Value Change Example

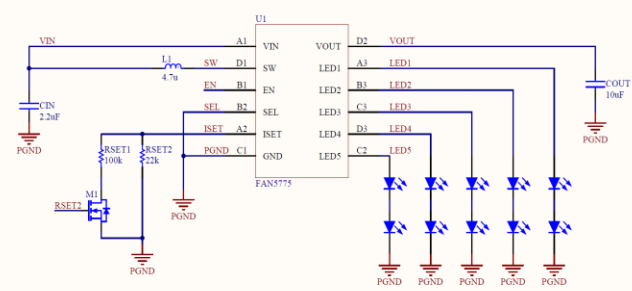

Figure 35. Schematic for RSET Change Example

The output current can be changed on-the-fly by switching another resistor (RSET1 in Figure 35) in parallel to RSET2 and the output current changes accordingly (RSET2 = 22 kΩ → 22.7 mA LED channel current and RSET1 || RSET2 = 18 kΩ → 27.7 mA LED channel current). Select a low-capacitance switch to keep the output current clean – this is especially important if PWM control is applied on the EN pin.

Physical Dimensions

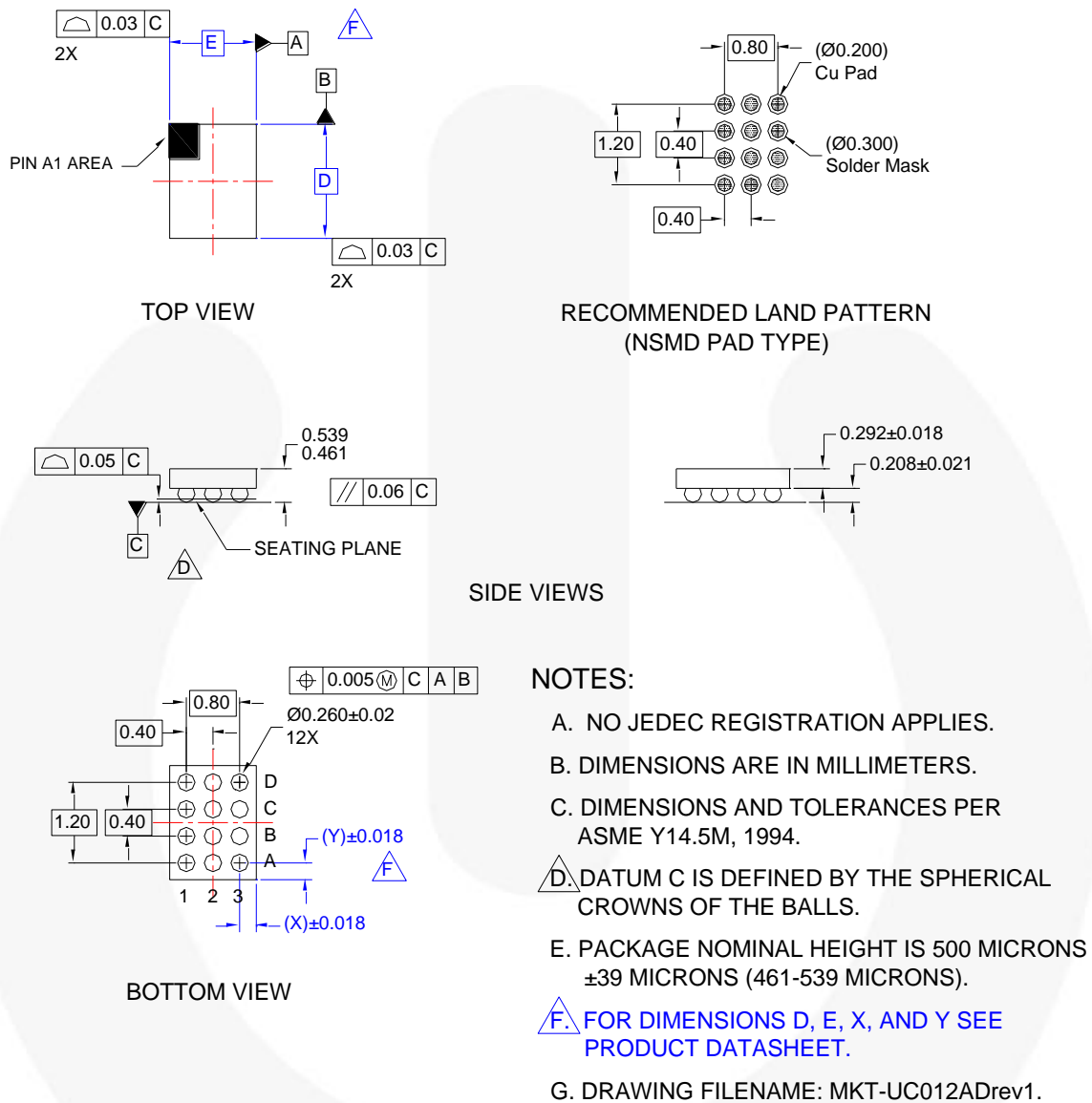

Figure 36. 12-Bump, Wafer-Level Chip-Scale Package (WLCSP) 1.41 x 1.80 x 0.50 mm, 0.40 mm Pitch

Product-Specific Dimensions

Product	D	E	X	Y
FAN5775UCX	1.800 mm	1.410 mm	0.305 mm	0.300 mm





Package drawings are provided as a service to customers considering Fairchild components. Drawings may change in any manner without notice. Please note the revision and/or date on the drawing and contact a Fairchild Semiconductor representative to verify or obtain the most recent revision. Package specifications do not expand the terms of Fairchild's worldwide terms and conditions, specifically the warranty therein, which covers Fairchild products.

Always visit Fairchild Semiconductor's online packaging area for the most recent package drawings:
<http://www.fairchildsemi.com/dwg/UC/UC012AD.pdf>.

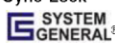

TRADEMARKS

The following includes registered and unregistered trademarks and service marks, owned by Fairchild Semiconductor and/or its global subsidiaries, and is not intended to be an exhaustive list of all such trademarks.

- | | | | |
|--|--|---|---|
| AccuPower™ | F-PFS™ |  | Sync-Lock™ |
| AX-CAP®* | FRFET® | PowerXS™ |  SYSTEM GENERAL® |
| BitSiC™ | Global Power Resource™ | PowerTrench® | TinyBoost® |
| Build it Now™ | GreenBridge™ | PowerXS™ | TinyBuck® |
| CorePLUS™ | Green FPS™ | Programmable Active Droop™ | TinyCalc™ |
| CorePOWER™ | Green FPS™ e-Series™ | QFET® | TinyLogic™ |
| CROSSVOLT™ | Gmax™ | QS™ | TINYOPTO™ |
| CTL™ | GTO™ | Quiet Series™ | TinyPower™ |
| Current Transfer Logic™ | IntelliMAX™ | RapidConfigure™ | TinyPWM™ |
| DEUXPEED® | ISOPLANAR™ |  Saving our world, 1mW/W/kW at a time™ | TinyWire™ |
| Dual Cool™ | Making Small Speakers Sound Louder and Better™ | SignalWise™ | TransiC™ |
| EcoSPARK® | MegaBuck™ | SmartMax™ | TriFault Detect™ |
| EfficientMax™ | MICROCOUPLER™ | SMART START™ | TRUECURRENT®* |
| ESBC™ | MicroFET™ | Solutions for Your Success™ | µSerDes™ |
|  Fairchild® | MicroPak™ | SPM® |  SerDes® |
| Fairchild Semiconductor® | MicroPak2™ | STEALTH™ | UHC® |
| FACT Quiet Series™ | MillerDrive™ | SuperFET® | Ultra FRFET™ |
| FACT® | MotionMax™ | SuperSOT™-3 | UniFET™ |
| FAST® | mWSaver® | SuperSOT™-6 | VCX™ |
| FastvCore™ | OptoHiT™ | SuperSOT™-8 | VisualMax™ |
| FETBench™ | OPTOLOGIC® | SupreMOS® | VoltagePlus™ |
| FPS™ | OPTOPLANAR® | SyncFET™ | XSTM |

* Trademarks of System General Corporation, used under license by Fairchild Semiconductor.

DISCLAIMER

FAIRCHILD SEMICONDUCTOR RESERVES THE RIGHT TO MAKE CHANGES WITHOUT FURTHER NOTICE TO ANY PRODUCTS HEREIN TO IMPROVE RELIABILITY, FUNCTION, OR DESIGN. FAIRCHILD DOES NOT ASSUME ANY LIABILITY ARISING OUT OF THE APPLICATION OR USE OF ANY PRODUCT OR CIRCUIT DESCRIBED HEREIN; NEITHER DOES IT CONVEY ANY LICENSE UNDER ITS PATENT RIGHTS, NOR THE RIGHTS OF OTHERS. THESE SPECIFICATIONS DO NOT EXPAND THE TERMS OF FAIRCHILD'S WORLDWIDE TERMS AND CONDITIONS, SPECIFICALLY THE WARRANTY THEREIN, WHICH COVERS THESE PRODUCTS.

LIFE SUPPORT POLICY

FAIRCHILD'S PRODUCTS ARE NOT AUTHORIZED FOR USE AS CRITICAL COMPONENTS IN LIFE SUPPORT DEVICES OR SYSTEMS WITHOUT THE EXPRESS WRITTEN APPROVAL OF FAIRCHILD SEMICONDUCTOR CORPORATION.

As used herein:

1. Life support devices or systems are devices or systems which, (a) are intended for surgical implant into the body or (b) support or sustain life, and (c) whose failure to perform when properly used in accordance with instructions for use provided in the labeling, can be reasonably expected to result in a significant injury of the user.
2. A critical component in any component of a life support, device, or system whose failure to perform can be reasonably expected to cause the failure of the life support device or system, or to affect its safety or effectiveness.

ANTI-COUNTERFEITING POLICY

Fairchild Semiconductor Corporation's Anti-Counterfeiting Policy. Fairchild's Anti-Counterfeiting Policy is also stated on our external website, www.fairchildsemi.com, under Sales Support.

Counterfeiting of semiconductor parts is a growing problem in the industry. All manufacturers of semiconductor products are experiencing counterfeiting of their parts. Customers who inadvertently purchase counterfeit parts experience many problems such as loss of brand reputation, substandard performance, failed applications, and increased cost of production and manufacturing delays. Fairchild is taking strong measures to protect ourselves and our customers from the proliferation of counterfeit parts. Fairchild strongly encourages customers to purchase Fairchild parts either directly from Fairchild or from Authorized Fairchild Distributors who are listed by country on our web page cited above. Products customers buy either from Fairchild directly or from Authorized Fairchild Distributors are genuine parts, have full traceability, meet Fairchild's quality standards for handling and storage and provide access to Fairchild's full range of up-to-date technical and product information. Fairchild and our Authorized Distributors will stand behind all warranties and will appropriately address any warranty issues that may arise. Fairchild will not provide any warranty coverage or other assistance for parts bought from Unauthorized Sources. Fairchild is committed to combat this global problem and encourage our customers to do their part in stopping this practice by buying direct or from authorized distributors.

PRODUCT STATUS DEFINITIONS

Definition of Terms

Datasheet Identification	Product Status	Definition
Advance Information	Formative / In Design	Datasheet contains the design specifications for product development. Specifications may change in any manner without notice.
Preliminary	First Production	Datasheet contains preliminary data; supplementary data will be published at a later date. Fairchild Semiconductor reserves the right to make changes at any time without notice to improve design.
No Identification Needed	Full Production	Datasheet contains final specifications. Fairchild Semiconductor reserves the right to make changes at any time without notice to improve the design.
Obsolete	Not In Production	Datasheet contains specifications on a product that is discontinued by Fairchild Semiconductor. The datasheet is for reference information only.

Rev. 166