

MC74AC08, MC74ACT08

Quad 2-Input AND Gate

Features

- Outputs Source/Sink 24 mA
- 'ACT08 Has TTL Compatible Inputs
- Pb-Free Packages are Available

MAXIMUM RATINGS

Rating	Symbol	Value	Unit
DC Supply Voltage (Referenced to GND)	V_{CC}	-0.5 to +7.0	V
DC Input Voltage (Referenced to GND)	V_{in}	-0.5 to $V_{CC} + 0.5$	V
DC Output Voltage (Referenced to GND)	V_{out}	-0.5 to $V_{CC} + 0.5$	V
DC Input Current, per Pin	I_{in}	± 20	mA
DC Output Sink/Source Current, per Pin	I_{out}	± 50	mA
DC V_{CC} or GND Current per Output Pin	I_{CC}	± 50	mA
Storage Temperature	T_{stg}	-65 to +150	$^{\circ}C$

Stresses exceeding Maximum Ratings may damage the device. Maximum Ratings are stress ratings only. Functional operation above the Recommended Operating Conditions is not implied. Extended exposure to stresses above the Recommended Operating Conditions may affect device reliability.

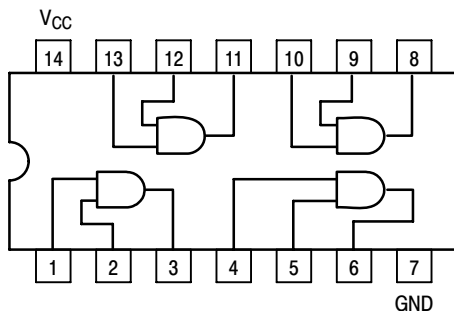
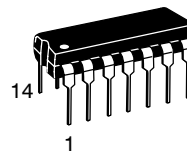

Figure 1. Pinout: 14-Lead Packages Conductors
(Top View)



ON Semiconductor[®]

<http://onsemi.com>



PDIP-14
N SUFFIX
CASE 646

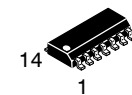

SO-14
D SUFFIX
CASE 751A



TSSOP-14
DT SUFFIX
CASE 948G

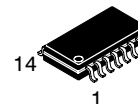

SOEIAJ-14
M SUFFIX
CASE 965

ORDERING INFORMATION

See detailed ordering and shipping information in the package dimensions section on page 5 of this data sheet.

DEVICE MARKING INFORMATION

See general marking information in the device marking section on page 5 of this data sheet.

MC74AC08, MC74ACT08

RECOMMENDED OPERATING CONDITIONS

Symbol	Parameter	Min	Typ	Max	Unit	
V _{CC}	Supply Voltage	'AC	2.0	5.0	6.0	V
		'ACT	4.5	5.0	5.5	
V _{in} , V _{out}	DC Input Voltage, Output Voltage (Ref. to GND)	0	-	V _{CC}	V	
t _r , t _f	Input Rise and Fall Time (Note 1) 'AC Devices except Schmitt Inputs	V _{CC} @ 3.0 V	-	150	-	ns/V
		V _{CC} @ 4.5 V	-	40	-	
		V _{CC} @ 5.5 V	-	25	-	
t _r , t _f	Input Rise and Fall Time (Note 2) 'ACT Devices except Schmitt Inputs	V _{CC} @ 4.5 V	-	10	-	ns/V
		V _{CC} @ 5.5 V	-	8.0	-	
T _J	Junction Temperature (PDIP)	-	-	140	°C	
T _A	Operating Ambient Temperature Range	-40	25	85	°C	
I _{OH}	Output Current – High	-	-	-24	mA	
I _{OL}	Output Current – Low	-	-	24	mA	

- V_{in} from 30% to 70% V_{CC}; see individual Data Sheets for devices that differ from the typical input rise and fall times.
- V_{in} from 0.8 V to 2.0 V; see individual Data Sheets for devices that differ from the typical input rise and fall times.

DC CHARACTERISTICS

Symbol	Parameter	Conditions	V _{CC} (V)	74AC		74AC		Unit	
				T _A = +25°C		T _A = -40°C to +85°C			
				Typ	Guaranteed Limits				
V _{IH}	Minimum High Level Input Voltage	V _{OUT} = 0.1 V or V _{CC} - 0.1 V	3.0	1.5	2.1	2.1	V		
			4.5	2.25	3.15	3.15			
			5.5	2.75	3.85	3.85			
V _{IL}	Maximum Low Level Input Voltage	V _{OUT} = 0.1 V or V _{CC} - 0.1 V	3.0	1.5	0.9	0.9	V		
			4.5	2.25	1.35	1.35			
			5.5	2.75	1.65	1.65			
V _{OH}	Minimum High Level Output Voltage	I _{OUT} = -50 μA	3.0	2.99	2.9	2.9	V		
			4.5	4.49	4.4	4.4			
			5.5	5.49	5.4	5.4			
		V _{IN} = V _{IL} or V _{IH} (Note 3)	I _{OH}	-12 mA	3.0	-	2.56	2.46	V
				-24 mA	4.5	-	3.86	3.76	
V _{OL}	Maximum Low Level Output Voltage	V _{IN} = V _{IL} or V _{IH} (Note 3)	12 mA	3.0	-	0.36	0.44	V	
			I _{OL} 24 mA	4.5	-	0.36	0.44		
			I _{OL} 24 mA	5.5	-	0.36	0.44		
I _{IN}	Maximum Input Leakage Current	V _I = V _{CC} , GND	5.5	-	±0.1	±1.0	μA		
I _{OLD}	Minimum Dynamic (Note 4) Output Current	V _{OLD} = 1.65 V Max	5.5	-	-	75	mA		
I _{OHD}		V _{OHD} = 3.85 V Min	5.5	-	-	-75	mA		
I _{CC}	Maximum Quiescent Supply Current	V _{IN} = V _{CC} or GND	5.5	-	4.0	40	μA		

NOTE: I_{IN} and I_{CC} @ 3.0 V are guaranteed to be less than or equal to the respective limit @ 5.5 V V_{CC}.

3. All outputs loaded; thresholds on input associated with output under test.

4. Maximum test duration 2.0 ms, one output loaded at a time.

MC74AC08, MC74ACT08

AC CHARACTERISTICS (For Figures and Waveforms – See Section 3 of the ON Semiconductor FACT Data Book, DL138/D)

Symbol	Parameter	V _{CC} (V) (Note 5)	74AC			74AC		Unit	Fig. No.
			T _A = +25°C C _L = 50 pF			T _A = -40°C to +85°C C _L = 50 pF			
			Min	Typ	Max	Min	Max		
t _{PLH}	Propagation Delay	3.3 5.0	1.5 1.5	7.5 5.5	9.5 7.5	1.0 1.0	10.0 8.5	ns	3-5
t _{PHL}	Propagation Delay	3.3 5.0	1.5 1.5	7.0 5.5	8.5 7.0	1.0 1.0	9.0 7.5	ns	3-5

5. Voltage Range 3.3 V is 3.3 V ±0.3 V.
Voltage Range 5.0 V is 5.0 V ±0.5 V.

DC CHARACTERISTICS

Symbol	Parameter	Conditions	V _{CC} (V)	74ACT		74ACT		Unit
				T _A = +25°C		T _A = -40°C to +85°C		
				Typ	Guaranteed Limits			
V _{IH}	Minimum High Level Input Voltage	V _{OUT} = 0.1 V or V _{CC} - 0.1 V	4.5	1.5	2.0	2.0	V	
			5.5	1.5	2.0	2.0		
V _{IL}	Maximum Low Level Input Voltage	V _{OUT} = 0.1 V or V _{CC} - 0.1 V	4.5	1.5	0.8	0.8	V	
			5.5	1.5	0.8	0.8		
V _{OH}	Minimum High Level Output Voltage	I _{OUT} = -50 μA	4.5	4.49	4.4	4.4	V	
			5.5	5.49	5.4	5.4		
		V _{IN} = V _{IL} or V _{IH} (Note 6)	-24 mA	4.5	-	3.86	3.76	V
			-24 mA	5.5	-	4.86	4.76	
V _{OL}	Maximum Low Level Output Voltage	I _{OUT} = 50 μA	4.5	0.001	0.1	0.1	V	
			5.5	0.001	0.1	0.1		
		V _{IN} = V _{IL} or V _{IH} (Note 6)	24 mA	4.5	-	0.36	0.44	V
			24 mA	5.5	-	0.36	0.44	
I _{IN}	Maximum Input Leakage Current	V _I = V _{CC} , GND	5.5	-	±0.1	±1.0	μA	
ΔI _{CCT}	Additional Max. I _{CC} /Input	V _I = V _{CC} - 2.1 V	5.5	0.6	-	1.5	mA	
I _{OLD}	Minimum Dynamic (Note 7) Output Current	V _{OLD} = 1.65 V Max	5.5	-	-	75	mA	
I _{OHD}		V _{OHD} = 3.85 V Min	5.5	-	-	-75	mA	
I _{CC}	Maximum Quiescent Supply Current	V _{IN} = V _{CC} or GND	5.5	-	4.0	40	μA	

6. All outputs loaded; thresholds on input associated with output under test.
7. Maximum test duration 2.0 ms, one output loaded at a time.

MC74AC08, MC74ACT08

AC CHARACTERISTICS (For Figures and Waveforms – See Section 3 of the ON Semiconductor FACT Data Book, DL138/D)

Symbol	Parameter	V _{CC} (V) (Note 8)	74ACT			74ACT		Unit	Fig. No.
			T _A = +25°C C _L = 50 pF			T _A = -40°C to +85°C C _L = 50 pF			
			Min	Typ	Max	Min	Max		
t _{PLH}	Propagation Delay	5.0	1.0	–	9.0	1.0	10.0	ns	3–5
t _{PHL}	Propagation Delay	5.0	1.0	–	9.0	1.0	10.0	ns	3–5

8. Voltage Range 5.0 V is 5.0 V ±0.5 V.

CAPACITANCE

Symbol	Parameter	Test Conditions	Value Typ	Unit
C _{IN}	Input Capacitance	V _{CC} = 5.0 V	4.5	pF
C _{PD}	Power Dissipation Capacitance	V _{CC} = 5.0 V	20	pF

MC74AC08, MC74ACT08

MARKING DIAGRAMS

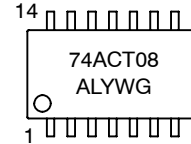
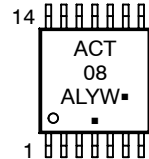
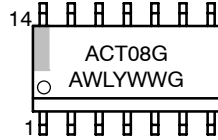
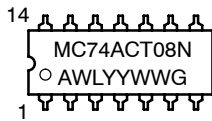
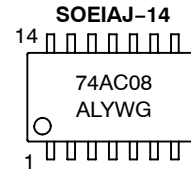
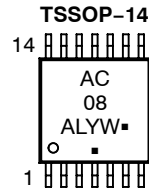
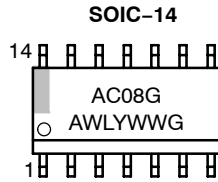
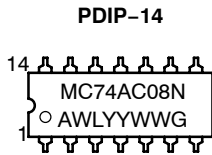

A = Assembly Location
 WL, L = Wafer Lot
 YY, Y = Year
 WW, W = Work Week
 G or ■ = Pb-free Package
 (Note: Microdot may be in either location)

ORDERING INFORMATION

Device	Package	Shipping†
MC74AC08N	PDIP-14	25 Units / Rail
MC74AC08NG	PDIP-14 (Pb-Free)	
MC74AC08D	SOIC-14	55 Units / Rail
MC74AC08DG	SOIC-14 (Pb-Free)	
MC74AC08DR2	SOIC-14	2500 / Tape & Reel
MC74AC08DR2G	SOIC-14 (Pb-Free)	
MC74AC08DTR2	TSSOP-14*	
MC74AC08DTR2G	TSSOP-14*	
MC74AC08MEL	SOEIAJ-14	2000 / Tape & Reel
MC74AC08MELG	SOEIAJ-14 (Pb-Free)	
MC74ACT08N	PDIP-14	25 Units / Rail
MC74ACT08NG	PDIP-14 (Pb-Free)	
MC74ACT08D	SOIC-14	55 Units / Rail
MC74ACT08DG	SOIC-14 (Pb-Free)	
MC74ACT08DR2	SOIC-14	2500 / Tape & Reel
MC74ACT08DR2G	SOIC-14 (Pb-Free)	
MC74ACT08DTR2	TSSOP-14*	
MC74ACT08DTR2G	TSSOP-14*	
MC74ACT08MEL	SOEIAJ-14	2000 / Tape & Reel
MC74ACT08MELG	SOEIAJ-14 (Pb-Free)	

†For information on tape and reel specifications, including part orientation and tape sizes, please refer to our Tape and Reel Packaging Specifications Brochure, BRD8011/D.

*This package is inherently Pb-Free.

MC74AC08, MC74ACT08

PACKAGE DIMENSIONS

PDIP-14
CASE 646-06
ISSUE P

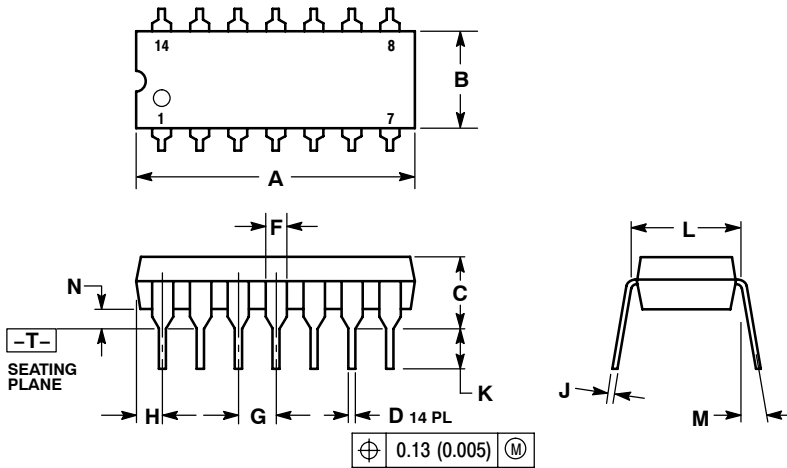

NOTES:

1. DIMENSIONING AND TOLERANCING PER ANSI Y14.5M, 1982.
2. CONTROLLING DIMENSION: INCH.
3. DIMENSION L TO CENTER OF LEADS WHEN FORMED PARALLEL.
4. DIMENSION B DOES NOT INCLUDE MOLD FLASH.
5. ROUNDED CORNERS OPTIONAL.

DIM	INCHES		MILLIMETERS	
	MIN	MAX	MIN	MAX
A	0.715	0.770	18.16	19.56
B	0.240	0.260	6.10	6.60
C	0.145	0.185	3.69	4.69
D	0.015	0.021	0.38	0.53
F	0.040	0.070	1.02	1.78
G	0.100 BSC		2.54 BSC	
H	0.052	0.095	1.32	2.41
J	0.008	0.015	0.20	0.38
K	0.115	0.135	2.92	3.43
L	0.290	0.310	7.37	7.87
M	---	10°	---	10°
N	0.015	0.039	0.38	1.01

MC74AC08, MC74ACT08

PACKAGE DIMENSIONS

SOIC-14
CASE 751A-03
ISSUE H



NOTES:

1. DIMENSIONING AND TOLERANCING PER ANSI Y14.5M, 1982.
2. CONTROLLING DIMENSION: MILLIMETER.
3. DIMENSIONS A AND B DO NOT INCLUDE MOLD PROTRUSION.
4. MAXIMUM MOLD PROTRUSION 0.15 (0.006) PER SIDE.
5. DIMENSION D DOES NOT INCLUDE DAMBAR PROTRUSION. ALLOWABLE DAMBAR PROTRUSION SHALL BE 0.127 (0.005) TOTAL IN EXCESS OF THE D DIMENSION AT MAXIMUM MATERIAL CONDITION.

DIM	MILLIMETERS		INCHES	
	MIN	MAX	MIN	MAX
A	8.55	8.75	0.337	0.344
B	3.80	4.00	0.150	0.157
C	1.35	1.75	0.054	0.068
D	0.35	0.49	0.014	0.019
F	0.40	1.25	0.016	0.049
G	1.27 BSC		0.050 BSC	
J	0.19	0.25	0.008	0.009
K	0.10	0.25	0.004	0.009
M	0°	7°	0°	7°
P	5.80	6.20	0.228	0.244
R	0.25	0.50	0.010	0.019

SOLDERING FOOTPRINT*

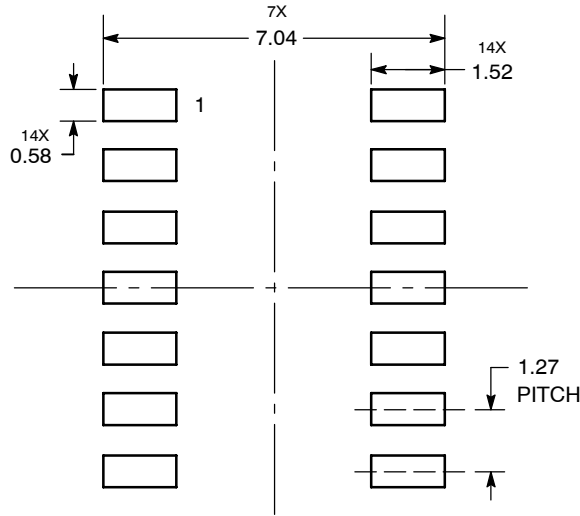

DIMENSIONS: MILLIMETERS

*For additional information on our Pb-Free strategy and soldering details, please download the ON Semiconductor Soldering and Mounting Techniques Reference Manual, SOLDERRM/D.

MC74AC08, MC74ACT08

PACKAGE DIMENSIONS

TSSOP-14
CASE 948G-01
ISSUE B

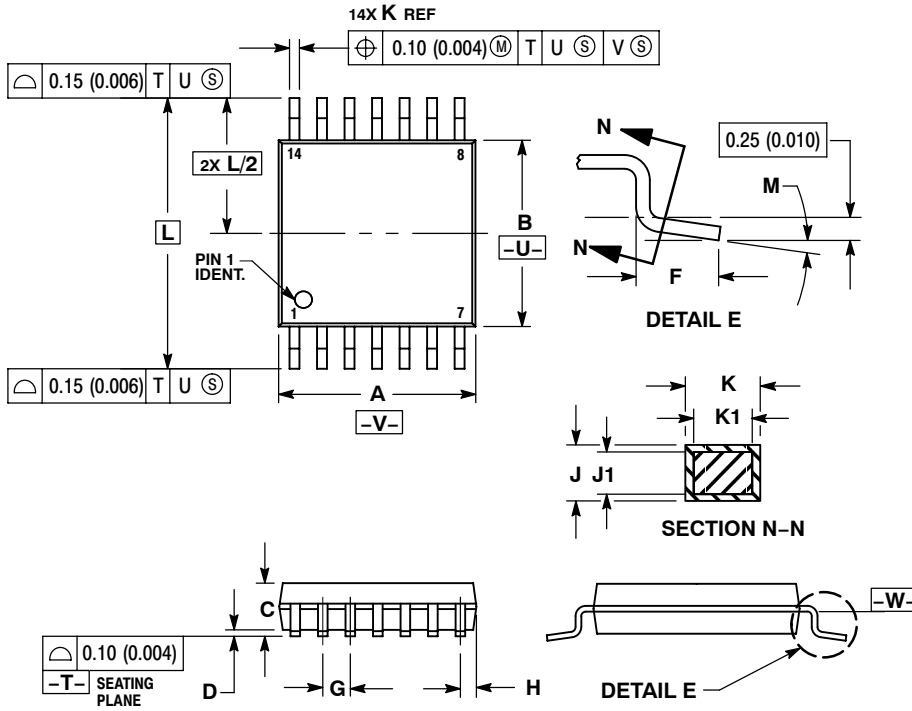

- NOTES:
1. DIMENSIONING AND TOLERANCING PER ANSI Y14.5M, 1982.
 2. CONTROLLING DIMENSION: MILLIMETER.
 3. DIMENSION A DOES NOT INCLUDE MOLD FLASH, PROTRUSIONS OR GATE BURRS. MOLD FLASH OR GATE BURRS SHALL NOT EXCEED 0.15 (0.006) PER SIDE.
 4. DIMENSION B DOES NOT INCLUDE INTERLEAD FLASH OR PROTRUSION. INTERLEAD FLASH OR PROTRUSION SHALL NOT EXCEED 0.25 (0.010) PER SIDE.
 5. DIMENSION K DOES NOT INCLUDE DAMBAR PROTRUSION. ALLOWABLE DAMBAR PROTRUSION SHALL BE 0.08 (0.003) TOTAL IN EXCESS OF THE K DIMENSION AT MAXIMUM MATERIAL CONDITION.
 6. TERMINAL NUMBERS ARE SHOWN FOR REFERENCE ONLY.
 7. DIMENSION A AND B ARE TO BE DETERMINED AT DATUM PLANE -W-.

DIM	MILLIMETERS		INCHES	
	MIN	MAX	MIN	MAX
A	4.90	5.10	0.193	0.200
B	4.30	4.50	0.169	0.177
C	---	1.20	---	0.047
D	0.05	0.15	0.002	0.006
F	0.50	0.75	0.020	0.030
G	0.65 BSC		0.026 BSC	
H	0.50	0.60	0.020	0.024
J	0.09	0.20	0.004	0.008
J1	0.09	0.16	0.004	0.006
K	0.19	0.30	0.007	0.012
K1	0.19	0.25	0.007	0.010
L	6.40 BSC		0.252 BSC	
M	0° 8°		0° 8°	

SOLDERING FOOTPRINT*



*For additional information on our Pb-Free strategy and soldering details, please download the ON Semiconductor Soldering and Mounting Techniques Reference Manual, SOLDERRM/D.

MC74AC08, MC74ACT08

PACKAGE DIMENSIONS

SOEIAJ-14
CASE 965-01
ISSUE A



NOTES:

1. DIMENSIONING AND TOLERANCING PER ANSI Y14.5M, 1982.
2. CONTROLLING DIMENSION: MILLIMETER.
3. DIMENSIONS D AND E DO NOT INCLUDE MOLD FLASH OR PROTRUSIONS AND ARE MEASURED AT THE PARTING LINE. MOLD FLASH OR PROTRUSIONS SHALL NOT EXCEED 0.15 (0.006) PER SIDE.
4. TERMINAL NUMBERS ARE SHOWN FOR REFERENCE ONLY.
5. THE LEAD WIDTH DIMENSION (b) DOES NOT INCLUDE DAMBAR PROTRUSION. ALLOWABLE DAMBAR PROTRUSION SHALL BE 0.08 (0.003) TOTAL IN EXCESS OF THE LEAD WIDTH DIMENSION AT MAXIMUM MATERIAL CONDITION. DAMBAR CANNOT BE LOCATED ON THE LOWER RADIUS OR THE FOOT. MINIMUM SPACE BETWEEN PROTRUSIONS AND ADJACENT LEAD TO BE 0.46 (0.018).

DIM	MILLIMETERS		INCHES	
	MIN	MAX	MIN	MAX
A	---	2.05	---	0.081
A ₁	0.05	0.20	0.002	0.008
b	0.35	0.50	0.014	0.020
c	0.10	0.20	0.004	0.008
D	9.90	10.50	0.390	0.413
E	5.10	5.45	0.201	0.215
e	1.27 BSC		0.050 BSC	
HE	7.40	8.20	0.291	0.323
0.50	0.50	0.85	0.020	0.033
LE	1.10	1.50	0.043	0.059
M	0°	10°	0°	10°
Q ₁	0.70	0.90	0.028	0.035
Z	---	1.42	---	0.056

ON Semiconductor and are registered trademarks of Semiconductor Components Industries, LLC (SCILLC). SCILLC reserves the right to make changes without further notice to any products herein. SCILLC makes no warranty, representation or guarantee regarding the suitability of its products for any particular purpose, nor does SCILLC assume any liability arising out of the application or use of any product or circuit, and specifically disclaims any and all liability, including without limitation special, consequential or incidental damages. "Typical" parameters which may be provided in SCILLC data sheets and/or specifications can and do vary in different applications and actual performance may vary over time. All operating parameters, including "Typicals" must be validated for each customer application by customer's technical experts. SCILLC does not convey any license under its patent rights nor the rights of others. SCILLC products are not designed, intended, or authorized for use as components in systems intended for surgical implant into the body, or other applications intended to support or sustain life, or for any other application in which the failure of the SCILLC product could create a situation where personal injury or death may occur. Should Buyer purchase or use SCILLC products for any such unintended or unauthorized application, Buyer shall indemnify and hold SCILLC and its officers, employees, subsidiaries, affiliates, and distributors harmless against all claims, costs, damages, and expenses, and reasonable attorney fees arising out of, directly or indirectly, any claim of personal injury or death associated with such unintended or unauthorized use, even if such claim alleges that SCILLC was negligent regarding the design or manufacture of the part. SCILLC is an Equal Opportunity/Affirmative Action Employer. This literature is subject to all applicable copyright laws and is not for resale in any manner.

PUBLICATION ORDERING INFORMATION

LITERATURE FULFILLMENT:
Literature Distribution Center for ON Semiconductor
P.O. Box 5163, Denver, Colorado 80217 USA
Phone: 303-675-2175 or 800-344-3860 Toll Free USA/Canada
Fax: 303-675-2176 or 800-344-3867 Toll Free USA/Canada
Email: orderlit@onsemi.com

N. American Technical Support: 800-282-9855 Toll Free
USA/Canada
Europe, Middle East and Africa Technical Support:
Phone: 421 33 790 2910
Japan Customer Focus Center
Phone: 81-3-5773-3850

ON Semiconductor Website: www.onsemi.com
Order Literature: <http://www.onsemi.com/orderlit>

For additional information, please contact your local Sales Representative