

# KA258/KA258A, KA358/KA358A, KA2904

## Dual Operational Amplifier

### Features

- Internally Frequency Compensated for Unity Gain
- Large DC Voltage Gain: 100dB
- Wide Power Supply Range:  
KA258/KA258A, KA358/KA358A: 3V ~ 32V (or  $\pm 1.5V \sim 16V$ )  
KA2904 : 3V~26V (or  $\pm 1.5V \sim 13V$ )
- Input Common Mode Voltage Range Includes Ground
- Large Output Voltage Swing: 0V DC to  $V_{CC} - 1.5V$  DC
- Power Drain Suitable for Battery Operation.

### Description

The KA258 series consist of two independent, high gain, internally frequency compensated operational amplifiers which were designed specifically to operate from a single power supply over a wide range of voltage. Operation from split power supplies is also possible and the low power supply current drain is independent of the magnitude of the power supply voltage. Application areas include transducer amplifier, DC gain blocks and all the conventional OP-AMP circuits which now can be easily implemented in single power supply systems.

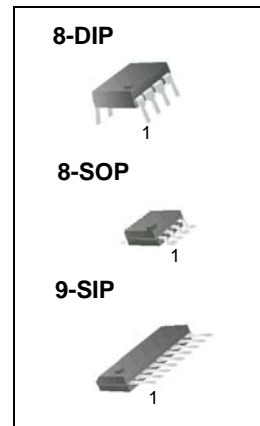

### Internal Block Diagram

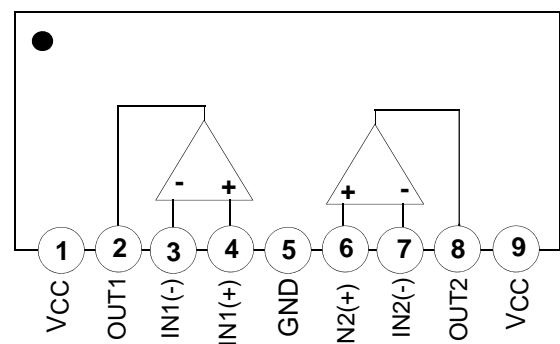
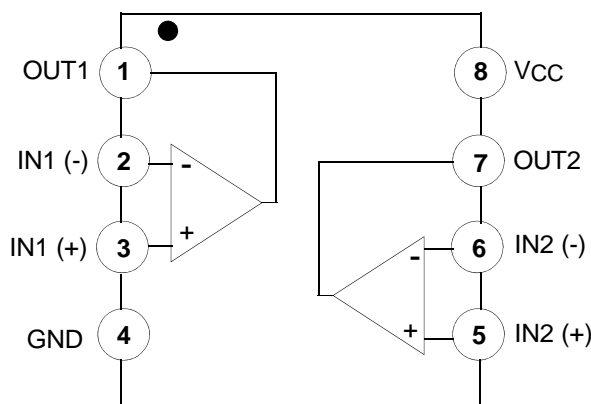

## Schematic Diagram

(One section only)

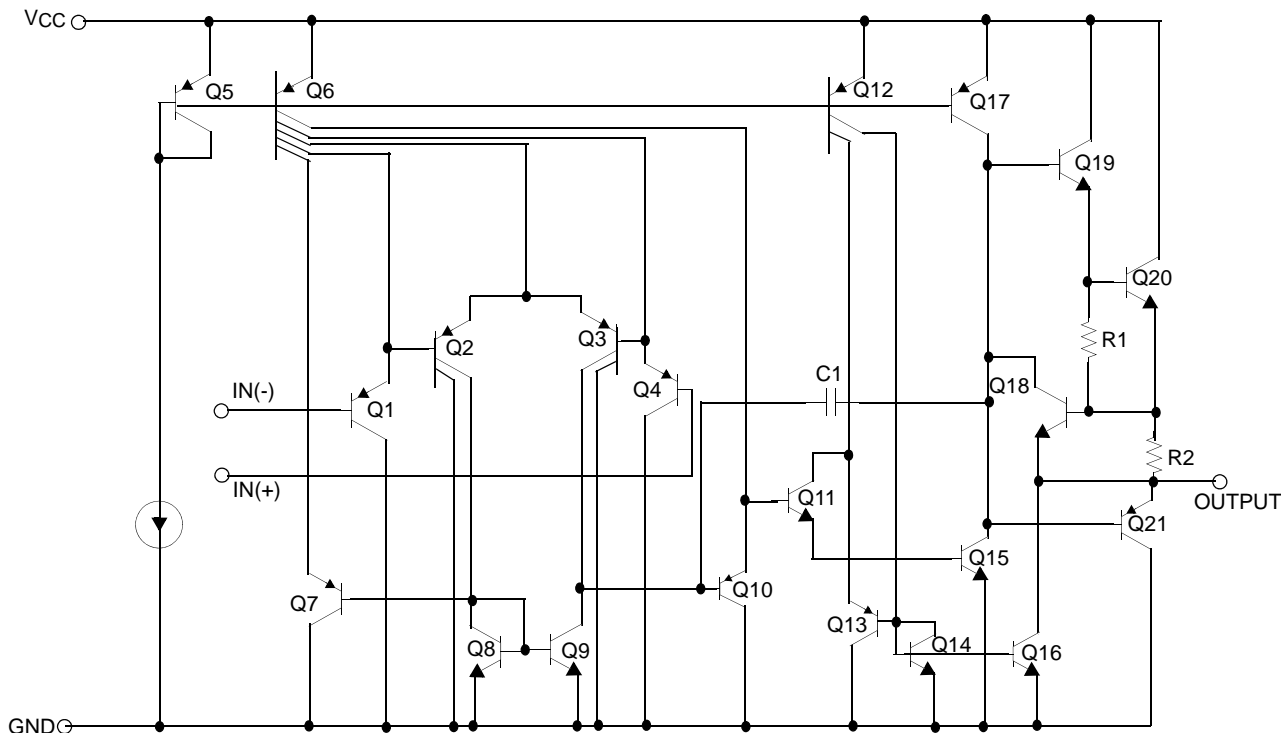

## Absolute Maximum Ratings

Parameter	Symbol	KA258/KA258A	KA358/KA358A	KA2904	Unit
Supply Voltage	VCC	±16 or 32	±16 or 32	±13 or 26	V
Differential Input Voltage	VI(DIFF)	32	32	26	V
Input Voltage	VI	-0.3 to +32	-0.3 to +32	-0.3 to +26	V
Output Short Circuit to GND VCC ≤ 15V, TA = 25°C (One Amp)	-	Continuous	Continuous	Continuous	-
Operating Temperature Range	TOPR	-25 ~ +85	0 ~ +70	-40 ~ +85	°C
Maximum Junction Temperature	TJ(MAX)	+150	+150	+150	°C
Storage Temperature Range	TSTG	-65 ~ +150	-65 ~ +150	-65 ~ +150	°C

## Electrical Characteristics

( $V_{CC} = 5.0V$ ,  $V_{EE} = GND$ ,  $T_A = 25^\circ C$ , unless otherwise specified)

Parameter	Symbol	Conditions	KA258			KA358			KA2904			Unit
			Min.	Typ.	Max.	Min.	Typ.	Max.	Min.	Typ.	Max.	
Input Offset Voltage	$V_{IO}$	$V_{CM} = 0V$ to $V_{CC} - 1.5V$ $V_{O(P)} = 1.4V$ , $R_S = 0\Omega$	-	2.9	5.0	-	2.9	7.0	-	2.9	7.0	mV
Input Offset Current	$I_{IO}$	-	-	3	30	-	5	50	-	5	50	nA
Input Bias Current	$I_{BIAS}$	-	-	45	150	-	45	250	-	45	250	nA
Input Voltage Range	$V_{I(R)}$	$V_{CC} = 30V$ (KA2904, $V_{CC} = 26V$ )	0	-	$V_{CC} - 1.5$	0	-	$V_{CC} - 1.5$	0	-	$V_{CC} - 1.5$	V
Supply Current	$I_{CC}$	$R_L = \infty$ , $V_{CC} = 30V$ (KA2904, $V_{CC} = 26V$ )	-	0.8	2.0	-	0.8	2.0	-	0.8	2.0	mA
		$R_L = \infty$ , $V_{CC} = 5V$	-	0.5	1.2	-	0.5	1.2	-	0.5	1.2	mA
Large Signal Voltage Gain	$G_V$	$V_{CC} = 15V$ , $R_L = 2k\Omega$ $V_{O(P)} = 1V$ to $11V$	50	100	-	25	100	-	25	100	-	V/mV
Output Voltage Swing	$V_{O(H)}$	$V_{CC} = 30V$ , $R_L = 2k\Omega$	26	-	-	26	-	-	22	-	-	V
		( $V_{CC} = 26V$ for KA2904)	27	28	-	27	28	-	23	24	-	V
	$V_{O(L)}$	$V_{CC} = 5V$ , $R_L = 10k\Omega$	-	5	20	-	5	20	-	5	20	mV
Common-Mode Rejection Ratio	CMRR	-	70	85	-	65	80	-	50	80	-	dB
Power Supply Rejection Ratio	PSRR	-	65	100	-	65	100	-	50	100	-	dB
Channel Separation	CS	$f = 1kHz$ to $20kHz$ (Note1)	-	120	-	-	120	-	-	120	-	dB
Short Circuit to GND	$I_{SC}$	-	-	40	60	-	40	60	-	40	60	mA
Output Current	ISOURCE	$V_{I(+)} = 1V$ , $V_{I(-)} = 0V$ $V_{CC} = 15V$ , $V_{O(P)} = 2V$	20	30	-	20	30	-	20	30	-	mA
	ISINK	$V_{I(+)} = 0V$ , $V_{I(-)} = 1V$ $V_{CC} = 15V$ , $V_{O(P)} = 2V$	10	15	-	10	15	-	10	15	-	mA
		$V_{I(+)} = 0V$ , $V_{I(-)} = 1V$ $V_{CC} = 15V$ , $V_{O(P)} = 200mV$	12	100	-	12	100	-	-	-	-	$\mu A$
Differential Input Voltage	$V_{I(DIFF)}$	-	-	$V_{CC}$	-	-	$V_{CC}$	-	-	$V_{CC}$	V	

### Note:

1. This parameter, although guaranteed, is not 100% tested in production.

**Electrical Characteristics** (Continued)(V<sub>CC</sub> = 5.0V, V<sub>EE</sub> = GND, unless otherwise specified)The following specification apply over the range of -25°C ≤ T<sub>A</sub> ≤ +85°C for the KA258; and the 0°C ≤ T<sub>A</sub> ≤ +70°C for the KA358; and the -40°C ≤ T<sub>A</sub> ≤ +85°C for the KA2904

Parameter	Symbol	Conditions	KA258			KA358			KA2904			Unit	
			Min.	Typ.	Max.	Min.	Typ.	Max.	Min.	Typ.	Max.		
Input Offset Voltage	V <sub>IO</sub>	V <sub>CM</sub> = 0V to V <sub>CC</sub> -1.5V V <sub>O(P)</sub> = 1.4V, R <sub>S</sub> = 0Ω	-	-	7.0	-	-	9.0	-	-	10.0	mV	
Input Offset Voltage Drift	ΔV <sub>IO</sub> /ΔT	R <sub>S</sub> = 0Ω	-	7.0	-	-	7.0	-	-	7.0	-	μV/°C	
Input Offset Current	I <sub>IO</sub>	-	-	-	100	-	-	150	-	45	200	nA	
Input Offset Current Drift	ΔI <sub>IO</sub> /ΔT	-	-	10	-	-	10	-	-	10	-	pA/°C	
Input Bias Current	I <sub>BIAS</sub>	-	-	40	300	-	40	500	-	40	500	nA	
Input Voltage Range	V <sub>I(R)</sub>	V <sub>CC</sub> = 30V (KA2904, V <sub>CC</sub> = 26V)	0	-	V <sub>CC</sub> -2.0	0	-	V <sub>CC</sub> -2.0	0	-	V <sub>CC</sub> -2.0	V	
Large Signal Voltage Gain	G <sub>V</sub>	V <sub>CC</sub> = 15V, R <sub>L</sub> = 2.0kΩ V <sub>O(P)</sub> = 1V to 11V	25	-	-	15	-	-	15	-	-	V/mV	
Output Voltage Swing	V <sub>O(H)</sub>	V <sub>CC</sub> = 30V (V <sub>CC</sub> = 26V for KA2904)	R <sub>L</sub> = 2kΩ	26	-	-	26	-	-	22	-	-	V
			R <sub>L</sub> = 10kΩ	27	28	-	27	28	-	23	24	-	V
	V <sub>O(L)</sub>	V <sub>CC</sub> = 5V, R <sub>L</sub> = 10kΩ	-	5	20	-	5	20	-	5	20	mV	
Output Current	I <sub>SOURCE</sub>	V <sub>I(+)</sub> = 1V, V <sub>I(-)</sub> = 0V V <sub>CC</sub> = 15V, V <sub>O(P)</sub> = 2V	10	30	-	10	30	-	10	30	-	mA	
	I <sub>SINK</sub>	V <sub>I(+)</sub> = 0V, V <sub>I(-)</sub> = 1V V <sub>CC</sub> = 15V, V <sub>O(P)</sub> = 2V	5	8	-	5	9	-	5	9	-	mA	
Differential Input Voltage	V <sub>I(DIFF)</sub>	-	-	-	V <sub>CC</sub>	-	-	V <sub>CC</sub>	-	-	V <sub>CC</sub>	V	

**Electrical Characteristics** (Continued)(V<sub>CC</sub> = 5.0V, V<sub>EE</sub> = GND, T<sub>A</sub> = 25°C, unless otherwise specified)

Parameter	Symbol	Conditions	KA258A			KA358A			Unit
			Min.	Typ.	Max.	Min.	Typ.	Max.	
Input Offset Voltage	V <sub>IO</sub>	V <sub>CM</sub> = 0V to V <sub>CC</sub> -1.5V V <sub>O(P)</sub> = 1.4V, R <sub>S</sub> = 0Ω	-	1.0	3.0	-	2.0	3.0	mV
Input Offset Current	I <sub>IO</sub>	-	-	2	15	-	5	30	nA
Input Bias Current	I <sub>BIAS</sub>	-	-	40	80	-	45	100	nA
Input Voltage Range	V <sub>I(R)</sub>	V <sub>CC</sub> = 30V	0	-	V <sub>CC</sub> -1.5	0	-	V <sub>CC</sub> -1.5	V
Supply Current	I <sub>CC</sub>	R <sub>L</sub> = ∞, V <sub>CC</sub> = 30V	-	0.8	2.0	-	0.8	2.0	mA
		R <sub>L</sub> = ∞, V <sub>CC</sub> = 5V	-	0.5	1.2	-	0.5	1.2	mA
Large Signal Voltage Gain	G <sub>V</sub>	V <sub>CC</sub> = 15V, R <sub>L</sub> = 2kΩ V <sub>O</sub> = 1V to 11V	50	100	-	25	100	-	V/mV
Output Voltage Swing	V <sub>OH</sub>	V <sub>CC</sub> = 30V	R <sub>L</sub> = 2kΩ	26	-	-	26	-	V
			R <sub>L</sub> = 10kΩ	27	28	-	27	28	-
	V <sub>O(L)</sub>	V <sub>CC</sub> = 5V, R <sub>L</sub> = 10kΩ	-	5	20	-	5	20	mV
Common-Mode Rejection Ratio	CMRR	-	70	85	-	65	85	-	dB
Power Supply Rejection Ratio	PSRR	-	65	100	-	65	100	-	dB
Channel Separation	CS	f = 1kHz to 20kHz (Note1)	-	120	-	-	120	-	dB
Short Circuit to GND	I <sub>SC</sub>	-	-	40	60	-	40	60	mA
Output Current	I <sub>SOURCE</sub>	V <sub>I(+)</sub> = 1V, V <sub>I(-)</sub> = 0V V <sub>CC</sub> = 15V, V <sub>O(P)</sub> = 2V	20	30	-	20	30	-	mA
	I <sub>SINK</sub>	V <sub>I(+)</sub> = 1V, V <sub>I(-)</sub> = 0V V <sub>CC</sub> = 15V, V <sub>O(P)</sub> = 2V	10	15	-	10	15	-	mA
		V <sub>in(+)</sub> = 0V, V <sub>in(-)</sub> = 1V V <sub>O(P)</sub> = 200mV	12	100	-	12	100	-	μA
Differential Input Voltage	V <sub>I(DIFF)</sub>	-	-	-	V <sub>CC</sub>	-	-	V <sub>CC</sub>	V

**Note:**

1. This parameter, although guaranteed, is not 100% tested in production.

**Electrical Characteristics** (Continued)(V<sub>CC</sub> = 5.0V, V<sub>EE</sub> = GND, unless otherwise specified)The following specification apply over the range of -25°C ≤ T<sub>A</sub> ≤ +85°C for the KA258A; and the 0°C ≤ T<sub>A</sub> ≤ +70°C for the KA358A

Parameter	Symbol	Conditions	KA258A			KA358A			Unit	
			Min.	Typ.	Max.	Min.	Typ.	Max.		
Input Offset Voltage	V <sub>IO</sub>	V <sub>CM</sub> = 0V to V <sub>CC</sub> -1.5V V <sub>O(P)</sub> = 1.4V, R <sub>S</sub> = 0Ω	-	-	4.0	-	-	5.0	mV	
Input Offset Voltage Drift	ΔV <sub>IO</sub> /ΔT	-	-	7.0	15	-	7.0	20	μV/°C	
Input Offset Current	I <sub>IO</sub>	-	-	-	30	-	-	75	nA	
Input Offset Current Drift	ΔI <sub>IO</sub> /ΔT	-	-	10	200	-	10	300	pA/°C	
Input Bias Current	I <sub>BIAS</sub>	-	-	40	100	-	40	200	nA	
Input Common-Mode Voltage Range	V <sub>I(R)</sub>	V <sub>CC</sub> = 30V	0	-	V <sub>CC</sub> -2.0	0	-	V <sub>CC</sub> -2.0	V	
Output Voltage Swing	V <sub>O(H)</sub>	V <sub>CC</sub> = 30V	R <sub>L</sub> = 2kΩ	26	-	-	26	-	-	V
			R <sub>L</sub> = 10kΩ	27	28	-	27	28	-	V
	V <sub>O(L)</sub>	V <sub>CC</sub> = 5V, R <sub>L</sub> = 10kΩ	-	5	20	-	5	20	mV	
Large Signal Voltage Gain	G <sub>V</sub>	V <sub>CC</sub> = 15V, R <sub>L</sub> = 2.0kΩ V <sub>O(P)</sub> = 1V to 11V	25	-	-	15	-	-	V/mV	
Output Current	I <sub>SOURCE</sub>	V <sub>I(+)</sub> = 1V, V <sub>I(-)</sub> = 0V V <sub>CC</sub> = 15V, V <sub>O(P)</sub> = 2V	10	30	-	10	30	-	mA	
	I <sub>SINK</sub>	V <sub>I(+)</sub> = 1V, V <sub>I(-)</sub> = 0V V <sub>CC</sub> = 15V, V <sub>O(P)</sub> = 2V	5	9	-	5	9	-	mA	
Differential Input Voltage	V <sub>I(DIFF)</sub>	-	-	-	V <sub>CC</sub>	-	-	V <sub>CC</sub>	V	

# Typical Performance Characteristics

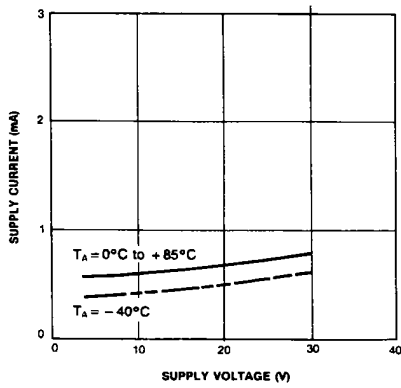

Figure 1. Supply Current vs Supply Voltage

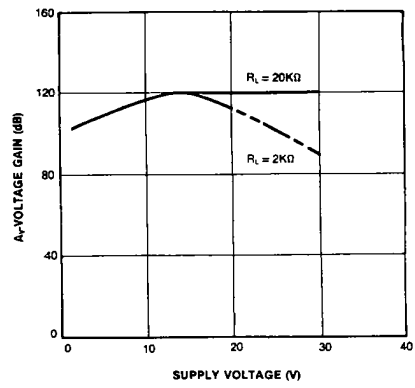

Figure 2. Voltage Gain vs Supply Voltage

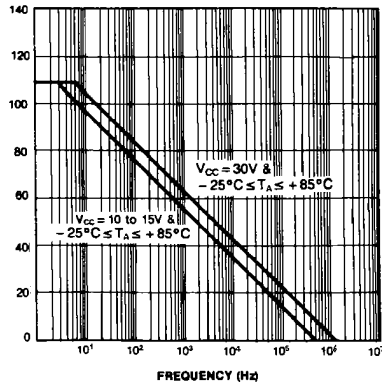

Figure 3. Open Loop Frequency Response

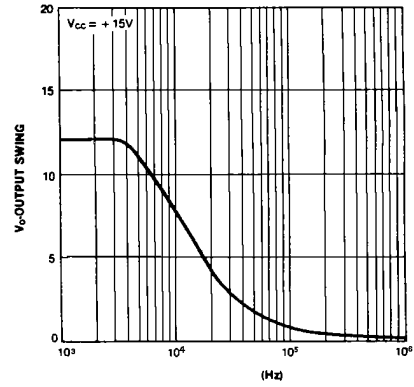

Figure 4. Large Signal Output Swing vs Frequency

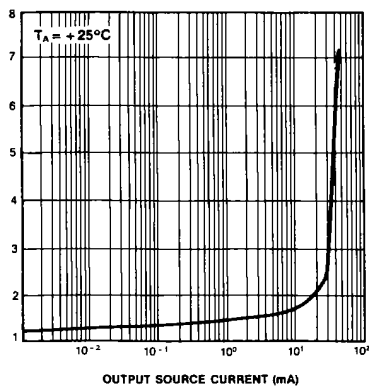

Figure 5. Output Characteristics vs Current Sourcing

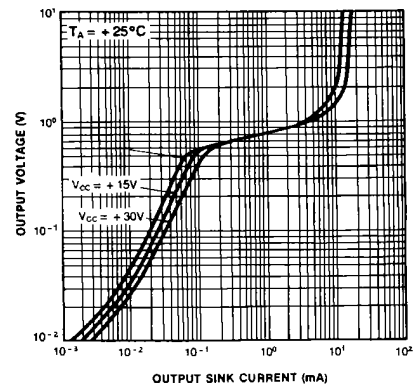

Figure 6. Output Characteristics vs Current Sinking

Typical Performance Characteristics (Continued)

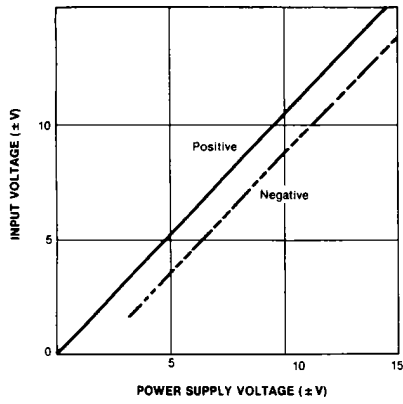

Figure 7. Input Voltage Range vs Supply Voltage

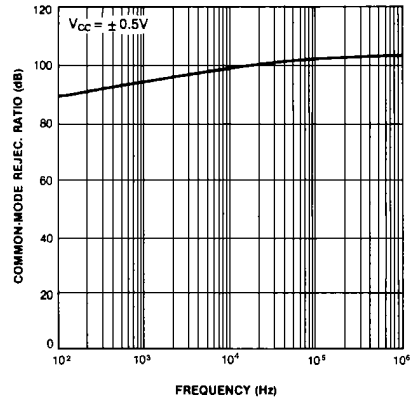

Figure 8. Common-Mode Rejection Ratio

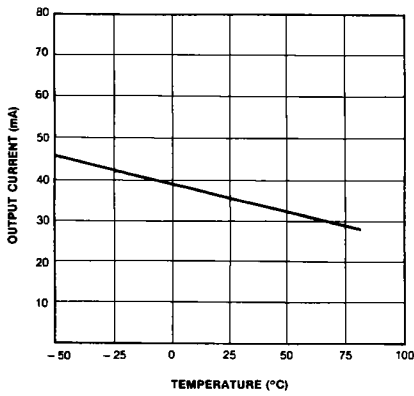

Figure 9. Output Current vs Temperature (Current Limiting)

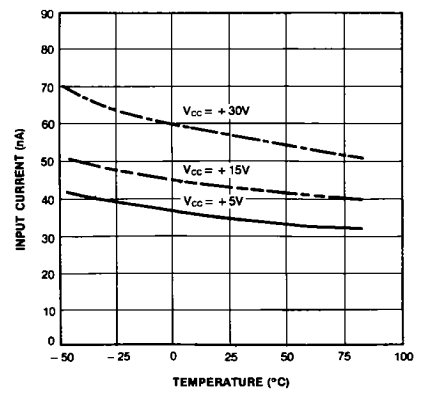

Figure 10. Input Current vs Temperature

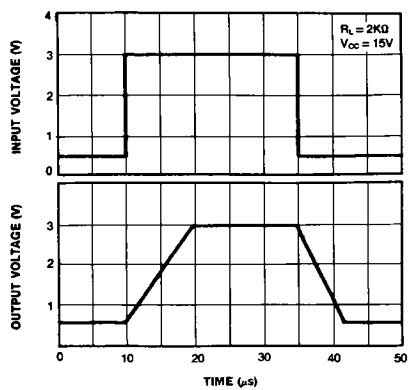

Figure 11. Voltage Follower Pulse Response

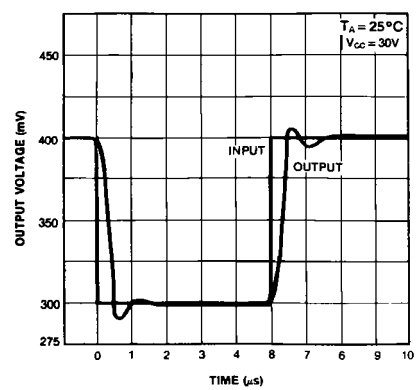

Figure 12. Voltage Follower Pulse Response (Small Signal)



# Mechanical Dimensions

## Package

Dimensions in millimeters

### 8-DIP

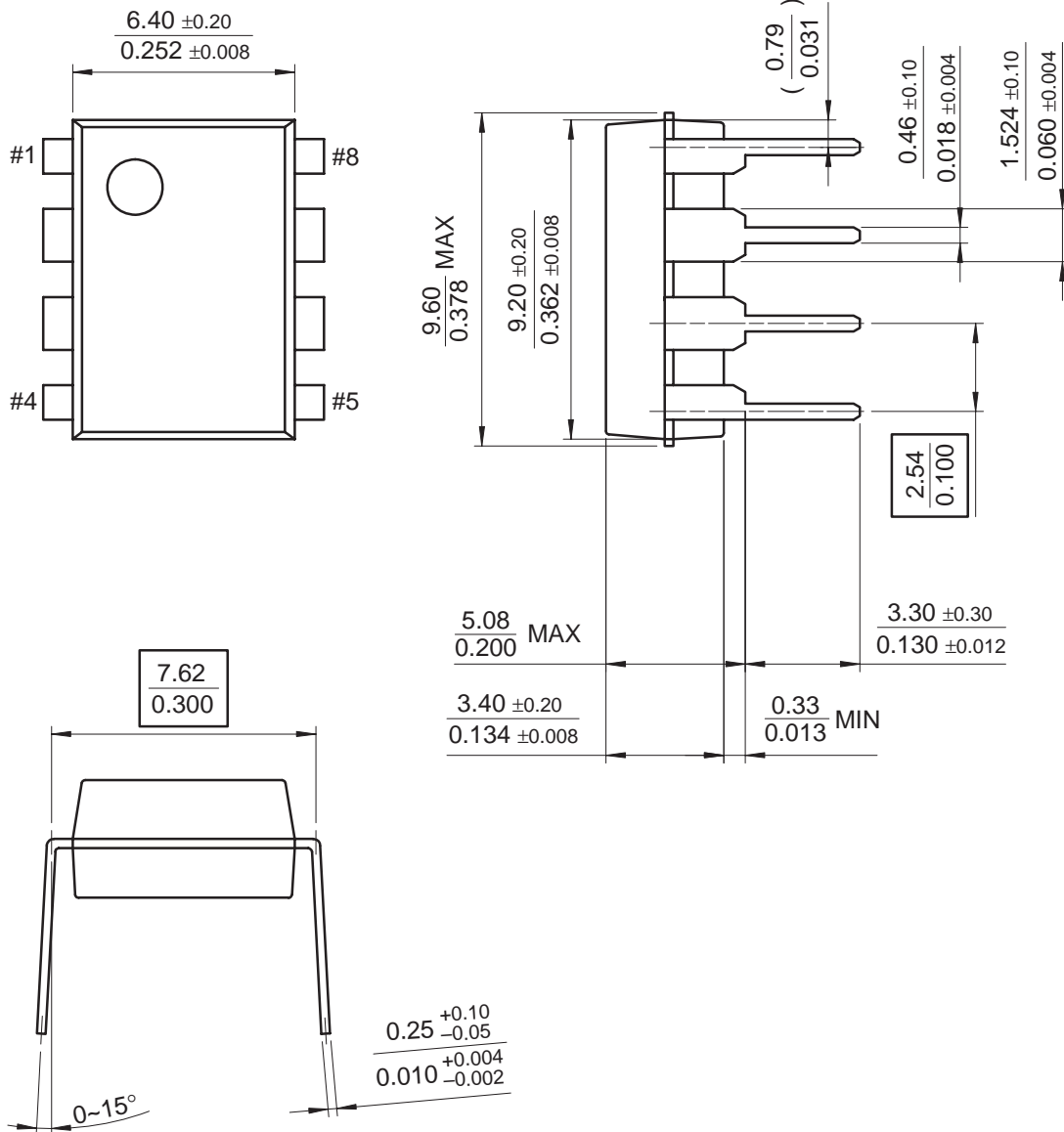

**Mechanical Dimensions** (Continued)

Package

Dimensions in millimeters

**8-SOP**

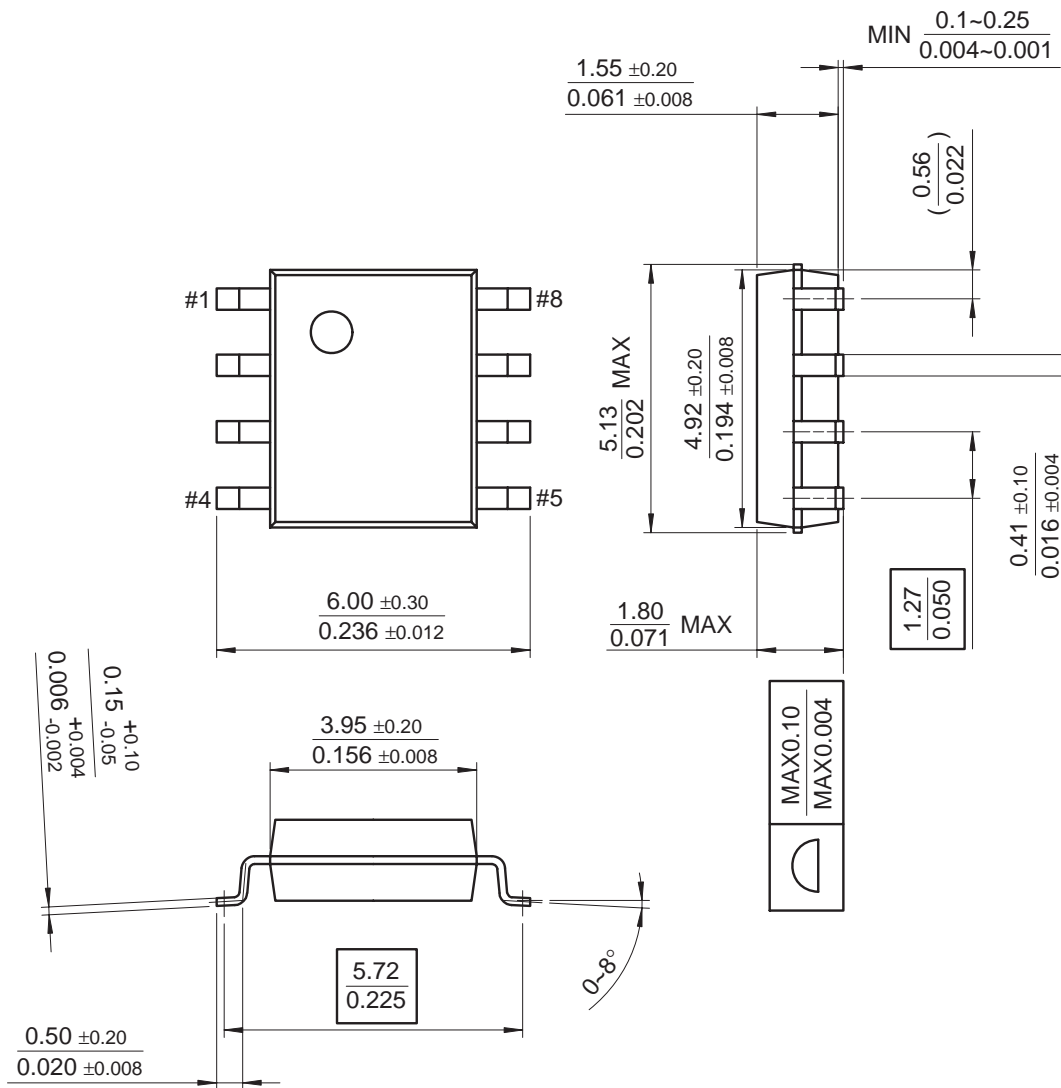

**Mechanical Dimensions** (Continued)

Package

Dimensions in millimeters

**9-SIP**

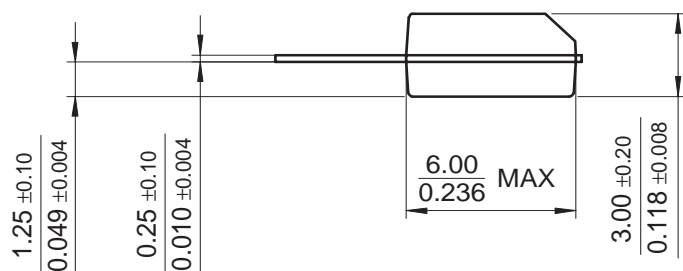
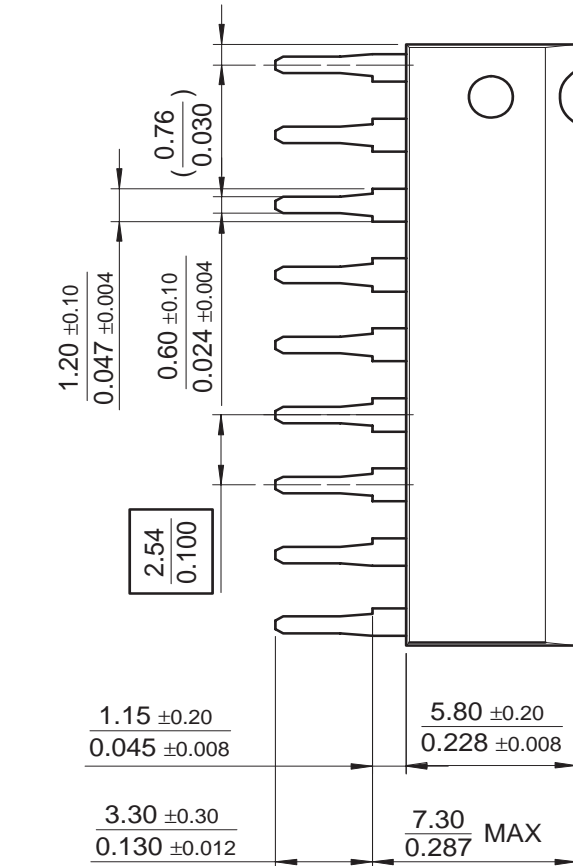
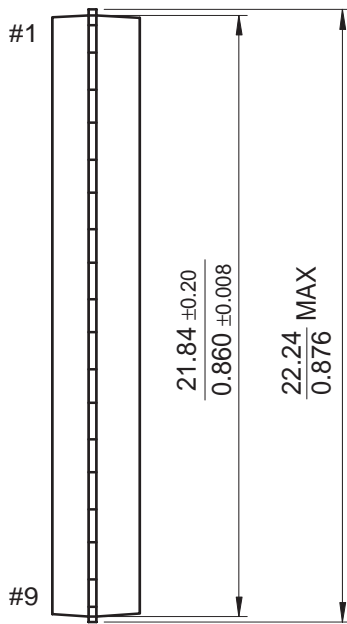

## Ordering Information

Product Number	Package	Operating Temperature
KA358	8-DIP	0 ~ +70°C
KA358A		
KA358D	8-SOP	
KA358AD		
KA358S	9-SIP	
KA358AS		
KA258	8-DIP	-25 ~ +85°C
KA258A		
KA258D	8-SOP	
KA258AD		
KA2904	8-DIP	-40 ~ +85°C
KA2904D	8-SOP	

### DISCLAIMER

FAIRCHILD SEMICONDUCTOR RESERVES THE RIGHT TO MAKE CHANGES WITHOUT FURTHER NOTICE TO ANY PRODUCTS HEREIN TO IMPROVE RELIABILITY, FUNCTION OR DESIGN. FAIRCHILD DOES NOT ASSUME ANY LIABILITY ARISING OUT OF THE APPLICATION OR USE OF ANY PRODUCT OR CIRCUIT DESCRIBED HEREIN; NEITHER DOES IT CONVEY ANY LICENSE UNDER ITS PATENT RIGHTS, NOR THE RIGHTS OF OTHERS.

### LIFE SUPPORT POLICY

FAIRCHILD'S PRODUCTS ARE NOT AUTHORIZED FOR USE AS CRITICAL COMPONENTS IN LIFE SUPPORT DEVICES OR SYSTEMS WITHOUT THE EXPRESS WRITTEN APPROVAL OF THE PRESIDENT OF FAIRCHILD SEMICONDUCTOR CORPORATION. As used herein:

1. Life support devices or systems are devices or systems which, (a) are intended for surgical implant into the body, or (b) support or sustain life, and (c) whose failure to perform when properly used in accordance with instructions for use provided in the labeling, can be reasonably expected to result in a significant injury of the user.
2. A critical component in any component of a life support device or system whose failure to perform can be reasonably expected to cause the failure of the life support device or system, or to affect its safety or effectiveness.