

SN74LS541

Octal Buffer/Line Driver with 3-State Outputs

The SN74LS541 is an octal buffer and line driver with the same functions as the LS241, but with pinouts on the opposite side of the package.

This device type is designed to be used as a memory address driver, clock driver and bus-oriented transmitter/receiver. This device is especially useful as output ports for the microprocessors, allowing ease of layout and greater PC board density.

- Hysteresis at Inputs to Improve Noise Margin
- PNP Inputs Reduce Loading
- 3-State Outputs Drive Bus Lines
- Inputs and Outputs Opposite Side of Package, Allowing Easier Interface to Microprocessors
- Input Clamp Diodes Limit High-Speed Termination Effects

LOGIC AND CONNECTION DIAGRAM DIP (TOP VIEW)

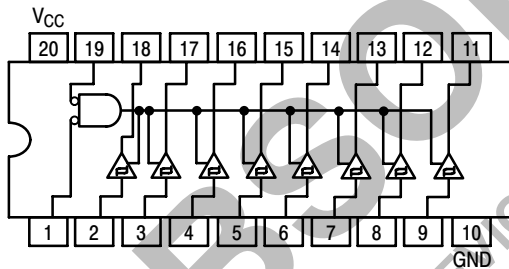

GUARANTEED OPERATING RANGES

Symbol	Parameter	Min	Typ	Max	Unit
V _{CC}	Supply Voltage	4.75	5.0	5.25	V
T _A	Operating Ambient Temperature Range	0	25	70	°C
I _{OH}	Output Current - High			-15	mA
I _{OL}	Output Current - Low			24	mA



ON Semiconductor™

<http://onsemi.com>

LOW
POWER
SCHOTTKY

MARKING DIAGRAMS

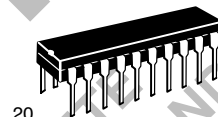

PDIP-20
N SUFFIX
CASE 738

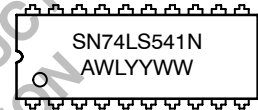

SOIC-20
DW SUFFIX
CASE 751D

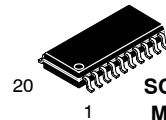
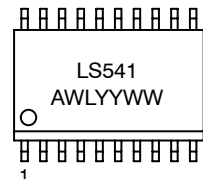

SOEIAJ-20
M SUFFIX
CASE 967



A = Assembly Location
WL = Wafer Lot
Y, YY = Year
WW = Work Week

ORDERING INFORMATION

Device	Package	Shipping
SN74LS541N	PDIP-20	1440 Units/Box
SN74LS541DW	SOIC-WIDE	38 Units/Rail
SN74LS541DWR2	SOIC-WIDE	2500/Tape & Reel
SN74LS541M	SOEIAJ-20	See Note 1
SN74LS541MEL	SOEIAJ-20	See Note 1

1. For ordering information on the EIAJ version of the SOIC package, please contact your local ON Semiconductor representative.

SN74LS541

BLOCK DIAGRAM

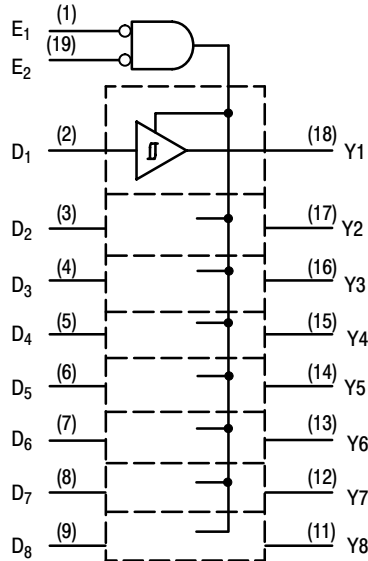

INPUTS			OUTPUTS	
E ₁	E ₂	D	LS540	LS541
L	L	H	L	H
H	X	X	Z	Z
X	H	X	Z	Z
L	L	L	H	L

L = LOW Voltage Level
H = HIGH Voltage Level
X = Immaterial
Z = High Impedance

DC CHARACTERISTICS OVER OPERATING TEMPERATURE RANGE (unless otherwise specified)

Symbol	Parameter	Limits			Unit	Test Conditions
		Min	Typ	Max		
V _{IH}	Input HIGH Voltage	2.0			V	Guaranteed Input HIGH Voltage for All Inputs
V _{IL}	Input LOW Voltage			0.8	V	Guaranteed Input LOW Voltage for All Inputs
V _{IK}	Input Clamp Diode Voltage		-0.65	-1.5	V	V _{CC} = MIN, I _{IN} = -18 mA
V _{OH}	Output HIGH Voltage	2.4	3.4		V	V _{CC} = MIN, I _{OH} = -3.0 mA
		2.0			V	V _{CC} = MIN, I _{OH} = MAX, V _{IL} = 0.5 V
V _{OL}	Output LOW Voltage		0.25	0.4	V	I _{OL} = 12 mA
			0.35	0.5	V	I _{OL} = 24 mA
V _{T+} -V _{T-}	Hysteresis	0.2	0.4		V	V _{CC} = MIN
I _{OZH}	Output Off Current HIGH			20	μA	V _{CC} = MAX, V _{OUT} = 2.7 V
I _{OZL}	Output Off Current LOW			-20	μA	V _{CC} = MAX, V _{OUT} = 0.4 V
I _{IH}	Input HIGH Current			20	μA	V _{CC} = MAX, V _{IN} = 2.7 V
				0.1	mA	V _{CC} = MAX, V _{IN} = 7.0 V
I _{IL}	Input LOW Current			-0.2	mA	V _{CC} = MAX, V _{IN} = 0.4 V
I _{OS}	Short Circuit Current (Note 1)	-40		-225	mA	V _{CC} = MAX
I _{CC}	Power Supply Current Total, Output HIGH			32	mA	V _{CC} = MAX
	Total, Output LOW			52	mA	
	Total Output 3-State			55	mA	

1. Not more than one output should be shorted at a time, nor for more than 1 second.

SN74LS541

AC CHARACTERISTICS ($T_A = 25^\circ\text{C}$)

Symbol	Parameter	Limits			Unit	Test Conditions
		Min	Typ	Max		
t_{PLH}	Propagation Delay, Data to Output		12	15	ns	$V_{CC} = 5.0\text{ V}$ $C_L = 45\text{ pF}$ $R_L = 667\ \Omega$
t_{PHL}			12	18		
t_{PZH}	Output Enable Time to HIGH Level		15	32	ns	
t_{PZL}	Output Enable Time to LOW Level		20	38	ns	
t_{PHZ}	Output Disable Time to HIGH Level		10	18	ns	$C_L = 5.0\text{ pF}$
t_{PLZ}	Output Disable Time to LOW Level		15	29	ns	

AC WAVEFORMS

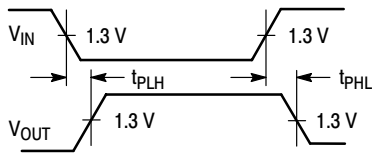

Figure 1.

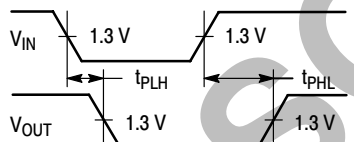

Figure 2.

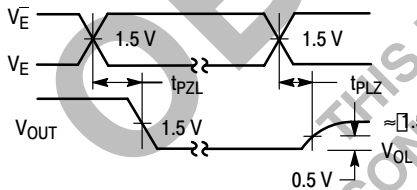

Figure 3.

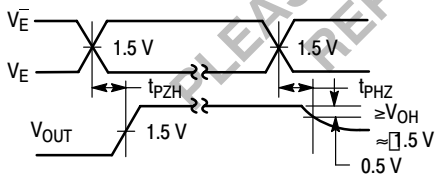
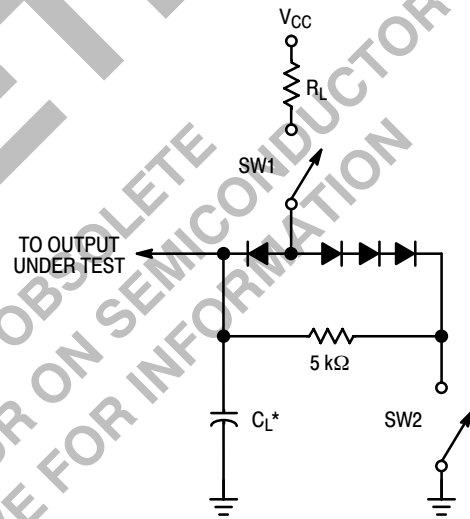

Figure 4.



SWITCH POSITIONS

SYMBOL	SW1	SW2
t_{PZH}	Open	Closed
t_{PZL}	Closed	Open
t_{PLZ}	Closed	Closed
t_{PHZ}	Closed	Closed

Figure 5.

SN74LS541

PACKAGE DIMENSIONS

N SUFFIX
PLASTIC PACKAGE
CASE 738-03
ISSUE E

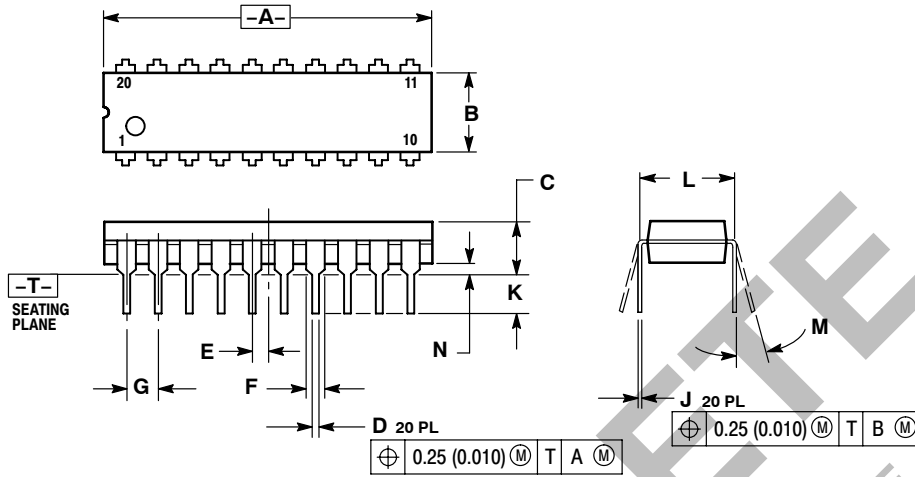

NOTES:

1. DIMENSIONING AND TOLERANCING PER ANSI Y14.5M, 1982.
2. CONTROLLING DIMENSION: INCH.
3. DIMENSION L TO CENTER OF LEAD WHEN FORMED PARALLEL.
4. DIMENSION B DOES NOT INCLUDE MOLD FLASH.

DIM	INCHES		MILLIMETERS	
	MIN	MAX	MIN	MAX
A	1.010	1.070	25.66	27.17
B	0.240	0.260	6.10	6.60
C	0.150	0.180	3.81	4.57
D	0.015	0.022	0.39	0.55
E	0.050 BSC		1.27 BSC	
F	0.050	0.070	1.27	1.77
G	0.100 BSC		2.54 BSC	
J	0.008	0.015	0.21	0.38
K	0.110	0.140	2.80	3.55
L	0.300 BSC		7.62 BSC	
M	0°	15°	0°	15°
N	0.020	0.040	0.51	1.01

OBSOLETE

THIS DEVICE IS OBSOLETE
 PLEASE CONTACT YOUR ON SEMICONDUCTOR
 REPRESENTATIVE FOR INFORMATION

SN74LS541

PACKAGE DIMENSIONS

D SUFFIX
PLASTIC SOIC PACKAGE
 CASE 751D-05
 ISSUE F

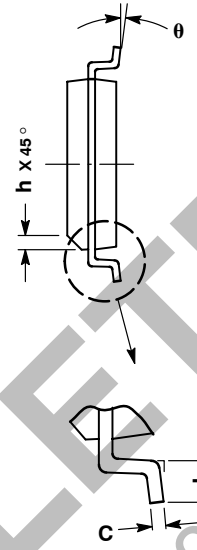
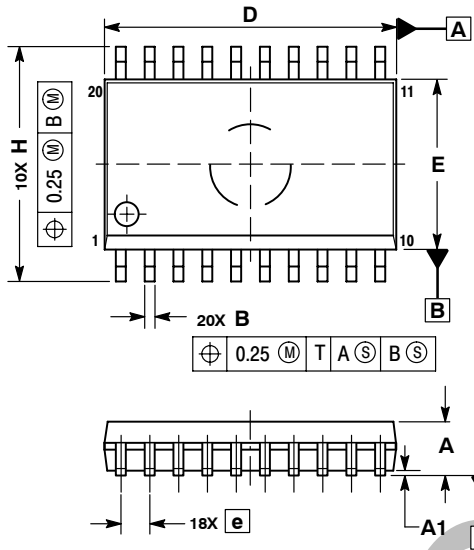

- NOTES:
1. DIMENSIONS ARE IN MILLIMETERS.
 2. INTERPRET DIMENSIONS AND TOLERANCES PER ASME Y14.5M, 1994.
 3. DIMENSIONS D AND E DO NOT INCLUDE MOLD PROTRUSION.
 4. MAXIMUM MOLD PROTRUSION 0.15 PER SIDE.
 5. DIMENSION B DOES NOT INCLUDE DAMBAR PROTRUSION. ALLOWABLE PROTRUSION SHALL BE 0.13 TOTAL IN EXCESS OF B DIMENSION AT MAXIMUM MATERIAL CONDITION.

DIM	MILLIMETERS	
	MIN	MAX
A	2.35	2.65
A1	0.10	0.25
B	0.35	0.49
C	0.23	0.32
D	12.65	12.95
E	7.40	7.60
e	1.27 BSC	
H	10.05	10.55
h	0.25	0.75
L	0.50	0.90
θ	0°	7°

OBSOLETE

THIS DEVICE IS OBSOLETE
 PLEASE CONTACT YOUR ON SEMICONDUCTOR
 REPRESENTATIVE FOR INFORMATION

SN74LS541

PACKAGE DIMENSIONS

M SUFFIX
SOEIAJ PACKAGE
CASE 967-01
ISSUE O

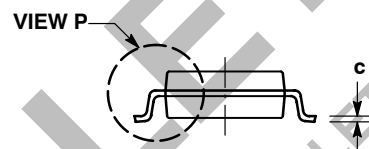
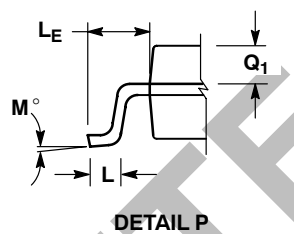
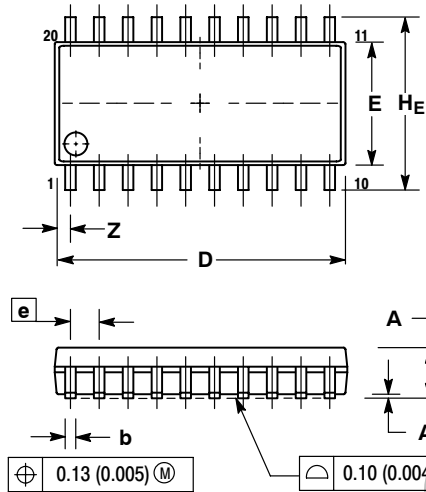

- NOTES:
1. DIMENSIONING AND TOLERANCING PER ANSI Y14.5M, 1982.
 2. CONTROLLING DIMENSION: MILLIMETER.
 3. DIMENSIONS D AND E DO NOT INCLUDE MOLD FLASH OR PROTRUSIONS AND ARE MEASURED AT THE PARTING LINE. MOLD FLASH OR PROTRUSIONS SHALL NOT EXCEED 0.15 (0.006) PER SIDE.
 4. TERMINAL NUMBERS ARE SHOWN FOR REFERENCE ONLY.
 5. THE LEAD WIDTH DIMENSION (b) DOES NOT INCLUDE DAMBAR PROTRUSION. ALLOWABLE DAMBAR PROTRUSION SHALL BE 0.08 (0.003) TOTAL IN EXCESS OF THE LEAD WIDTH DIMENSION AT MAXIMUM MATERIAL CONDITION. DAMBAR CANNOT BE LOCATED ON THE LOWER RADIUS OR THE FOOT. MINIMUM SPACE BETWEEN PROTRUSIONS AND ADJACENT LEAD TO BE 0.46 (0.018).

DIM	MILLIMETERS		INCHES	
	MIN	MAX	MIN	MAX
A	---	2.05	---	0.081
A ₁	0.05	0.20	0.002	0.008
b	0.35	0.50	0.014	0.020
c	0.18	0.27	0.007	0.011
D	12.35	12.80	0.486	0.504
E	5.10	5.45	0.201	0.215
e	1.27 BSC		0.050 BSC	
H _E	7.40	8.20	0.291	0.323
L	0.50	0.85	0.020	0.033
L _E	1.10	1.50	0.043	0.059
M	0 °	10 °	0 °	10 °
Q ₁	0.70	0.90	0.028	0.035
Z	---	0.81	---	0.032

ON Semiconductor and **ON** are registered trademarks of Semiconductor Components Industries, LLC (SCILLC). SCILLC reserves the right to make changes without further notice to any products herein. SCILLC makes no warranty, representation or guarantee regarding the suitability of its products for any particular purpose, nor does SCILLC assume any liability arising out of the application or use of any product or circuit, and specifically disclaims any and all liability, including without limitation special, consequential or incidental damages. "Typical" parameters which may be provided in SCILLC data sheets and/or specifications can and do vary in different applications and actual performance may vary over time. All operating parameters, including "Typicals" must be validated for each customer application by customer's technical experts. SCILLC does not convey any license under its patent rights nor the rights of others. SCILLC products are not designed, intended, or authorized for use as components in systems intended for surgical implant into the body, or other applications intended to support or sustain life, or for any other application in which the failure of the SCILLC product could create a situation where personal injury or death may occur. Should Buyer purchase or use SCILLC products for any such unintended or unauthorized application, Buyer shall indemnify and hold SCILLC and its officers, employees, subsidiaries, affiliates, and distributors harmless against all claims, costs, damages, and expenses, and reasonable attorney fees arising out of, directly or indirectly, any claim of personal injury or death associated with such unintended or unauthorized use, even if such claim alleges that SCILLC was negligent regarding the design or manufacture of the part. SCILLC is an Equal Opportunity/Affirmative Action Employer. This literature is subject to all applicable copyright laws and is not for resale in any manner.

PUBLICATION ORDERING INFORMATION

LITERATURE FULFILLMENT:
 Literature Distribution Center for ON Semiconductor
 P.O. Box 5163, Denver, Colorado 80217 USA
Phone: 303-675-2175 or 800-344-3860 Toll Free USA/Canada
Fax: 303-675-2176 or 800-344-3867 Toll Free USA/Canada
Email: orderlit@onsemi.com

N. American Technical Support: 800-282-9855 Toll Free USA/Canada
Europe, Middle East and Africa Technical Support:
 Phone: 421 33 790 2910
Japan Customer Focus Center
 Phone: 81-3-5773-3850

ON Semiconductor Website: www.onsemi.com
Order Literature: <http://www.onsemi.com/orderlit>
 For additional information, please contact your local Sales Representative