

# SMD Aluminum Electrolytic Capacitors

## AEA Series



### FEATURES

- Low Impedance, 105°C 2,000 - 5,000 hours
- Applicable to SMT Process
- RoHS Compliance

### APPLICATIONS

- Industrial/Consumer Electronics
- Lighting
- DC/DC Converters



LEAD-FREE  
LEAD-FREE COMPATIBLE  
COMPONENT



RoHS  
COMPLIANT

### HOW TO ORDER

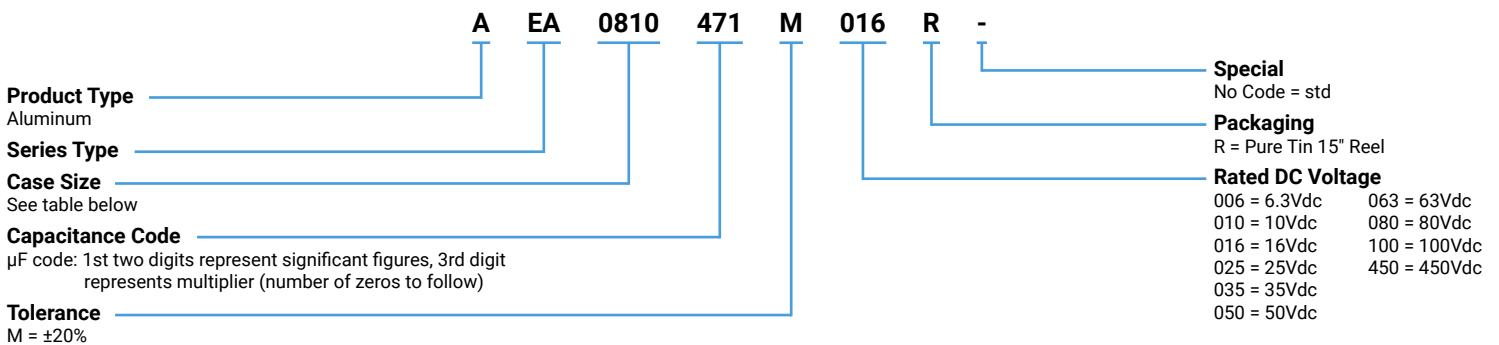

### CASE DIMENSIONS millimeters (inches)

Code	D±0.50 (0.020)	L±0.50 (0.020)	W±0.20 (0.008)	H±0.20 (0.008)	C±0.20 (0.008)	R	P±0.30 (0.012)	V max	Typical Weight (g)
0810	8.00 (0.315)	10.50 (0.413)	8.30 (0.327)	8.30 (0.327)	9.00 (0.354)	0.70 - 1.10 (0.028 - 0.043)	3.20 (0.126)	0.30 (0.012)	0.75
1010	10.00 (0.394)	10.00 (0.394)	10.30 (0.406)	10.30 (0.406)	11.00 (0.433)	0.70 - 1.30 (0.028 - 0.051)	4.50 (0.177)	0.30 (0.012)	1.37
1213	12.50 (0.492)	13.50 (0.531)	13.00 (0.512)	13.00 (0.512)	13.70 (0.539)	1.10 - 1.40 (0.043 - 0.055)	4.50 (0.177)	0.40 (0.016)	2.67
1216	12.50 (0.492)	16.50 (0.650)	13.00 (0.512)	13.00 (0.512)	13.70 (0.539)	1.10 - 1.40 (0.043 - 0.055)	4.50 (0.177)	0.40 (0.016)	3.09
1616	16.00 (0.630)	16.50 (0.650)	17.00 (0.669)	17.00 (0.669)	18.00 (0.709)	1.40 - 1.80 (0.055 - 0.071)	6.40 (0.252)	0.40 (0.016)	5.33

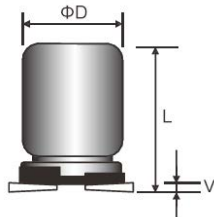
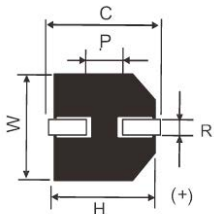

### TECHNICAL SPECIFICATIONS

<b>Category Temperature Range:</b>	-55°C to + 105°C (6.3 - 100V), -40°C to +105°C (450V)	
<b>Capacitance Range:</b>	At 25°C, 120Hz	3.3µF to 6800µF
<b>Capacitance Tolerance:</b>	At 25°C, 120Hz	±20%
<b>Dissipation Factor %</b>	Measurement Frequency: 120Hz at 25°C	Please see the ratings and part number reference table below.
<b>Leakage Current</b>	After 2 minutes at rated working voltage at 25°C*	I ≤ 0.01CV or 3µA whichever is greater

\* Note: In the case of an anomalous reading, re-measure the leakage current after following voltage treatment:  
Voltage treatment: DC rated voltage to be applied to the capacitors for 120 minutes at 105°C.

### MARKING

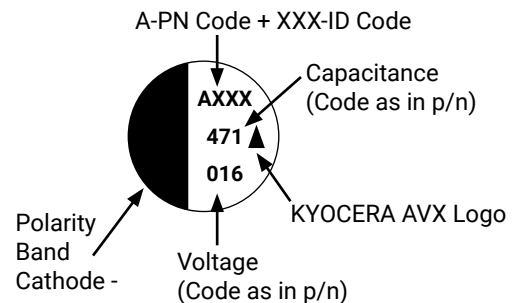

# SMD Aluminum Electrolytic Capacitors

## AEA Series

### CAPACITANCE AND RATED VOLTAGE RANGE (FIGURES DENOTES CASE SIZE)

Capacitance		Rated Voltage DC (V <sub>R</sub> )									
μF	Code	6.3V	10V	16V	25V	35V	50V	63V	80V	100V	450V
3.3	3R3										1213
4.7	4R7										1213
10	100										1216
22	220									0810	1616
33	330								0810	1010	
47	470							0810	1010	1213	
56	560						0810	1010			
68	680						0810			1213	
100	101					0810	0810	1213	1213	1616	
150	151				0810	0810	1010	1213	1213	1616	
220	221				0810	1010	1010	1213			
330	331		0810	0810	0810		1213	1616	1616		
470	471	0810	0810	0810	1010	1213	1616	1616			
680	681	0810	1010	1010	1213	1213	1616				
1000	102	0810	1010	1010, 1213	1213	1616	1616				
1500	152	1010	1213	1213	1616	1616					
2200	222	1213	1213		1616						
3300	332			1616							
4700	472		1616								
6800	682	1616									

Released ratings

### RATINGS & PART NUMBER REFERENCE

Part No.	Case Size	Capacitance (μF)	Rated Voltage (V)	DCL Max. (μA)	DF Max. (%)	100kHz RMS Current (mA)/105°C	Impedance 100kHz Max. (Ω)
<b>6.3 Volt</b>							
AEA0810471M006R	0810	470	6.3	30	30	600	0.17
AEA0810681M006R	0810	680	6.3	43	30	600	0.17
AEA0810102M006R	0810	1000	6.3	63	30	600	0.17
AEA1010152M006R	1010	1500	6.3	95	30	850	0.09
AEA1213222M006R	1213	2200	6.3	139	30	1100	0.06
AEA1616682M006R	1616	6800	6.3	428	30	1800	0.035
<b>10 Volt</b>							
AEA0810331M010R	0810	330	10	33	26	600	0.17
AEA0810471M010R	0810	470	10	47	26	600	0.17
AEA1010681M010R	1010	680	10	68	26	850	0.09
AEA1010102M010R	1010	1000	10	100	26	850	0.09
AEA1213152M010R	1213	1500	10	150	26	1100	0.06
AEA1213222M010R	1213	2200	10	220	26	1100	0.06
AEA1616472M010R	1616	4700	10	470	26	1800	0.035
<b>16 Volt</b>							
AEA0810331M016R	0810	330	16	53	22	600	0.17
AEA0810471M016R	0810	470	16	75	22	600	0.17
AEA1010681M016R	1010	680	16	109	22	850	0.09
AEA1010102M016R	1010	1000	16	160	22	850	0.09
AEA1213102M016R	1213	1000	16	160	22	1100	0.06
AEA1213152M016R	1213	1500	16	240	22	1100	0.06
AEA1616332M016R	1616	3300	16	528	22	1800	0.035
<b>25 Volt</b>							
AEA0810151M025R	0810	150	25	37.5	16	600	0.17
AEA0810221M025R	0810	220	25	55	16	600	0.17
AEA0810331M025R	0810	330	25	82.5	16	600	0.17
AEA1010471M025R	1010	470	25	117.5	16	850	0.09
AEA1213681M025R	1213	680	25	170	16	1100	0.06
AEA1213102M025R	1213	1000	25	250	16	1100	0.06
AEA1616152M025R	1616	1500	25	375	16	1800	0.035
AEA1616222M025R	1616	2200	25	550	16	1800	0.035

# SMD Aluminum Electrolytic Capacitors

## AEA Series

### RATINGS & PART NUMBER REFERENCE

Part No.	Case Size	Capacitance (μF)	Rated Voltage (V)	DCL Max. (μA)	DF Max. (%)	100kHz RMS Current (mA)/105°C	Impedance 100kHz Max. (Ω)
<b>35 Volt</b>							
AEA0810101M035R	0810	100	35	35	14	600	0.17
AEA0810151M035R	0810	150	35	53	14	600	0.17
AEA1010221M035R	1010	220	35	77	14	850	0.09
AEA1213471M035R	1213	470	35	165	14	1100	0.06
AEA1213681M035R	1213	680	35	238	14	1100	0.06
AEA1616102M035R	1616	1000	35	350	14	1800	0.035
AEA1616152M035R	1616	1500	35	525	14	1800	0.035
<b>50 Volt</b>							
AEA0810560M050R	0810	56	50	28	14	330	0.34
AEA0810680M050R	0810	68	50	34	14	330	0.34
AEA0810101M050R	0810	100	50	50	14	330	0.34
AEA1010151M050R	1010	150	50	75	14	670	0.18
AEA1010221M050R	1010	220	50	110	14	670	0.18
AEA1213331M050R	1213	330	50	165	14	900	0.12
AEA1616471M050R	1616	470	50	235	14	1610	0.073
AEA1616681M050R	1616	680	50	340	14	1610	0.073
AEA1616102M050R	1616	1000	50	500	14	1610	0.073
<b>63 Volt</b>							
AEA0810470M063R	0810	47	63	30	8	200	0.7
AEA1010560M063R	1010	56	63	35	8	369	0.48
AEA1213101M063R	1213	100	63	63	8	800	0.16
AEA1213151M063R	1213	150	63	95	8	800	0.16
AEA1213221M063R	1213	220	63	139	8	800	0.16
AEA1616331M063R	1616	330	63	208	8	1410	0.082
AEA1616471M063R	1616	470	63	298	8	1410	0.082
<b>80 Volt</b>							
AEA0810330M080R	0810	33	80	26	8	130	1.88
AEA1010470M080R	1010	47	80	38	8	200	0.9
AEA1213101M080R	1213	100	80	80	8	500	0.32
AEA1213151M080R	1213	150	80	120	8	500	0.32
AEA1616331M080R	1616	330	80	264	8	793	0.17
<b>100 Volt</b>							
AEA0810220M100R	0810	22	100	22	7	130	1.88
AEA1010330M100R	1010	33	100	33	7	200	0.65
AEA1213470M100R	1213	47	100	47	7	500	0.32
AEA1213680M100R	1213	68	100	68	7	500	0.32
AEA1616101M100R	1616	100	100	100	7	793	0.17
AEA1616151M100R	1616	150	100	150	7	793	0.17
<b>450 Volt</b>							
AEA12133R3M450R	1213	3.3	450	159	25	60	*
AEA12134R7M450R	1213	4.7	450	184	25	67	*
AEA1216100M450R	1216	10	450	280	25	112	*
AEA1616220M450R	1616	22	450	496	25	127	*

\*Note: Impedance values upon request

All technical data relates to an ambient temperature of +25C. Capacitance and DF are measured at 120Hz, 0.5RMS with DC bias of 2.2 volts.

DCL is measured at rated voltage after 5 minutes.

### FREQUENCY COEFFICIENT OF PERMISSIBLE RIPPLE CURRENT

Capacitance Range	120 ≤ F(Hz) < 1K	1K ≤ F(Hz) < 10K	10K ≤ F(Hz) < 100K	100K(Hz) ≤ F
≤ 33	0.35	0.70	0.90	1.00
33 - 150	0.40	0.85	0.92	1.00
> 150	0.60	0.85	0.95	1.00

The endurance of capacitors is reduced with internal heating produced by ripple current at the rate of halving the lifetime with every 5% rise. When long life performance is required in actual use, the rms ripple current has to be reduced.

# SMD Aluminum Electrolytic Capacitors

## AEA Series

Rated Voltage (Vdc)	50	120	300	1K	≥10K
450	0.70	1.00	1.17	1.36	1.5

The endurance of capacitors is reduced with internal heating produced by ripple current at the rate of halving the lifetime with every 5°C rise.

### QUALIFICATION TABLE

Test	AEA series (Temperature Range -55°C to +105°C (6.3-100V), -40°C to +105°C (450V))												
	Condition	Characteristics											
Low Temperature Characteristics (Max. Impedance Ratio)	At 120Hz	Rated Voltage (V)	6.3	10	16	25	35	50	63	80	100	450	
		Z(-25°C) / Z(+20°C)	4	3	2	2	2	2	2	2	2	6	
		Z(-55°C) / Z(+20°C)	8	5	4	3	3	3	3	3	3	-	
		Z(-40°C) / Z(+20°C)	-	-	-	-	-	-	-	-	-	10	
Endurance	5000 hours, with application of rated voltage at 105°C	Rated Voltage (V)	6.3 - 100						450				
		Lifetime (h)	5000h						2000h				
		ΔC/C	Within ±30% of the initial limit						Within ±20% of the initial limit				
		DF	300% or less of the initial specified limit						200% or less of the initial specified limit				
		DCL	Initial specified limit or less										
Shelf Life	The following specifications shall be satisfied when the capacitors are restored to 20°C after exposing them for 1000 hours 105°C without voltage applied. Before the measurement, the capacitor shall be preconditioned by applying voltage according to them 4.1 of JIS C5101-4.	Rated Voltage (V)	6.3 - 100						450				
		ΔC/C	Within ±30% of the initial limit						Within ±20% of the initial limit				
		DF	300% or less of the initial specified limit						200% or less of the initial specified limit				
		DCL	Initial specified limit or less										
Resistance to Soldering Heat	The capacitors shall be kept on the hot plate maintained at 250°C for 30 seconds. After removing from the hot plate and restored at room temperature they meet the characteristics requirements listed at right.	ΔC/C	Within ±10% of the initial limit										
		DF	Initial specified limit										
		DCL	Initial specified limit or less										
Standards	JIS C 5101-4-1 (IEC 60384)												

### REFLOW

Diameter (mm)	Φ8 - 16
Peak Temperature	245°C, 5 sec. max.
Preheat Temperature	150°C to 180°C, 120 sec. max.
Duration at 217°C or Higher	90 sec. max.
Reflow Number	Twice or less

### STORAGE

- It is recommended to keep capacitors between the ambient temperatures of 5°C to 35°C and a relative humidity of 75% or below.
- Confirm that the environment does not have any of the following conditions:
  - Damp conditions such as water, saltwater spray, or oil spray or fumes. High humidity or humidity condensation situations.
  - In an atmosphere filled with toxic gasses (such as hydrogen sulfide, sulfurous acid, nitrous acid, chlorine, ammonia, etc.).
  - Being exposed to direct sunlight, ozone, ultraviolet ray, or radiation.
  - Being exposed to acidic or alkaline solutions.
  - Under severe conditions where vibration and / or mechanical shock exceed the applicable ranges of the specification.
- Storage life: 2 years

### PACKAGE TAPE DIMENSIONS units (mm)

Size Code	A±0.20	B±0.20	W±0.30	F±0.10	E±0.10	P±0.10	t±0.10	T±0.20
0810	8.7	8.7	24.0	11.5	1.75	16.0	0.4	11.0
1010	10.7	10.7	24.0	11.5	1.75	16.0	0.4	11.0
1213	13.4/13.7(G)	13.4/13.7(G)	32.0	14.2	1.75	24.0	0.4	14.5
1216	13.4/13.7(G)	13.4/13.7(G)	32.0	14.2	1.75	24.0	0.4	17.5
1616	17.5	17.5	44.0	20.2	1.75	28.0	0.4	17.5

„(G)” „Anti-vibration Structure”

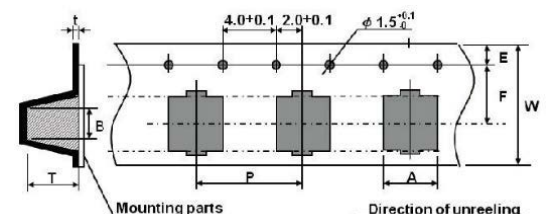

# SMD Aluminum Electrolytic Capacitors

## AEA Series

### REEL

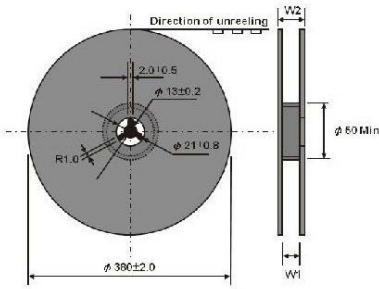

### POLARITY

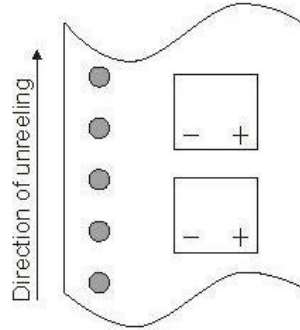

### DIMENSIONS units (mm)

Size Code	W1±1.00	W2±1.00	Qty./Reel
0810	26.0	31.0	500
1010	26.0	31.0	500
1213	34.0	39.0	250
1216	34.0	39.0	200
1616	46.0	51.0	200

### RECOMMENDED LAND PATTERN DIMENSION OF PCB

Size Code	A (mm)	B (mm)	C (mm)
0810	3.0	3.5	2.5
1010	4.0	4.0	2.5
1213	4.3	5.8	2.5
1216	4.3	5.8	2.5
1616	6.6	6.5	5.0

