

Approval Sheet 承 认 书

Comply With RoHS Directive

环保产品,符合欧盟 **RoHs** 指令

The device name 器件名称:	Aluminium Electrolytic Capacitor 铝电解电容
Supplier 供应商:	Dongguan E-TAK Electronics Co.,Ltd 东莞怡德电子有限公司
Supplier LOGO 厂商商标:	UNITED
Capacitance type / specification 电容型号/规格:	LW 22 μ F/50V 5x11
Material code: 物料编码:	LW220M0500511PE4
Customer material No. : 客户料号:	
APP. NO. 承认书编号:	CR20230913-021

Customer's Approval Stamp 客户承认印	Dongguan E-TAK Electronics Co.,Ltd 东莞怡德电子有限公司 	
	Approved 核准:	Formulate 拟制:
	王涛	况安兵

Change Records 变更记录

Version 版本	Change date 日期	Originator 责任人	Change Description 变更描述	Checked 审核

Table of specification and characteristics 规格和特性表

Customer material No. 客户料号	Spec. 规格	CAP 静电容量 (μ F) 120Hz 20°C	Rated voltage 额定电压 (V)	CAP Tol 容量公差 (%)	DF 损失角 (%) 120Hz 20°C	LC 泄漏电流 (μ A) 2min 20°C	ESR 阻抗值 (m Ω) 100KHz 20°C	RC 纹波电流 (mA) 100KHz 105°C	Load life 负荷寿命 (Hrs) 105°C	Size 尺寸 mm Φ D × L	Pitch 脚距 P (mm)	Forming method 成型方式 (mm)
	22 μ F/50V	22	50	\pm 20	10	11	900	200	2000	5x11	2.0	标准品

1、Scope 范围

This standard defines characteristics and dimensions for aluminum electrolytic capacitors named LW Series is low impedance and high ripple product. 此标准描述了铝电解电容器低阻抗高纹波 LW 系列的特性和尺寸。

2、Construction & Dimensions 尺寸图

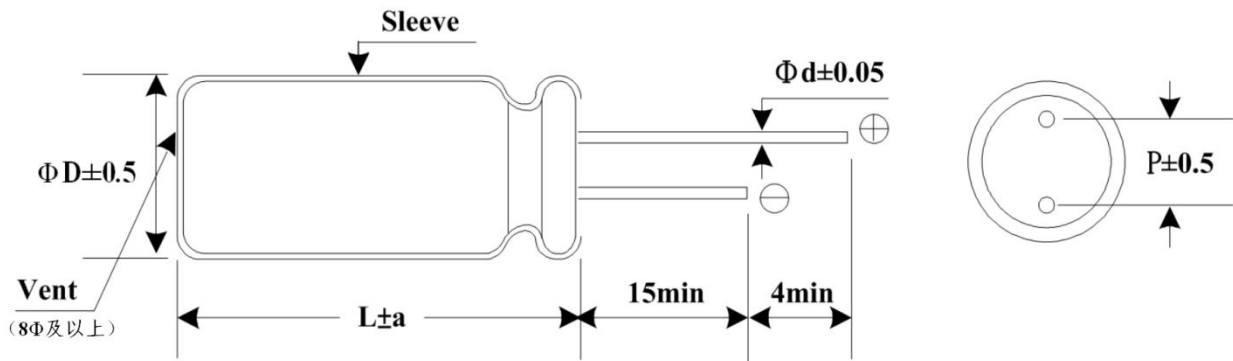

Diameter 直径(Φ D)	4	5	6.3	8	10	12.5	13	16	18	22
Lead space 引线间距(P)	1.5	2.0	2.5	3.5	5.0	5.0	5.0	7.5	7.5	10
Lead diameter 引线直径(ϕ d)	0.45	0.5	0.5	0.5	0.6	0.6	0.6	0.8	0.8	0.8
a	1.5	1.5	1.5	1.5	1.5	1.5	1.5	2.0	2.0	3.0

3、Characteristics 特性

3.1、Standard test condition 标准试验条件

Unless otherwise specified all tests shall be performed at, or referred to, an ambient temperature of 20°C and a relative humidity not greater than 60%. 所有的试验应在环境温度 20°C 和相对湿度小于等于 60% 的条件下进行，除非另有规定。

3.2、Operating Temperature Range 工作温度范围

Room 201, Building 6, Yinmandi High-tech Industrial Park, No. 2, Qinghu Minyingyuan Road, Qishi Town, Dongguan City, Guangdong Province 广东省东莞市企石镇清湖民营园路 2 号银满地高新产业园 6 号楼 201 室

DC 6.3~100V -40~+105°C

DC 160~500V -25~+105°C

4、Electrical characteristics 电气特性

4.1、Rated Voltage and Surge Voltage 额定电压和浪涌电压

WV: Working Voltage 工作电压(VDC)

SV: Surge Voltage 浪涌电压 (V)

WV	6.3	10	16	25	35	50	63	100	160	200	250	350	400	450	500
SV	8	13	20	32	44	63	79	125	200	250	300	400	450	500	550

4.2、Leakage Current 漏电流

The maximum leakage current is specified in the following formula after DC working voltage applied for 2 minutes. 施加直流工作电压 2 分钟后的最大漏电流值如下列公式所示:

6.3~100WV $I=0.01CV$ or 3 (μA), Whichever is greater 任意一个较大值.

160~450WV $I=0.03CV+10(\mu A)$

where I: Leakage Current (μA)

C: Nominal Capacitance (μF)

V: Rated Voltage (V)

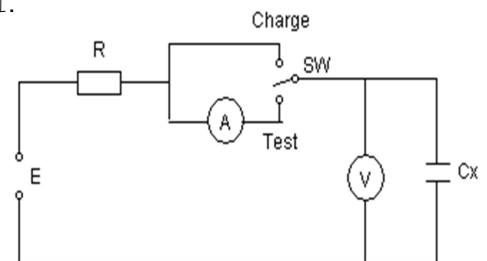

4.3、Dissipation Factor 损失角

Dissipation Factor at 120Hz/ 20°C shall not exceed the values given in the table below. 在 120 Hz / 20°C 条件下的 DF 值不应超过下表中给出的值。

WV	6.3	10	16	25	35	50	63	100	160	200	250	350	400	450	500
DF(%)	22	19	16	14	12	10	9	8	20	20	20	24	24	24	24

Note: Above DF specifications shall be 2% added for every 1000 μF capacitor exceeding 1000 μF .

注: 当静电容量超过 1000 μF 时, 每增加 1000 μF , 则以上损失角规格值应增加 2%。

4.4、Low Temperature Characteristics 低温特性

The ratio of impedance at -25°C/+20°C and -40°C/+20°C of the capacitor shall be less than the following value at 120Hz. 电容器在 120Hz 的条件下, 分别在 -25°C/+20°C 和 -40°C/+20°C 的阻抗比, 应小于以下的规格值。

Rated voltage 额定电压(V)	6.3	10	16	25	35	50~100	160~250	350~400	450~500
Z(-25°C) / Z(+20°C)	5	4	3	2	2	2	3	6	6
Z(-40°C) / Z(+20°C)	12	10	8	5	4	3	4	6	/

4.5、Multiplier for Ripple Current 纹波电流修正系数

Frequency 频率	120Hz	1KHz	10KHz	100KHz
$CAP \leq 180\mu F$	0.40	0.75	0.90	1.00
$180\mu F < CAP \leq 560\mu F$	0.50	0.83	0.93	1.00
$560\mu F < CAP \leq 1800\mu F$	0.60	0.86	0.95	1.00
$1800\mu F < CAP \leq 3900\mu F$	0.75	0.90	0.97	1.00
$CAP > 3900\mu F$	0.85	0.95	0.98	1.00

5、Mechanical Characterisitcs 机械特性

Lead Pull Test 导针拉力测试

Capacitors shall be with stand the pull test shown in the following table.

电容器的导针应能承受下表所示的拉力测试

Lead diameter 线径(mm)	Load 负荷(Kg)	Test time 测试时间(sec)
$d \leq 0.5$	0.5	30±1
$0.5 < d \leq 0.8$	1.0	30±1
$0.8 < d \leq 1.2$	2.5	30±1

6、Endurance characteristics 耐久特性

6.1、Load Life 高温负荷寿命

After apply rated voltage for 2000+12/-0 hours at 105±2°C,when the capacitors are restored to 20°C,the capacitors shall meet the following requirements. 在 105±2°C 环境中，连续加载额定电压 2000+12/-0 小时后，待温度恢复到 20°C 进行测量时，电容器应满足以下要求：

Capacitance Change 容量变化率	Within ±20% of initial value 在初始值的±20%以内
Dissipation Factor 损失角	Not more than 200% of specified value 不超过规格值的 200%
Leakage Current 漏电流	Not more than the specified value 不超过规格值

6.2、Shelf life 高温无负荷寿命

After placed at 105±2°C without voltage applied for 1000+12/-0 hours,when the capacitors are restored to 20°C, the capacitors shall meet the following requirements. 在 105±2°C 环境中，无负荷放置 1000+12/-0 小时，待温度恢复至 20°C 进行测量时，电容器应满足以下要求：

Capacitance Change 容量变化率	Within $\pm 20\%$ of initial value 在初始值的 $\pm 20\%$ 以内
Dissipation Factor 损失角	Not more than 200% of specified value 不超过规格值的 200%
Leakage Current 漏电流	Not more than 200% of specified value 不超过规格值的 200%

6.3、Solderability test 焊锡性试验

The following specifications shall be satisfied when the lead wires are tested in solder bath at $250\pm 5^\circ\text{C}$ for 2.5 ± 0.5 seconds, more than 95% of the terminal surface shall be covered with new solder. 当导针在 $250\pm 5^\circ\text{C}$ 的焊锡槽中试验 2.5 ± 0.5 秒后, 95%以上的端子表面应当要被新焊料覆盖。

6.4、Solder Heat Resistance 焊锡耐热性

The following specifications shall be satisfied when the lead wires are tested in solder bath at $265+5/-5^\circ\text{C}$ for $10+1/-1$ seconds. 当导针在 $265+5/-5^\circ\text{C}$ 的焊锡槽中试验 $10+1/-1$ 秒后, 应当满足以下要求:

Capacitance Change 容量变化率	Within $\pm 20\%$ of initial value 在初始值的 $\pm 20\%$ 以内
Dissipation Factor 损失角	Not more than the specified value 不超过规格值
Leakage Current 漏电流	Not more than the specified value 不超过规格值

7、Mounting 安装

The paper separators and the electrolytic-conductive electrolytes in a non-solid aluminum electrolytic capacitor is flammable. Leaking electrolyte on a PC board can gradually erode the copper traces, possibly causing smoke or burning by short-circuiting the copper traces. Verify the following points when designing a PC board. 非固态电容器内的电解纸和电解液都是易燃品。PC板上漏液会逐渐侵蚀铜丝,很可能由于铜丝短路导致冒烟或燃烧。在设计PC板时需验证以下要点:

7.1、Provide the appropriate hole spacing on the PC board to match the terminal spacing of the capacitor. 在PC板上保留适当的孔距以匹配电容器的端子间距。

7.2、Make the following open space over the vent so that the vent can operate correctly. 在防爆阀的上方保留适当空间,以便防爆阀可以正常工作。

Case diameter 铝壳直径	Clearance 间隔
$\phi 6.3 \sim \phi 13 \text{ mm}$	$\geq 2 \text{ mm}$
$\phi 16 \sim \phi 35 \text{ mm}$	$\geq 3 \text{ mm}$
$\geq \phi 40 \text{ mm}$	$\geq 5 \text{ mm}$

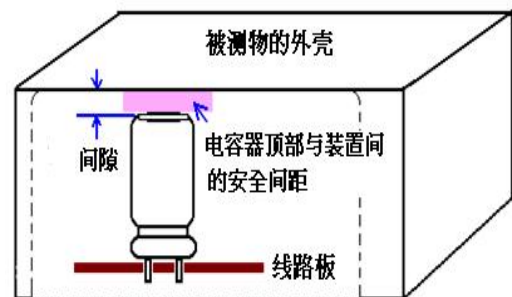

7.3、Do not place any wires or copper traces over the vent of the capacitor. 请不要在电容器的防爆阀上方放置任何电线或铜丝。

7.4、Installing a capacitor with the vent facing the PC board needs an appropriate ventilation hole in PC board. 在安装电容器时，如果防爆阀正对 PC 板，则 PC 板上需要开一个适当的通风孔。

7.5、Do not pass any copper traces beneath the seal side of a capacitor. The trace must pass 1 or 2 mm to the side of the capacitor. 请不要在电容器的封口部下面进行电路配线。如果在电容器附近配线,请确保线路与电容器间隔 1~2mm。

7.6、Avoid placing any heat-generating objects adjacent to a capacitor or even on the reverse side of the PC board. 请不要在电容器周围或 PC 板的背面放置任何发热部件。

7.7、Do not pass any via holes or underneath a capacitor. 请不要从电容器通孔或电容器底部穿过。

7.8、In designing double-sided PC boards, do not locate any copper trace under the seal side of capacitor. 设计双面 PC 板时，请不要在电容器的封口面放置任何铜丝。

7.9、The liquid aluminum electrolytic capacitor can't be reflow soldering, please contact us if you need to do that. 液态铝电解电容器不能进行回流焊，如需进行回流焊请与我司联系。

7.10、For the capacitor that diameter > 13Φ and the Pen-cap that diameter ≤ 13Φ ,it is recommended to be fixed on the PCB with fixed adhesive when installed, so as to enhance their vibration resistance. 直径>13Φ的电容和直径≤13Φ的笔形电容，为增强其抗振动能力，建议安装时用固定胶辅助其固定于 PCB 上。

8、Storage Condition 储存条件

8.1、Aluminum Electrolytic Capacitors should not be stored in high temperatures or where there is a high level of humidity. The suitable storage condition is 5~35℃ and less than 75% in relative humidity. 铝电解电容器不应当储存在高温或高湿的条件下.合适的储存条件为 5~35℃,相对湿度低于 75%。

8.2、Aluminum Electrolytic Capacitors should not be stored in damp conditions such as water, saltwater spray or oil spray. 铝电解电容器不应当储存在潮湿的条件下，如水、盐水喷雾或油雾。

8.3、Do not store Aluminum Electrolytic Capacitors in an environment full of hazardous gas (hydrogen sulfide , sulfurous acid gas, nitrous acid, chlorine gas, ammonium, etc...). 请不要将铝电解电容器存储在一个充满有害气体的环境下(硫化氢、二氧化硫、亚硝酸、氯气、铵气等...).

8.4、Aluminum Electrolytic Capacitors should not be stored under exposure to ozone, ultraviolet rays or radiation. 铝电解电容器储存不应暴露在臭氧、紫外线辐射和射线中。

8.5、If a capacitor has been stored for more than one year under normal temperature (shorter if high

temperature) and it shows increased leakage current, then a treatment by voltage application is recommended. The capacitor which hasn't been treated mustn't be used directly. 如果电容器在常温下储存超过一年(高温条件下不超过一年),出现漏电流上升现象,那么建议对电容器进行加电压处理.未被处理过的电容器不能直接使用。

9、Electrolytic Capacitor Structure 结构图和材料清单

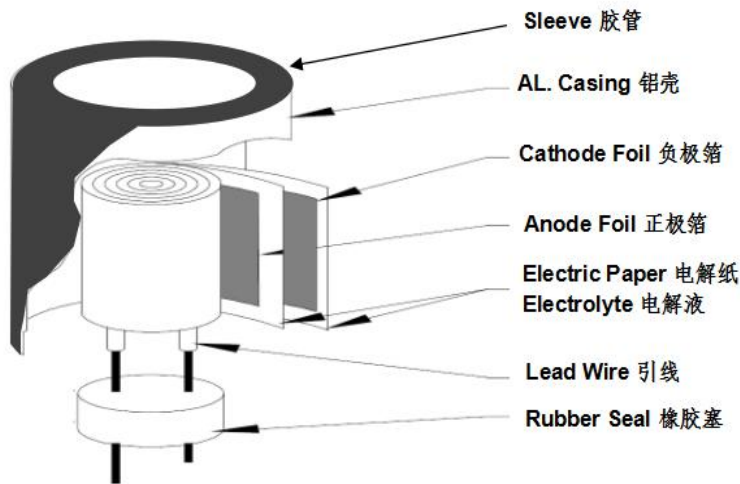

NO.	部件名称	材质/成分	主要供应商厂家
1	正极箔	铝, 纯度 $\geq 99.98\%$	海星、东阳光、众和
2	负极箔	铝, 纯度 $\geq 99.7\%$	冠业、飞乐
3	电解纸	电解电容器纸, 木材纸浆, 棉浆纸, 纤维纸等	凯恩、仙鹤
4	电解液	乙二醇、有机酸盐等有机溶剂	新宙邦、久制
5	引线	铝+镀锡铜钢 CP 线	日辉、益利达
6	橡胶塞	合成橡胶	联华鑫、吉和、城南
7	胶管	PET	云林、启源
8	铝壳	铝, 纯度 $\geq 99.5\%$	奥星、华和

10、Marking 标识

序号	项目
1	商标: UNITED
2	静电容量: 22 μ F
3	工作电压: 50V
4	产品系列: LW
5	最高使用温度: 105 $^{\circ}$ C
6	周期: HC
7	静电容量公差: (M)
8	负极标识
9	胶管: 绿底白字/PET

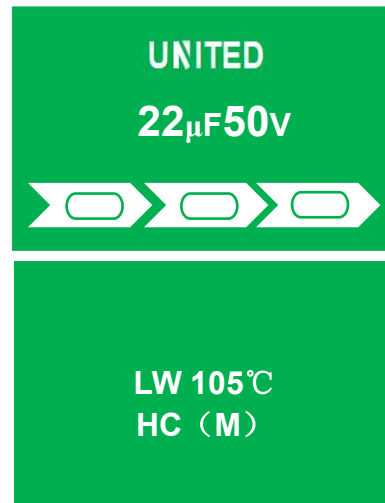

胶管周期版面说明:

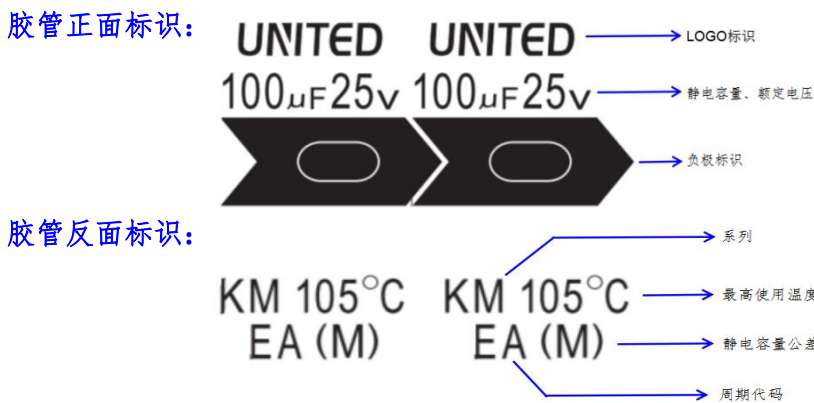

周期标识说明如下:

年份	周期代码			
	第一季度	第二季度	第三季度	第四季度
2020	EA	EB	EC	ED
2021	FA	FB	FC	FD
2022	GA	GB	GC	GD
2023	HA	HB	HC	HD
2024	IA	IB	IC	ID
2025	JA	JB	JC	JD
2026	KA	KB	KC	KD
2027	LA	LB	LC	LD
2028	MA	MB	MC	MD

2029	NA	NB	NC	ND
2030	OA	OB	OC	OD

备注：季度周期分别用 **A/B/C/D** 字母表示；年份依次按照 **A/B/C/D/E/F/G** 递增。

11、Guidelines For Using Aluminum Electrolytic Capacitor 铝电解电容器的使用注意事项

Upon using Aluminum Electrolytic Capacitors, please proper handing and observing to following important points will insure optimum capacitor performance and long life. 为使您获得电解电容器的最佳性能和延长电解电容器的使用寿命，在使用电解电容器器前，请务必阅读本注意事项。

11.1、DC electrolytic capacitors are polarized. 直流电解电容器是有极性的

Make sure of the polarity .The polarity is marked on the body of the capacitor .Application of the reversed voltage cause a short circuit or damage to the capacitor .Use bipolar capacitors when the polarity is not determined or unknown . Note that DC electrolytic capacitors can not be used for AC application. 确定极性，极性标志在电容器的基体上。以免因极性反可能引起电路短路或电容器损坏，当极性不固定或不确定的，使用双极性电容器。注意直流电解电容器不能使用于交流。

11.2、Do not apply voltage greater than rated voltage. 使用电压不要大于额定电压

If a voltage exceeding the rated voltage is applied ,the leakage current will increase , which damage the capacitor . Recommended working voltage is 70 to 80 percent of tatted voltage . Using capacitors at recommended working voltage prolongs capacitor life. 使用电压大于额定电压，漏电流会增大，可能损坏电容器。建议工作电压为额定电压的百分之七十~八十，电容器在建议的工作电压下使用可延长电容器的寿命。

11.3、Do not allow excessive ripple current through the capacitor. 不要使过量的纹波电流通过电容器

The flow of ripple current over permissible ripple current will cause heat of the capacitor ,which may decrease the capacitance and damage the capacitor .ripple current on the capacitor must be at or bellow allowable level. 流过电容器的纹波电流超过许可值，将会引起电容器发热，电容量减少，损害电容器。通过电容器的纹波电流不要大于允许值。

11.4、Use specially designed capacitors for the circuits where charge and discharge are frequency repeated. 快速的充放电电路中，使用专门设计的电容器

In the circuit subjected to rapid charge cycles ,capacitors may be damaged ,its life may be shortened by capacitance decrease ,heat rise , ect . Be sure and use special capacitors in these applications. 在经受快速的周期性充放电电路中，电容器可能受损害，它的寿命因容量下降、温升等原因而缩短，在这种电路中，一定要使用专门设计的电容器。

11.5、Operating temperature range. 工作温度范围

The characteristics of capacitors change with the operating temperature .The capacitance and leakage current increase and decrease at higher temperatures . The capacitance and leakage current decrease and $\tan\delta$ increase lower temperature .Usage at lower temperature will ensure longer life. 电容器的特性随工作温度而变化，在温度较高的情况下，容量、漏电流增大，减少；在低温情况下，容量和漏电流下降，增大。电容器在较低的温度下使用会确保延长寿命。

11.6、Check operating frequency. 核对工作频率

The capacitance of electrolytic capacitors is usually measured at 100Hz or 120Hz . However ,remember that capacitance decrease and $\tan\delta$ increase as the applied frequency becomes higher whereas the ambient temperature becomes higher. 电解电容器的容量通常是在 100Hz 或 120Hz 下测得的。然而要记住容量随频率的升高而下降， $\tan\delta$ 随频率的升高而增大，并使周围温度升高。

11.7、Apply rated DC voltage treatment to the capacitors which have been stored for a long time. 长时间存放的电容器，在使用前加额定直流电压处理

Long periods of storage have virtually no effect on a capacitor's capacitance and $\tan\delta$.Such periods tend however ,to increase leakage current and decrease withstand voltage .After removing capacitors from long-duration storage ,First apply a gradually increasing DC voltage to rated voltage and then use them. 长时间的存放，实际对电容器的容量和 $\tan\delta$ 没有多大的影响，然而往往会使漏电流增大，耐压降低。长时间存放后的电容器处理，首先逐渐施加直流电压至额定电压，然后再使用

11.8、The capacitor case is not insulated from the cathode terminal. 电容器外壳与阴极端是不绝缘的

The capacitor's case and cathode terminal connect through the electrolyte .If the case is to be completely insulated ,that insulation must be at the capacitor's mounting point. 电容器外壳与阴极端是通过电解液连接的，如果电容器的外壳必须与线路绝缘，则电容器的安装位置处，一定要采取绝缘措施。

11.9、Do not apply excessive force to the terminals and leads. 电容器的端子或引线上不要施加过大的力

The excessive strong force applied to the terminals and lead wires may cause leads to break or terminals to separate and ,in turn ,cause the internal contact to fail. 过大的力施加到端子和引线上，可能引起引线的断裂或端子分裂，转而会引起内部连接的破坏。

12、Others 其它

12.1、All the United capacitors, which are authenticated by the SGS, and the test report shows that the inspection results of Hexavalent Chromium VI(Cr(VI)), Cadmium (Cd), Mercury (Hg), Lead
Room 201, Building 6, Yinmandi High-tech Industrial Park, No. 2, Qinghu Minyingyuan Road, Qishi Town,
Dongguan City, Guangdong Province 广东省东莞市企石镇清湖民营园路2号银满地高新产业园6号楼201室

(Pb), Polybrominated Biphenyls (PBBs), Polybrominated Diphenyl Ether (PBDEs), Bis(2-ethylhexyl) phthalate (DEHP), Dibutyl phthalate (DBP), Butyl benzyl phthalate (BBP), Diisobutyl phthalate (DIBP), comply with the RoHS requirements. 怡德所有电容器经 SGS 认证测试报告中所检测的六价铬(Cr+6), 镉(Cd), 汞 (Hg), 铅(Pb), 多溴联苯(PBBs), 多溴联苯醚(PBDEs), 邻苯二甲酸二(2-乙基己基)酯(DEHP), 邻苯二甲酸二丁酯(DBP), 邻苯二甲酸甲基丁酯(BBP), 邻苯二甲酸二异丁酯(DIBP), 均符合 RoHS 要求.

12.2、Satisfied characteristic JIS C 5101. 符合 JIS C 5101 特性.

12.3、Aluminum Electrolytic Capacitors may be damaged by corrosion which is caused by any halogenated hydrocarbon solvents. Please let us know in advance the solvent name and conditions for your PCB cleaning. 铝电解电容器可能会被卤化烃类溶剂导致的腐蚀而损坏。请让我们事先了解贵司印刷电路板使用的清洗剂的名称和清洗条件。

13、Lead processing type and Taping 导针加工类型和编带

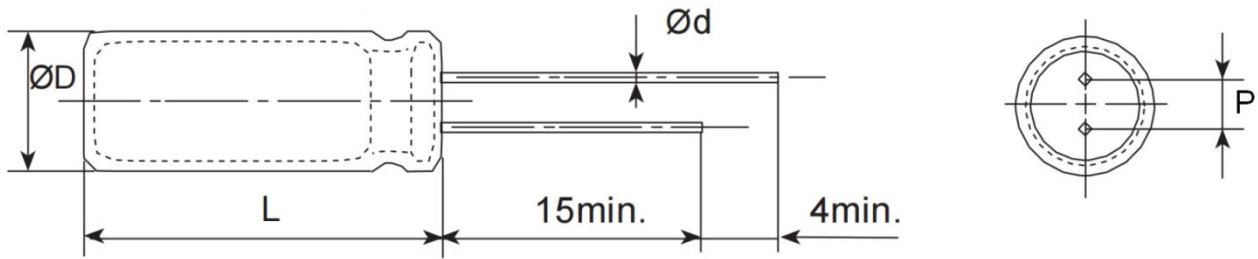

部位名称	直径 $\varnothing D$	高度 L	引线线径 $\varnothing d$	引线间距 P
标准 (mm)	5	11	0.5	2.0
公差 (mm)	± 0.5	± 1.5	± 0.05	± 0.5