

1. Description

The CSL05J2U is a low capacitance TVS (Transient Voltage Suppressor) array designed to protect high speed data interfaces. It has been specifically designed to protect sensitive electronic components which are connected to data and transmission lines from over-stress caused by ESD (Electrostatic Discharge).

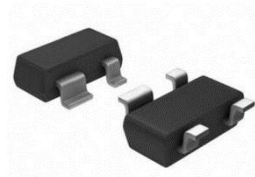

2. Features

- IEC 61000-4-2 (ESD)
 - ±20kV Contact Discharge
 - ±20kV Air Discharge
- IEC 61000-4-5 (Lightning)
 - 8A (8/20us)
- IEC 61000-4-4 EFT Protection
 - 40A (5/50ns)
- Halogen free and RoHS compliant
- Protects two I/O lines and one V_{CC} line
- Low clamping voltage
- Low capacitance
- Low leakage current

3. Mechanical Data

- Projection TV & Monitors
- Digital Visual Interface (DVI)
- USB 2.0
- Set-top box
- IEEE 1394 Firewire Ports
- Notebooks & Handhelds
- Flat Panel Displays
- PCI Express

4. Ordering Information

Part Number	Package	Marking	Material	Packing	Quantity per reel	Flammability Rating	Reel Size
CSL05J2U	SOT-143	R05	Halogen free	Tape & Reel	3,000 PCS	UL 94V-0	7 inches

Table-1 Ordering information

5. Pin Configuration and Functions

Pin	Name	Description	Outline	Circuit Diagram
1	GND	Connect to GND		
2	IO	Connect to IO		
3	IO	Connect to IO		
4	Vcc	Connect to Vcc		

Table-2 Pin configuration

6. Absolute Maximum rating

Over operating free-air temperature range (unless otherwise noted)

Parameters	Symbol	Min.	Max.	Unit
Peak pulse power (tp=8/20us)@25°C	P_{pk}	-	120	W
Peak pulse current (tp=8/20us)@25°C	I_{PP}	-	8	A
ESD (IEC61000-4-2 air discharge) @25°C	V_{ESD}	-	±15	kV
ESD (IEC61000-4-2 contact discharge) @25°C	V_{ESD}	-	±15	kV
Junction temperature	T_J	-	125	°C
Operating temperature	T_{OP}	-40	125	°C
Storage temperature	T_{STG}	-55	150	°C
Lead temperature	T_L	-	260	°C

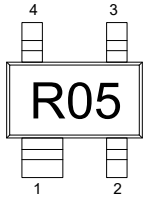
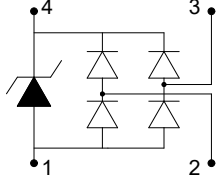
Table-3 Absolute Maximum rating

7. Electrical Characteristics

At TA = 25°C unless otherwise noted

Parameter	Symbol	Conditions	Min.	Typ.	Max.	Units
Reverse Stand-off Voltage	V_{RWM}	Any I/O pin to GND			5	V
Reverse Breakdown Voltage	V_{BR}	IT=1mA Any I/O pin to GND	6			V
Reverse Leakage Current	I_R	$V_{RWM}=5V$			1	uA
Clamping Voltage	V_C	$I_{PP}=1A$; $t_p=8/20\mu s$ Any I/O pin to GND		10		V
Clamping Voltage	V_C	$I_{PP}=5A$; $t_p=8/20\mu s$ Any I/O pin to GND		15		V
Clamping Voltage	V_C	$I_{PP}=8A$; $t_p=8/20\mu s$ Any I/O pin to GND		17		V
Junction Capacitance	C_J	$V_R=0V$; $f=1MHz$ I/O pin to I/O pin		0.6		pF
Junction Capacitance	C_J	$V_R=0V$; $f=1MHz$ I/O pin to GND		1.2		pF

Table-4 Electrical Characteristics

8. Typical Application

Typical Interface Application

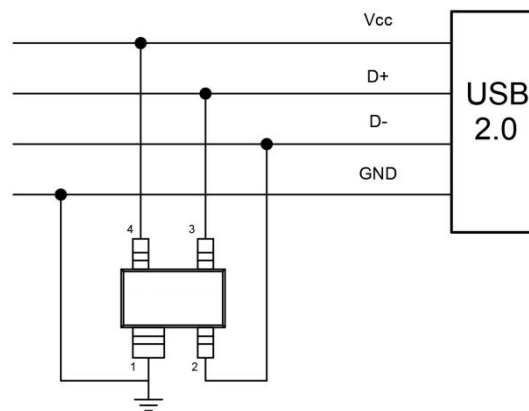

9. Ratings and Characteristic Curves (TA = 25°C unless otherwise noted)

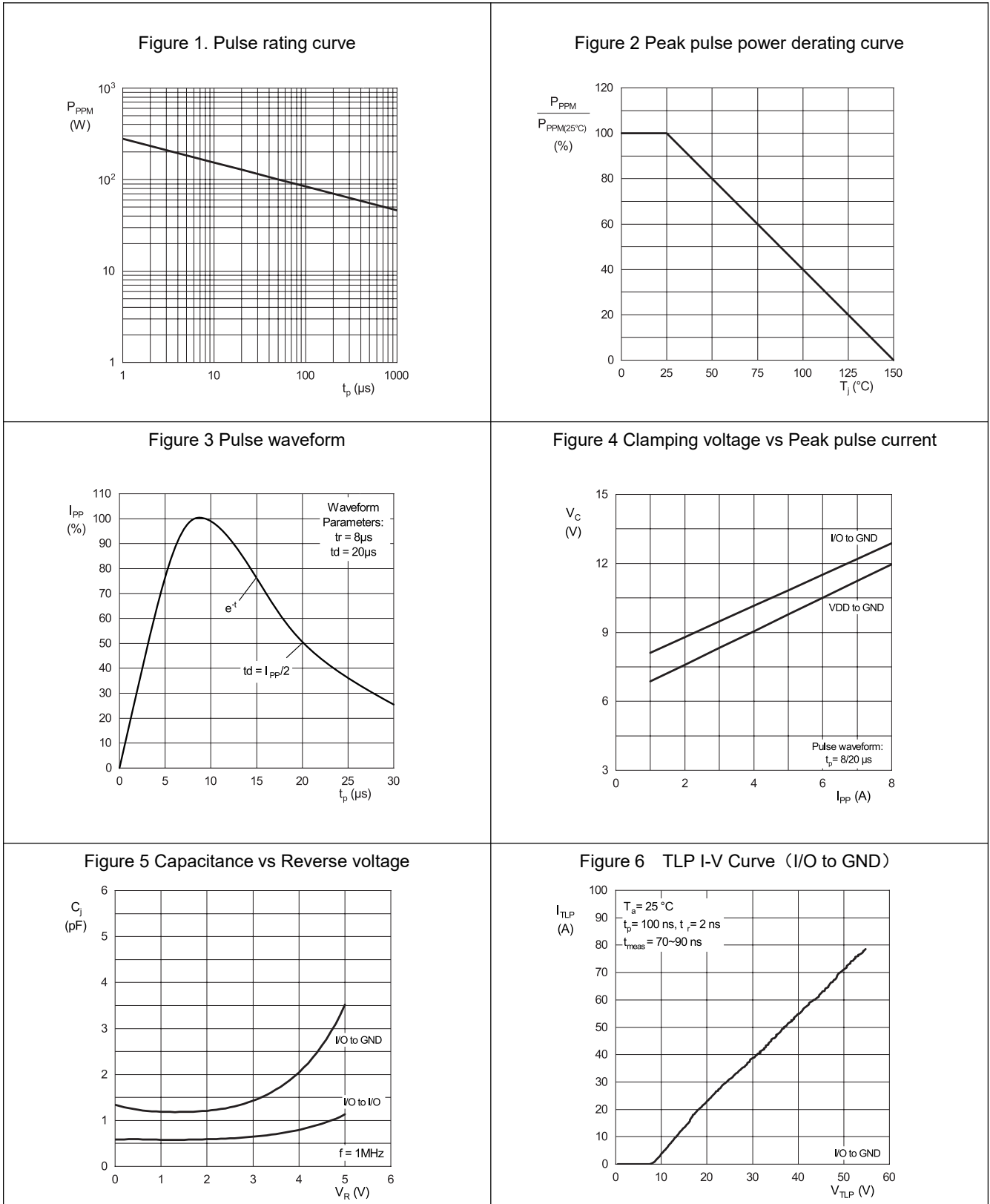

10.Dimension

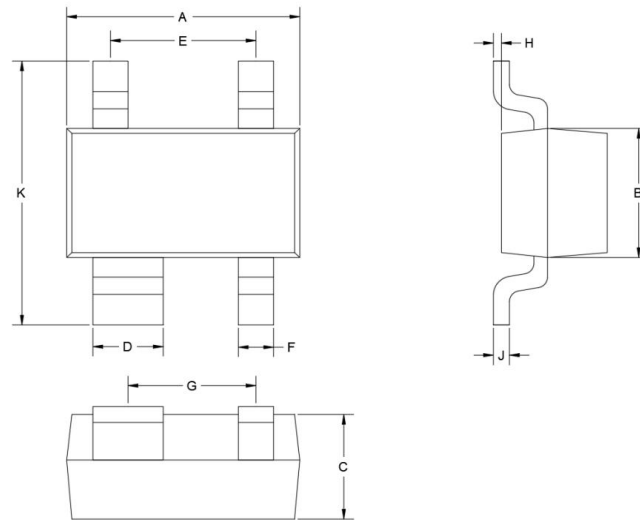

All dimension in millimeters

Symbol	A	B	C	D	E	F	G	H	J	K
Min	2.70	1.10	0.90	0.75	1.80	0.30	1.59	0.02	0.05	2.20
Max	3.10	1.50	1.20	0.95	2.00	0.50	1.79	0.10	0.15	2.60

Table-5 Product dimensions

11.Recommended Land Pattern

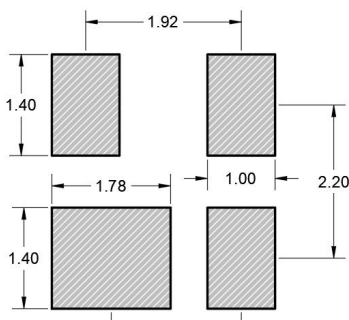

Note:

1. Controlling dimension: in millimeters
2. General tolerance: $\pm 0.05\text{mm}$
3. The pad layout is for reference only

12.Revision history of Specification

Version	Change Items	Effective Date
1.0	Initial Release	9-Jun-2022