

Description

The SLVU2.8-8BTG is designed to protect voltage sensitive components from ESD and transient voltage events. Excellent clamping capability, low leakage, and fast response time. The SLVU2.8-8BTG is suited for using in 10/100/1000M Ethernet.

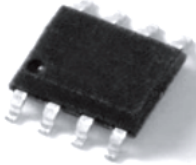

Features

- ◆ IEC 61000-4-2 (ESD)
 - ±30kV Contact Discharge
 - ±30kV Air Discharge
- ◆ IEC 61000-4-5 (Lightning)
 - 30A (8/20us)
- ◆ IEC 61000-4-4 EFT Protection
 - 40A (5/50ns)
- ◆ Halogen free and RoHS compliant
- ◆ Protects 4 line pairs
- ◆ Transient protection for high-speed data lines
- ◆ Low clamping voltage
- ◆ Low leakage current

Mechanical Characteristics

- ◆ SO-8
- ◆ ROHS/ Compliant
- ◆ Halogen free
- ◆ Molding compound flammability rating: UL 94V-0
- ◆ Marking: Part number
- ◆ Packing: Tape and Reel per EIA 481

Applications

- ◆ Base station
- ◆ 10/100/1000M Ethernet
- ◆ WAN/LAN equipment
- ◆ Desktop/Notebooks/Servers
- ◆ Low voltage interfaces

Pin Configuration

Marking	Outline	Circuit Diagram
		<p style="text-align: center;">Each line</p>

Ordering Information

Part Number	Package	Marking	Packing	Reel Size
SLVU2.8-8BTG	SO-8	See above showed	2500/Tape & Reel	13 inch

Absolute Maximum Ratings ($T_A=25^\circ\text{C}$ unless otherwise specified)

Parameters	Symbol	Min.	Max.	Unit
Peak pulse power ($t_p=8/20\mu\text{s}$)@ 25°C	P_{pk}	-	600	W
Peak pulse current ($t_p=8/20\mu\text{s}$)@ 25°C	I_{pp}	-	30	A
ESD (IEC61000-4-2 air discharge) @ 25°C	V_{ESD}	-	± 30	kV
ESD (IEC61000-4-2 contact discharge) @ 25°C	V_{ESD}	-	± 30	kV
Junction temperature	T_J	-	125	$^\circ\text{C}$
Operating temperature	T_{OP}	-55	125	$^\circ\text{C}$
Storage temperature	T_{STG}	-55	150	$^\circ\text{C}$
Lead temperature	T_L	-	260	$^\circ\text{C}$

Electrical Characteristics ($T_A=25^\circ\text{C}$ unless otherwise specified)

Parameter	Symbol	Conditions	Min.	Typ.	Max.	Units
Reverse Stand-off Voltage	V_{RWM}				2.8	V
Pouch-Through Voltage	VPT	2uA	3.0			
Snap-Back Voltage	V_{BR}	$I_{sb}=50\text{mA}$	2.8			V
Reverse Leakage Current	I_R	$V_{RWM}=2.8\text{V}$ each line		0.1	1	μA
Clamping Voltage	V_C	$I_{pp}=1\text{A}$; $t_p=8/20\mu\text{s}$			6	V
Clamping Voltage	V_C	$I_{pp}=5\text{A}$; $t_p=8/20\mu\text{s}$			8	V
Clamping Voltage	V_C	$I_{pp}=10\text{A}$; $t_p=8/20\mu\text{s}$			10	V
Clamping Voltage	V_C	$I_{pp}=30\text{A}$; $t_p=8/20\mu\text{s}$			20	V
Junction Capacitance	C_J	Each line; $V_R=0\text{V}$; $f=1\text{MHz}$		2		pF



Typical Performance Characteristics ($T_A=25^{\circ}\text{C}$ unless otherwise Specified)

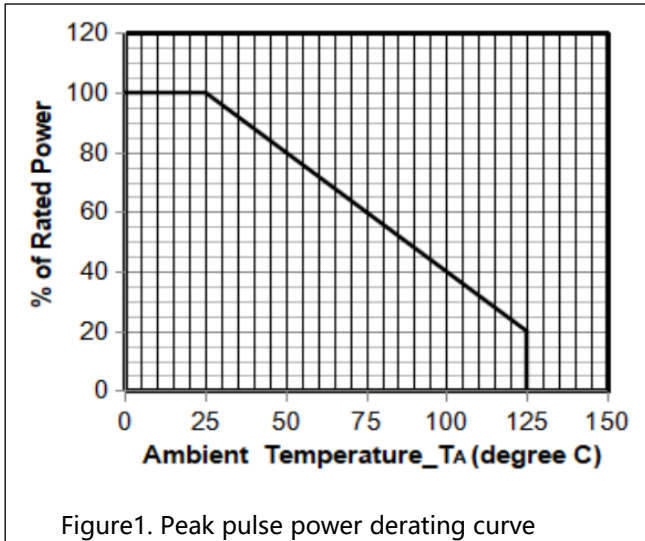

Figure1. Peak pulse power derating curve

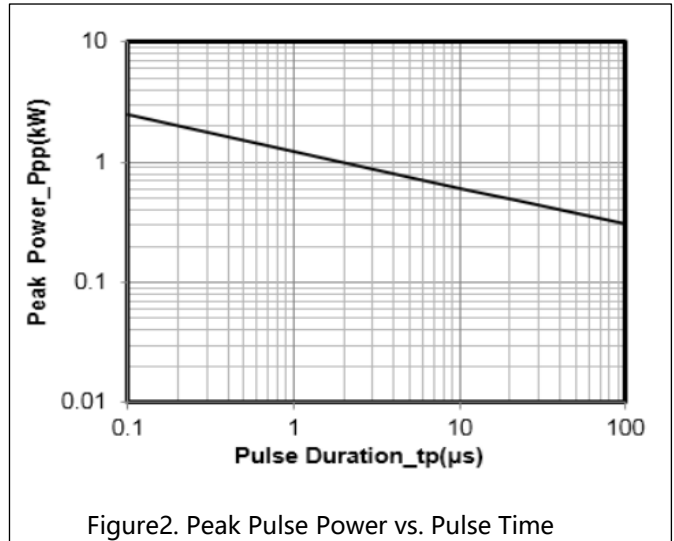

Figure2. Peak Pulse Power vs. Pulse Time

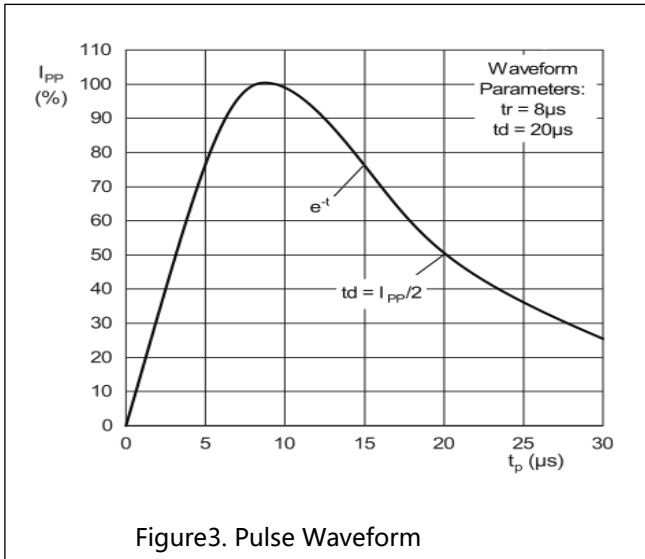

Figure3. Pulse Waveform

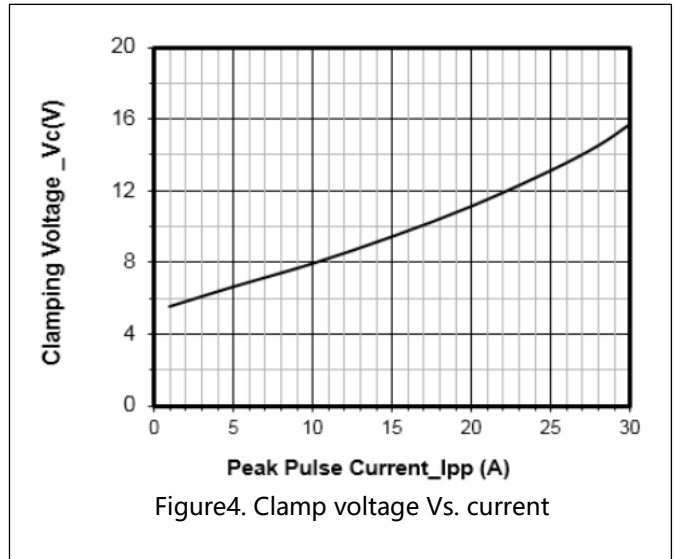

Figure4. Clamp voltage Vs. current

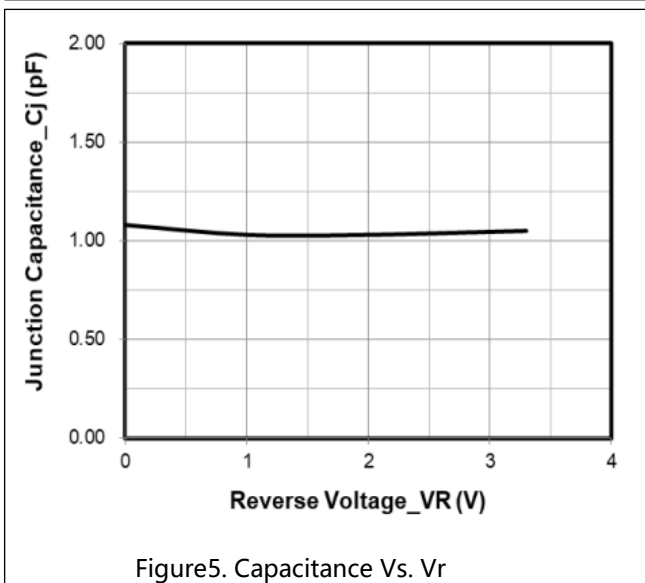
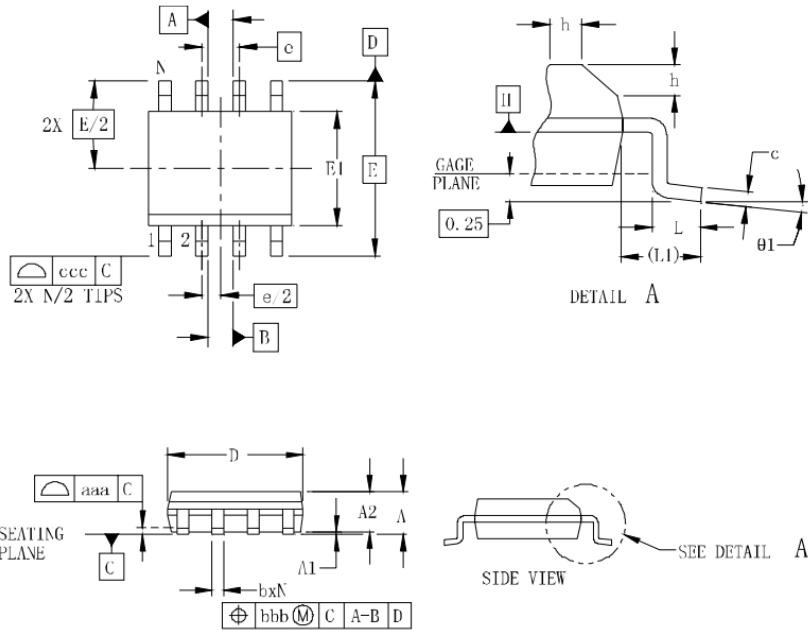

Figure5. Capacitance Vs. Vr

Applications Information

Typical Ethernet application

Package Outline Drawing



SY M	DIMENSIONS					
	MILLIMETERS			INCHES		
	MIN	NOM	MAX	MIN	NOM	MAX
A	1.35		1.75	0.053		0.069
A1	0.10		0.25	0.004		0.010
A2	1.25		1.65	0.049		0.065
b	0.31		0.51	0.012		0.020
c	0.17		0.25	0.007		0.010
D	4.80	4.90	5.00	0.189	0.193	0.197
E1	3.80	3.90	4.00	0.150	0.154	0.157
E	6.00 BSC			0.236 BSC		
e	1.27 BSC			0.050 BSC		
h	0.25		0.50	0.010		0.020
L	0.40	0.72	1.04	0.016	0.028	0.041
L1	(1.04)			(0.041)		
N	8			8		
theta1	0°		8°	0°		8°
aaa	0.10			0.004		
bbb	0.25			0.010		
ccc	0.20			0.008		

Recommended Land Pattern

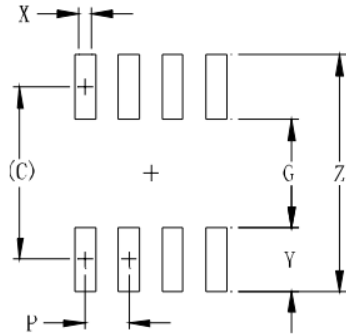

SYM	DIMENSIONS	
	MILLIMETERS	INCHES
C	(5.20)	0.205
G	3.00	0.118
P	1.27	0.050
X	0.60	0.024
Y	2.20	0.087
Z	7.40	0.291

Revision history of Specification

Version	Change Items	Effective Date
1.0	Initial Release	13-Aug-2021