

Description

The CSHXXE2B is designed to protect voltage sensitive components from ESD and transient voltage events. Excellent clamping capability, low leakage, and fast response time. The CSHXXE2B is suited for using in computers, printers, business machines, communication systems, medical equipment and other applications.



Mechanical Characteristics

- SOT-23
- ROHS/ Compliant
- Halogen free
- Molding compound flammability rating: UL 94V-0
- Marking: Part number
- Packing: Tape and Reel per EIA 481

Features

- IEC 61000-4-2 (ESD)
 - $\pm 30\text{kV}$ Contact Discharge
 - $\pm 30\text{kV}$ Air Discharge
- IEC 61000-4-5 (Lightning)
 - 4A~24A (8/20us)
- IEC 61000-4-4 EFT Protection
 - 40A (5/50ns)
- Halogen free and RoHS compliant
- Protects two channels I/O line
- Low leakage current

Applications

- Cell Phone Handsets and Accessories
- Microprocessor based equipment
- Personal Digital Assistants
- Notebooks / Desktops / Servers
- Portable Instrumentation
- Network, telecom
- Switch Systems
- CAN Bus

Dimensions and Pin Configuration

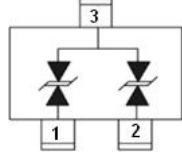
Pin	Name	Description	Circuit Diagram
1-3	IO1	Connect to IO	
2-3	IO2	Connect to IO	

Ordering Information

Part No.	Package	Material	Packing	Quantity per reel	Flammability	Reel Size
CSHxxE2B	SOT-23	Halogen free	Tape&Reel	3000PCS	UL 94V-0	7 inches

Absolute Maximum Ratings ($T_A=25^{\circ}\text{C}$ unless otherwise specified)

Parameters	Symbol	Min.	Max.	Unit
Peak pulse power ($t_p=8/20\mu\text{s}$)@25°C	P_{pk}	-	350	W
ESD (IEC61000-4-2 air discharge) @25°C	V_{ESD}	-	±30	kV
ESD (IEC61000-4-2 contact discharge) @25°C	V_{ESD}	-	±30	kV
Junction temperature	T_J	-	125	°C
Operating temperature	T_{OP}	-55	150	°C
Storage temperature	T_{STG}	-55	150	°C
Lead temperature	T_L	-	260	°C

Electrical Characteristics ($T_A=25^\circ\text{C}$ unless otherwise specified)

PART NUMBER	DEVICE MARKING	V_R (V) (max.)	V_B (V) (min.)	I_T (mA)	$V_C@1A$ (V) (max.)	V_C (V)		I_R (μA) (max.)	C_T (pF) (max.)
						(max.)	(@A)		
CSH03E2B	C03	3.3	4.5	1	8.5	21	24	1	135
CSH05E2B	C05	5.0	6.0	1	9.8	22	24	1	120
CSH08E2B	C08	8.0	8.5	1	13.4	24	18	1	110
CSH12E2B	C12	12.0	13.3	1	19.0	35	20	1	70
CSH15E2B	C15	15.0	16.5	1	24.0	38	10	1	40
CSH18E2B	C18	18.0	20.0	1	29.0	45	8	1	35
CSH24E2B	CB2	24.0	26.7	1	43.0	52	7	1	30
CSH36E2B	DB2	36.0	38.0	1	60.0	75	3	1	25

Typical Performance Characteristics ($T_A=25^\circ\text{C}$ unless otherwise Specified)

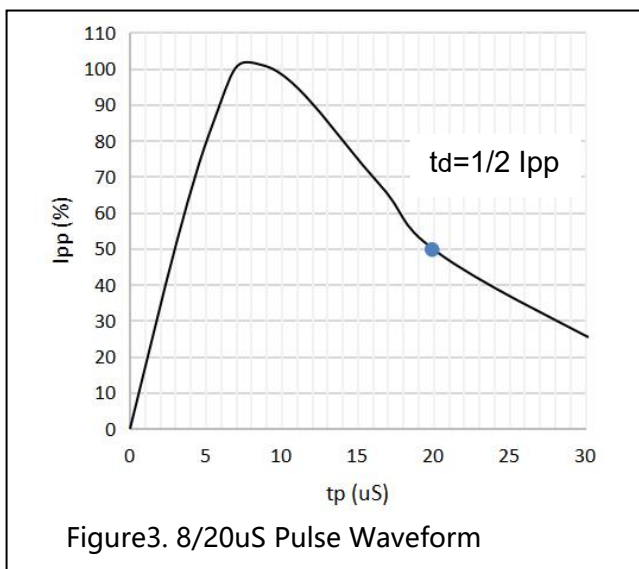
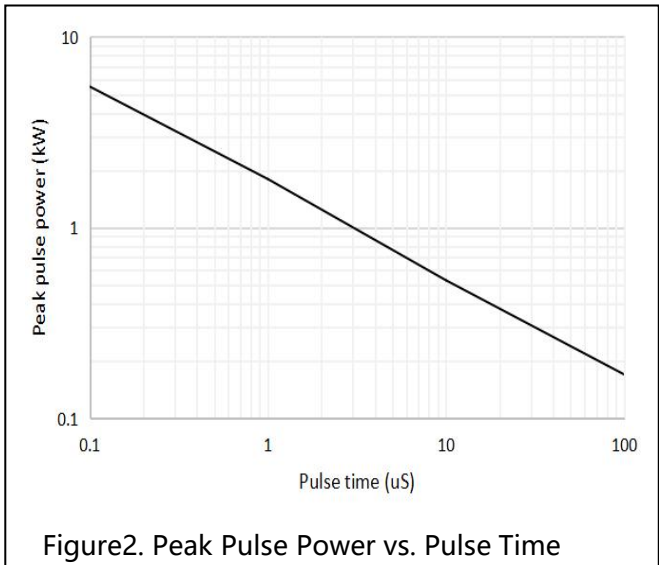
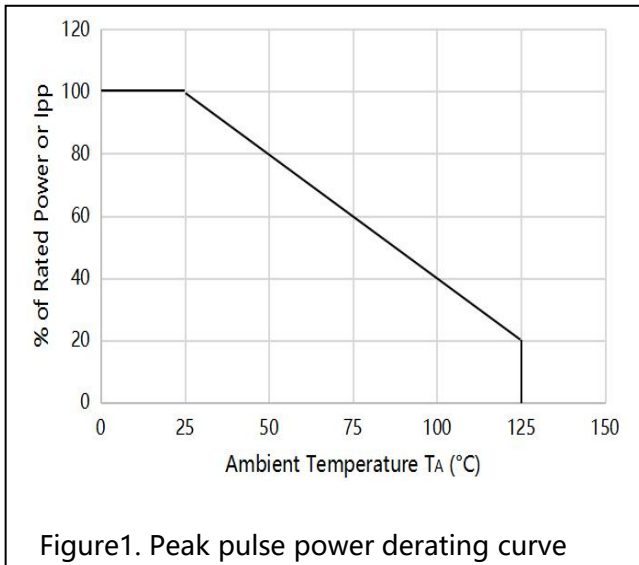

Applications Information

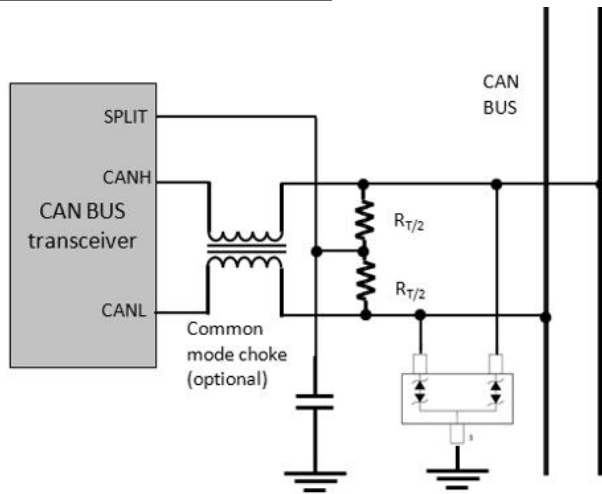
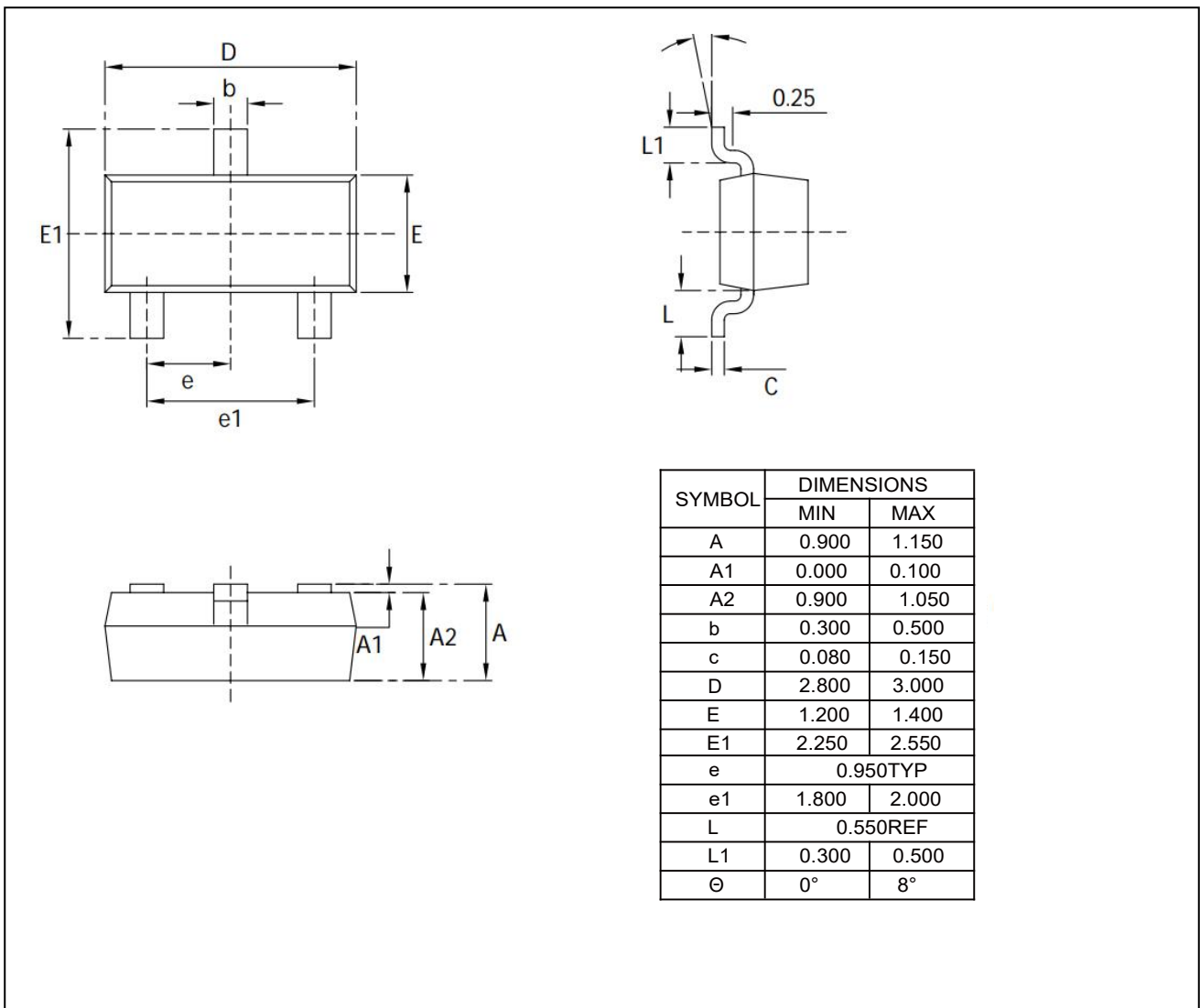

Figure4. CAN Bus protection CSH24E2B

Package Outline Drawing

Unit: mm, tolerance +/-0.05mm



Recommended Land Pattern

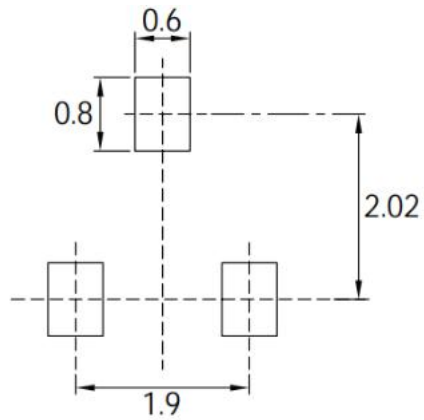

Note:

1. Controlling dimension: in millimeters
2. General tolerance: $\pm 0.05\text{mm}$
3. The pad layout is for reference only