

版次	变更摘要	日期	序号	品名	材质
0			①	5557双排直针2代WTB胶芯	PA66 UL94V-2 白色
1			②	5557双排直针WTB端子	铜合金/表面镀锡

- 技术指标:
1. 温度范围:  $-25^{\circ}\text{C} \sim 85^{\circ}\text{C}$ .
  2. 额定电压: 250V AC, DC.
  3. 耐电压: 1500V AC/minute.
  4. 接触电阻:  $\leq 20\text{m}\Omega$ .
  5. 绝缘电阻:  $\geq 1000\text{M}\Omega$ .
  6. 额定电流: 5A AC, DC.

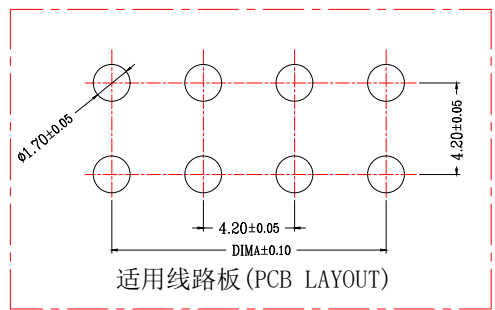
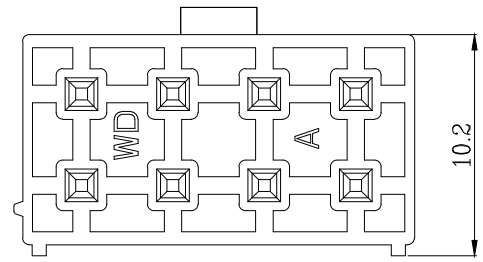
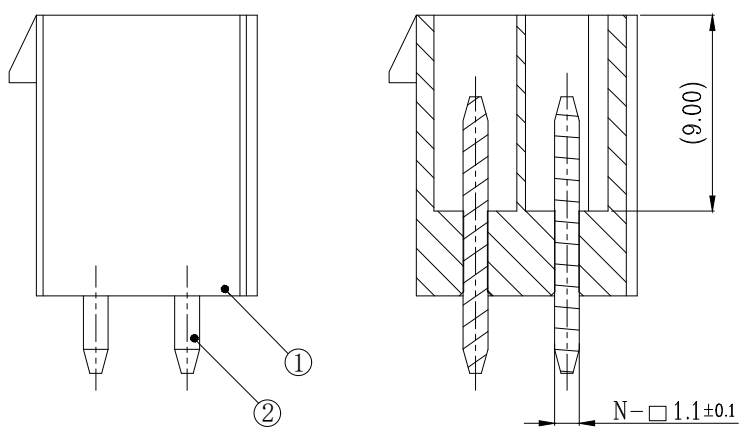
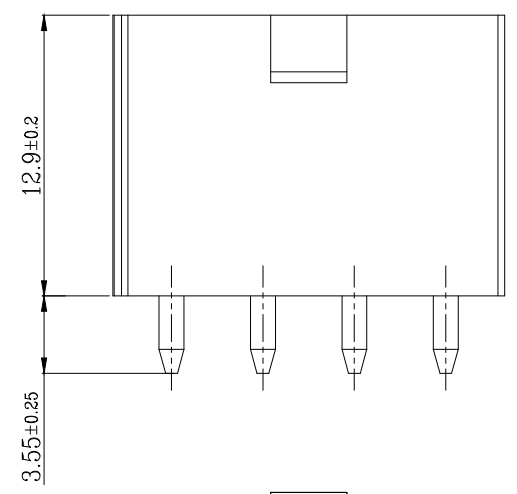
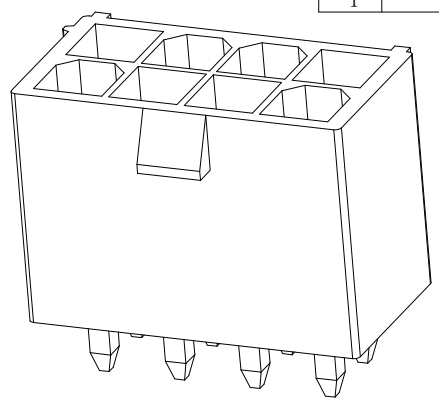
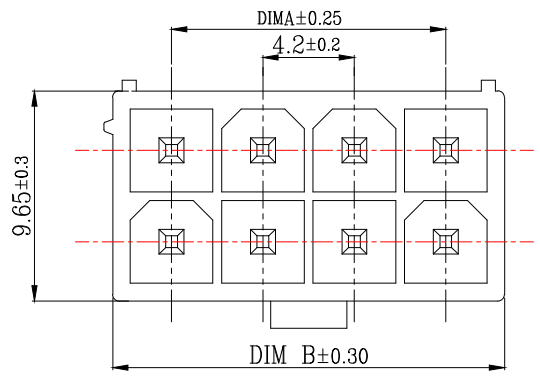

CKT	DIM A	DIM B
1	/	5.40
2	4.20	9.60
3	8.40	13.80
4	12.60	18.00
5	16.80	22.20
6	21.00	26.40
7	25.20	30.60
8	29.40	34.80
9	33.60	39.00
10	37.80	43.20
11	42.00	47.40
12	46.20	51.60

兆星精密电子 (深圳) 有限公司

品名 (TITLE)	5557双排直针WTB-2代	制图 (DR)	
料号 (DWG.NO)	ZX-5557-4.2-2-6PZZ	校对 (CHKD)	
比例 (SCALE)	1:1	审核 (APPD)	
单位 (UNITS)	mm	张数 (SHEET)	1 OF 2
		SIZE	A4
		REV	A



一般公差 (TOLERANCE)  
 X: ±.50 XX ±.10  
 .X ±.20 .XXX ±.05  
 ANGLES ±1°



一般公差 (TOLERANCE)  
 X: ±.50    .XX ±.10  
 .X ±.20    .XXX ±.05  
 ANGLES    ±1°

兆星精密电子 (深圳) 有限公司

品名 (TITLE) 5557双排直针WTB-2代		制图 (DR)	
料号 (DWG.NO) ZX-5557-4.2-2-6PZZ		校对 (CHKD)	
比例 (SCALE) 1:1		单位 (UNITS) mm	张数 (SHEET) 2 OF 2
		审核 (APPD)	SIZE A4
			REV A