



## ABS01 THRU ABS10

VOLTAGE RANGE

100 to 1000 Volts

CURRENT

1.0 Ampere

## Features

- Glass passivated chip junction
- Ideal for surface mounted applications
- Low leakage
- High forward surge current capability
- High temperature soldering guaranteed:260°C/10 seconds at terminals

ABS



## Mechanical Data

- Case: Molded plastic body
- Epoxy: UL94V-0 rate flame retardant
- Polarity: Molded on body
- LeadP: Plated terminals solderable per MIL-STD-202E method 208C
- Weight: 0.003 ounce, 0.10 grams

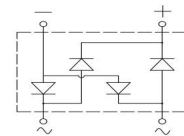
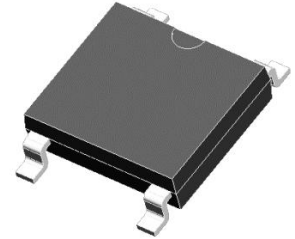

## Maximum Ratings and Electrical Characteristics

- Ratings at 25°C ambient temperature unless otherwise specified
- Single Phase, half wave, 60Hz, resistive or inductive load
- For capacitive load derate current by 20%

TYPE NUMBER	SYMBOLS	ABS01	ABS02	ABS04	ABS06	ABS08	ABS10	UNIT
Maximum Reverse Peak Repetitive Voltage	$V_{RRM}$	100	200	400	600	800	1000	Volts
Maximum RMS Voltage	$V_{RMS}$	70	140	280	420	560	700	Volts
Maximum DC Blocking Voltage	$V_{DC}$	100	200	400	600	800	1000	Volts
Maximum Average Forward Rectified Output Current, 0.06" (1.5mm) lead length at $T_L=100^\circ\text{C}$	$I_{(AV)}$	1.0						Amps
Peak Forward Surge Current 8.3ms single half sine wave superimposed on rated load (JEDEC Method)	$I_{FSM}$	30						Amps
Peak Forward Surge Current 1.0ms single half sine wave superimposed on rated load (JEDEC Method)	$I_{FSM}$	80						
Rating for Fusing ( $t < 8.3\text{ms}$ )	$I^2t$	3.7						$\text{A}^2\text{s}$
Maximum Instantaneous Forward Voltage drop Per Bridge element 1.0A	$V_F$	1.1						Volts
Maximum Reverse Current at rated DC blocking voltage per element	TA=25°C	5						$\mu\text{Amps}$
	TA=125°C	50						
Typical Junction Capacitance <sup>(NOTE 1)</sup>	$C_j$	25						pF
Typical Thermal Resistance <sup>(NOTE 2)</sup>	$R_{\theta JA}$	70						$^\circ\text{C}/\text{W}$
Operating and Storage Temperature Range	$T_J, T_{STG}$	(-55 to +150)						$^\circ\text{C}$

Notes:

1. Measured at 1.0MHz and applied reverse voltage of 4.0 Volts.
2. Unit mounted on P.C.B. with 0.033"×0.043"(1.00mm×1.30mm) copper pads.



### Ratings and Characteristic Curves ( $T_A=25^\circ\text{C}$ unless otherwise noted)

#### F1G.1-FORWARD CURRENT DERATING CURVE

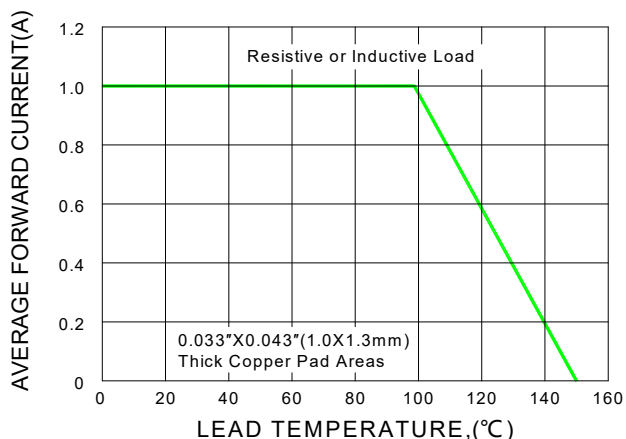

#### F1G.2-MAXIMUM NON-REPETITIVE PEAK FORWARD SURGE CURRENT

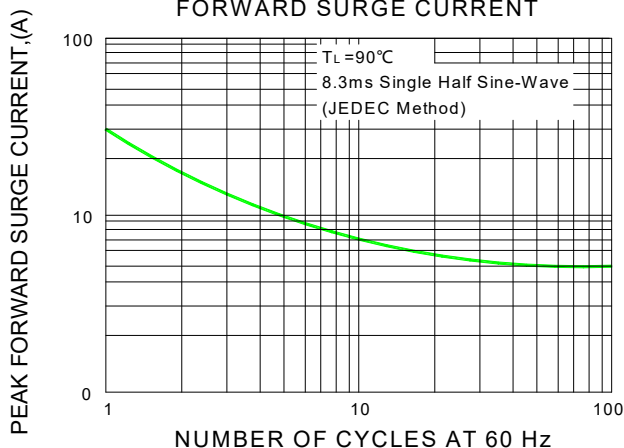

#### F1G.3-TYPICAL INSTANTANEOUS FORWARD CHARACTERISTICS

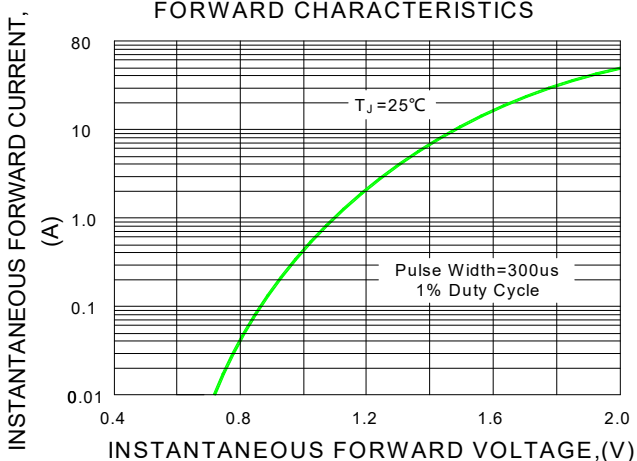

#### F1G.4-TYPICAL REVERSE CHARACTERISTICS

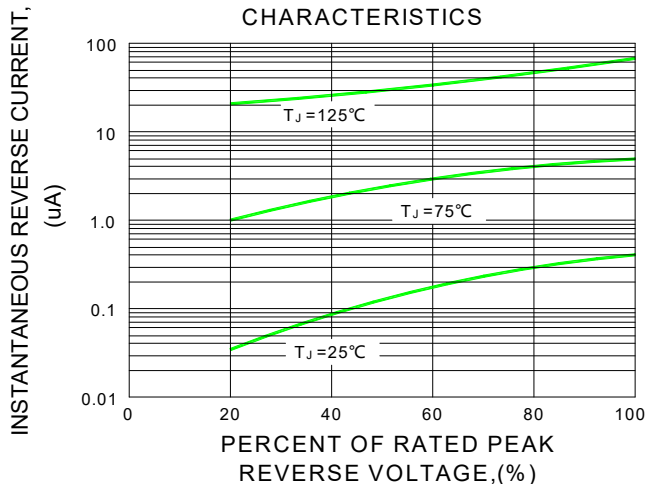

#### F1G.5-TYPICAL JUNCTION CAPACITANCE

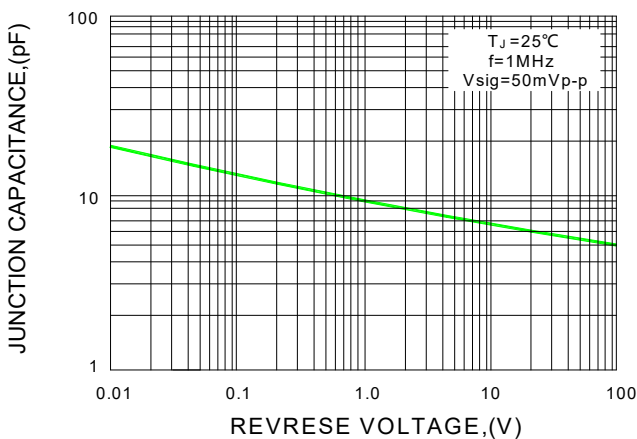



# Surface mounted rectifier bridge reactor

ABS01 THRU ABS10

VOLTAGE RANGE 100 to 1000 Volts  
CURRENT 1.0 Ampere

Package Outline Dimensions in inches (millimeters)

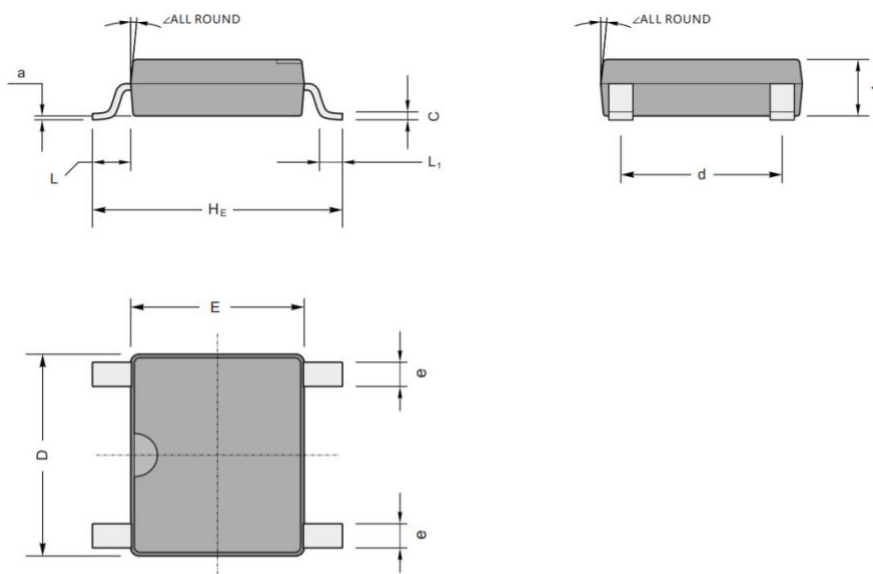

UNIT		A	C	D	E	HE	d	e	L	L1	a	∠
mm	max	1.5	0.25	5.2	4.5	6.5	4.2	0.7	0.95	0.6	0.2	7°
	min	1.3	0.15	4.9	4.2	6.0	3.8	0.5				
mil	max	59	8.7	205	177	256	165	28	37	24	8	
	min	51	5.9	193	166	236	150	20				



# Surface mounted rectifier bridge reactor

ABS01 THRU ABS10

VOLTAGE RANGE 100 to 1000 Volts  
CURRENT 1.0 Ampere

## Packing Requirments

- PS black anti-static carrier tape packing

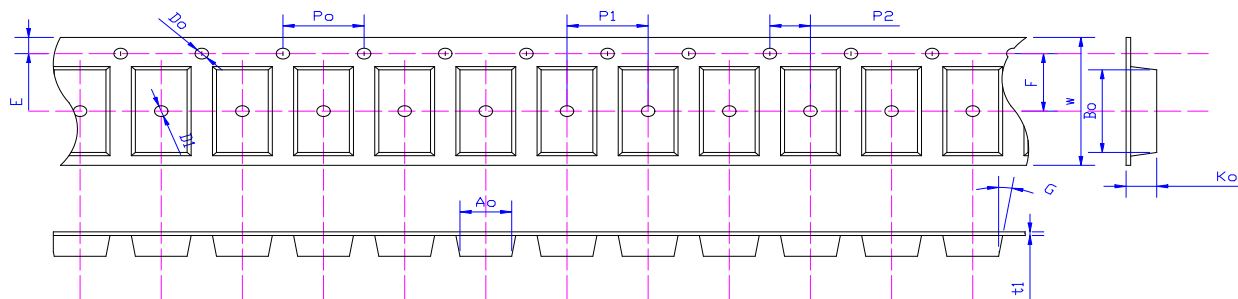

Specifications	Ao	Bo	Ko	Po	W	t1
ABS	5.31±0.10	6.68±0.10	1.59±0.10	4.00±0.1	12.0±0.10	0.30±0.02

- 13 "antistatic plastic reel

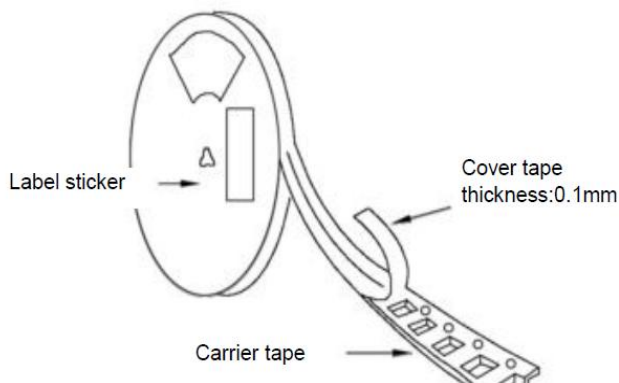

DEVICE TYPE	13" Reel			
	Q'TY/REEL(pcs)	REEL/BOX	BOX/CARTOON	Q'TY/CARTON(pcs)
ABS	5000	2	8	80000



# Surface mounted rectifier bridge reactor

ABS01 THRU ABS10

VOLTAGE RANGE	100 to 1000 Volts
CURRENT	1.0 Ampere

## Marking Code

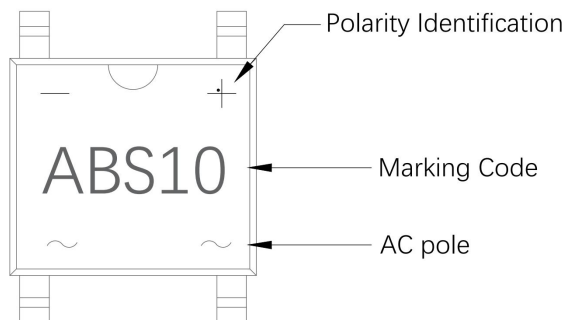

## Part Number Code

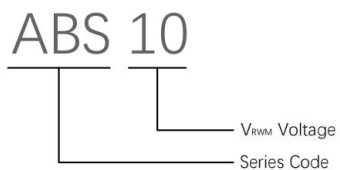



Reflow Profile

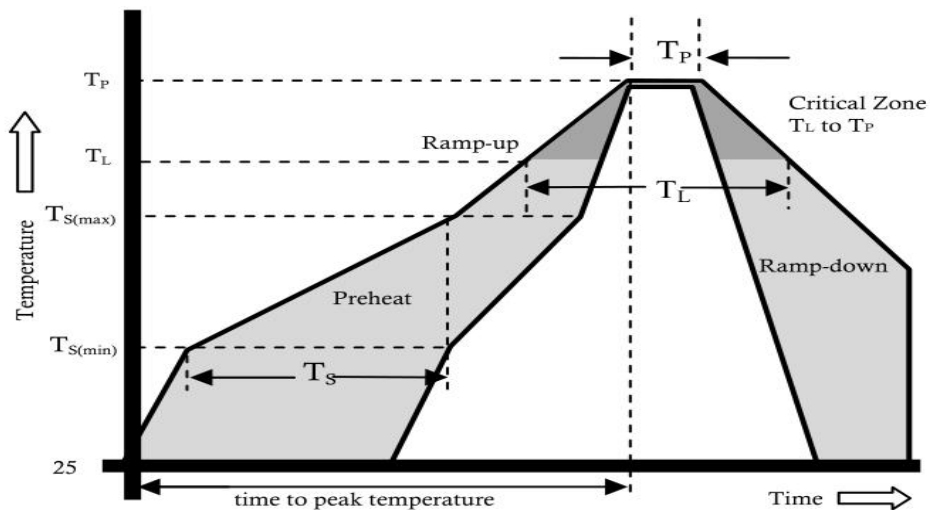

Reflow Condition		Pb-Free Assembly
Pre Heat	Temperature Min.	+150°C
	Temperature Max.	+200°C
	Time(Min to Max)	60-180 secs.
Average ramp up rate(Liquidus Temp( $T_L$ ) to peak)		3°C/sec. Max.
$T_S$ (max) to $T_L$ - Ramp-up Rate		3°C/sec. Max.
Reflow	Temperature ( $T_L$ )(Liquidus)	+217°C
	Temperature ( $T_I$ )	60-150 secs.
Peak Temp ( $T_P$ )		+(260+0/-5)°C
Time within 5°C of actual Peak Temp ( $T_P$ )		25 secs.
Ramp-down Rate		6°C/sec. Max.
Time 25°C to peak Temp ( $T_P$ )		8 min. Max.
Do not exceed		+260°C



---

ABS01 THRU ABS10

VOLTAGE RANGE

100 to 1000 Volts

CURRENT

1.0 Ampere

---

### Disclaimer

The information presented in this document is for reference only. Chongqing changjie Electronic Technology Co., Ltd. reserves the right to make changes without notice for the specification of the products displayed herein to improve reliability, function or design or otherwise.

The product listed herein is designed to be used with ordinary electronic equipment or devices, and not designed to be used with equipment or devices which require high level of reliability and the malfunction of which would directly endanger human life (such as medical instruments, transportation equipment, aerospace machinery, nuclear-reactor controllers, fuel controllers and other safety devices), Changjie or anyone on its behalf, assumes no responsibility or liability for any damages resulting from such improper use of sale.

This publication supersedes & replaces all information previously supplied. For additional information, please visit our website [http:// www.czlangjie.com](http://www.czlangjie.com) , or consult your nearest Langjie's sales office for further assistance.