

### ● General Description

The AGM500P20D combines advanced trench MOSFET technology with a low resistance package to provide extremely low  $R_{DS(ON)}$

This device is ideal for load switch and battery protection applications.

### ● Features

- Advance high cell density Trench technology
- Low  $R_{DS(ON)}$  to minimize conductive loss
- Low Gate Charge for fast switching
- Low Thermal resistance
- 100% Avalanche tested
- 100% DVDS tested

### ● Application

- MB/VGA Vcore
- SMPS 2<sup>nd</sup> Synchronous Rectifier
- POL application
- BLDC Motor driver

### Product Summary

BVDSS	RDS(ON)	ID
-200V	500mΩ	-12A

### TO-252 Pin Configuration

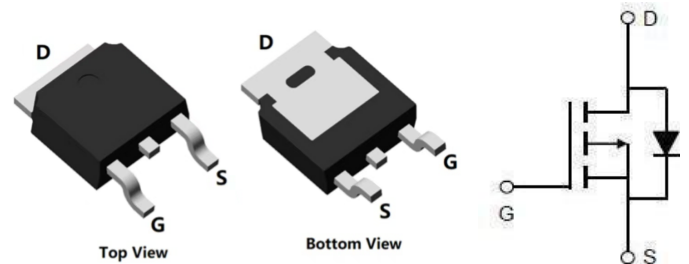

### Package Marking and Ordering Information

Device Marking	Device	Device Package	Reel Size	Tape width	Quantity
AGM500P20D	AGM500P20D	TO-252	330mm	16mm	2500

Table 1. Absolute Maximum Ratings (TA=25°C)

Symbol	Parameter	Value	Unit
VDS	Drain-Source Voltage (VGS=0V)	-200	V
VGS	Gate-Source Voltage (VDS=0V)	±20	V
ID	Drain Current-Continuous(Tc=25°C) (Note 1)	-12	A
	Drain Current-Continuous(Tc=100°C)	-7.0	A
IDM (pluse)	Drain Current-Continuous@ Current-Pulsed (Note 2)	-48	A
PD	Maximum Power Dissipation(Tc=25°C)	35	w
	Maximum Power Dissipation(Tc=100°C)	13.9	w
EAS	Avalanche energy (Note 3)	--	mJ
TJ,TSTG	Operating Junction and Storage Temperature Range	-55 To 150	°C

Table 2. Thermal Characteristic

Symbol	Parameter	Typ	Max	Unit
RθJA	Thermal Resistance Junction-ambient (Steady State) <sup>1</sup>	---	50	°C/W
RθJC	Thermal Resistance Junction-Case <sup>1</sup>	---	3.6	°C/W

**Table 3. Electrical Characteristics (TC=25°C unless otherwise noted)**

Symbol	Parameter	Conditions	Min	Typ	Max	Unit
<b>On/Off States</b>						
BVDSS	Drain-Source Breakdown Voltage	VGS=0V ID=-250μA	-200	--	--	V
IDSS	Zero Gate Voltage Drain Current	VDS=-200V,VGS=0V	--	--	-1	μA
IGSS	Gate-Body Leakage Current	VGS=±20V,VDS=0V	--	--	±100	nA
VGS(th)	Gate Threshold Voltage	VDS=VGS,ID=-250μA	-2.0	--	-4.0	V
gFS	Forward Transconductance	VDS=5V,ID=-3A	--	15	--	S
RDS(on)	Drain-Source On-State Resistance	VGS=-10V, ID=-5A	--	500	650	mΩ
<b>Dynamic Characteristics</b>						
Ciss	Input Capacitance	VDS=-160V, VGS=0V, F=1MHZ	--	1210	--	pF
Coss	Output Capacitance		--	170	--	pF
Crss	Reverse Transfer Capacitance		--	45	--	pF
Rg	Gate resistance	f=1.0MHz	--	--	--	Ω
<b>Switching Times</b>						
td(on)	Turn-on Delay Time	VGS=-10V,VDS=-160V, RGEN=10Ω,ID=-5A	--	13.5	--	nS
tr	Turn-on Rise Time		--	16	--	nS
td(off)	Turn-Off Delay Time		--	52	--	nS
tf	Turn-Off Fall Time		--	25	--	nS
Qg	Total Gate Charge	VGS=-10V, VDS=-160V, ID=-5A	--	35	--	nC
Qgs	Gate-Source Charge		--	6	--	nC
Qgd	Gate-Drain Charge		--	15	--	nC
<b>Source-Drain Diode Characteristics</b>						
ISD	Source-Drain Current(Body Diode)		--	--	-12	A
VSD	Forward on Voltage	VGS=0V,IS=-5A	--	--	-1.3	V
trr	Reverse Recovery Time	Isd=-5A , dl/dt=100A/μs , TJ=25°C	--	17	--	ns
Qrr	Reverse Recovery Charge		--	13	--	nc

Notes 1.The maximum current rating is package limited.

Notes 2.Repetitive Rating: Pulse width limited by maximum junction temperature

Notes 3.EAS condition: TJ=25°C

### 7. Typical Characteristics (Cont.)

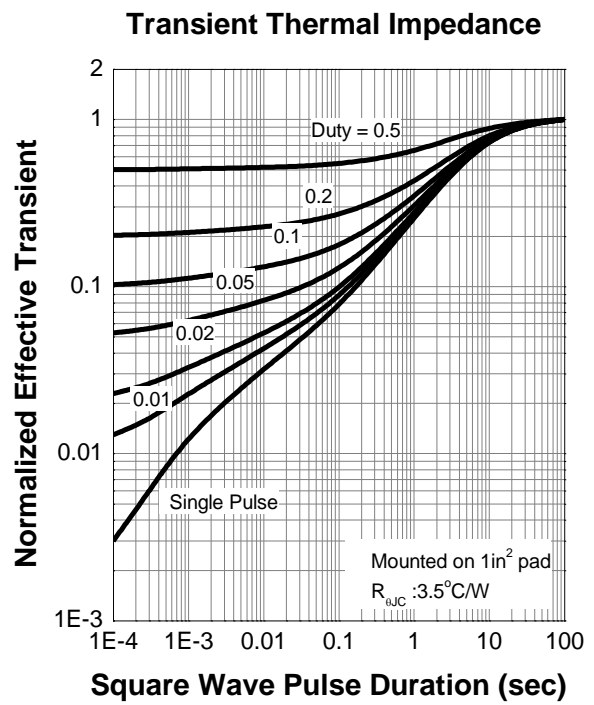
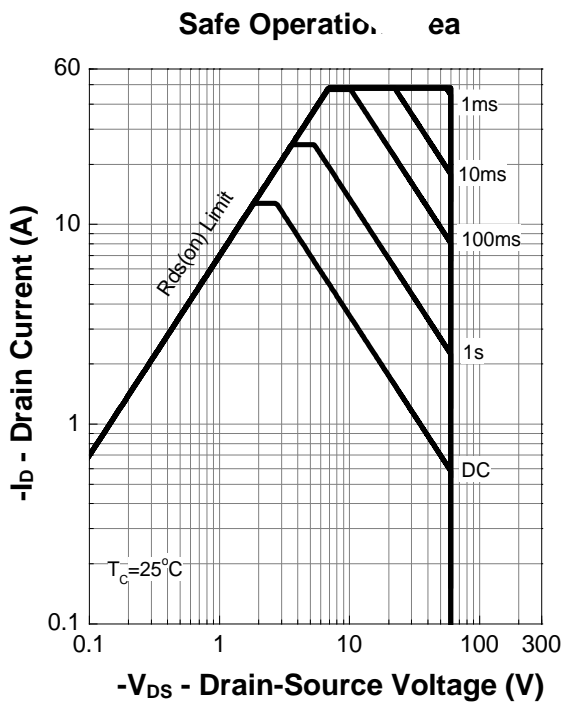
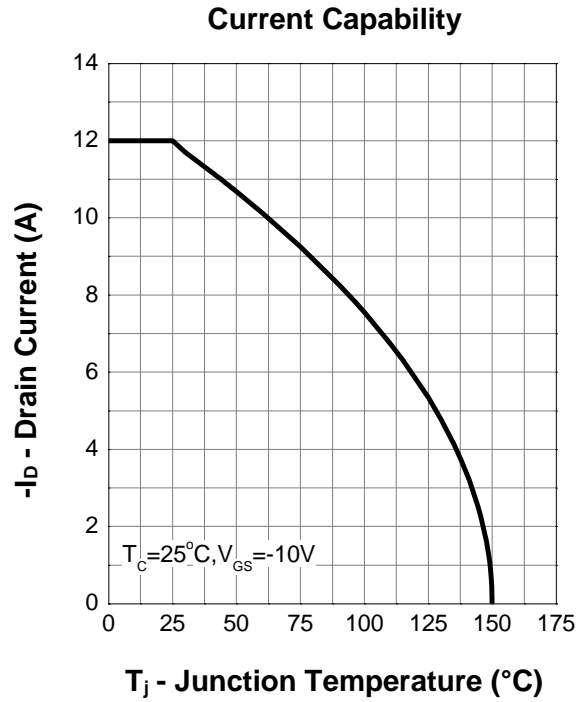
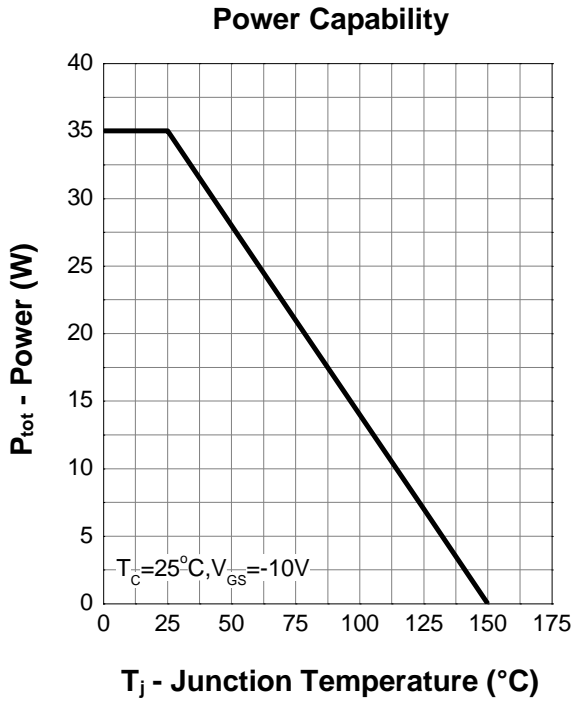

## 7. Typical Characteristics (Cont.)

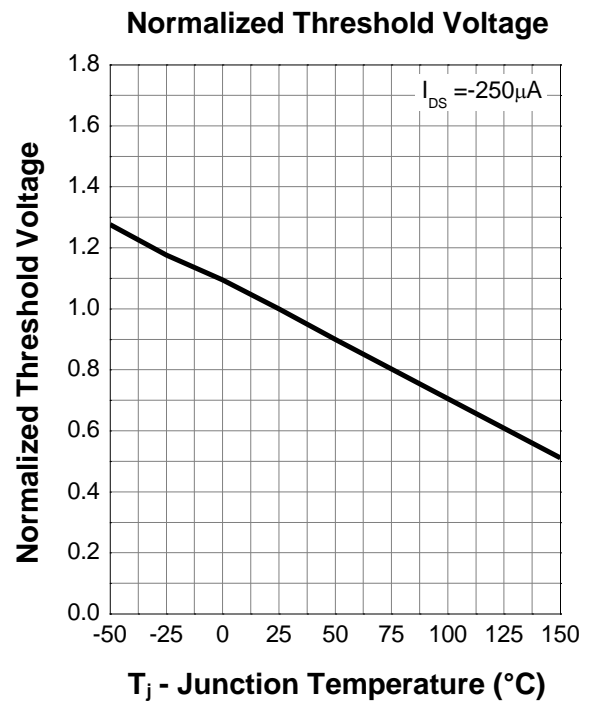
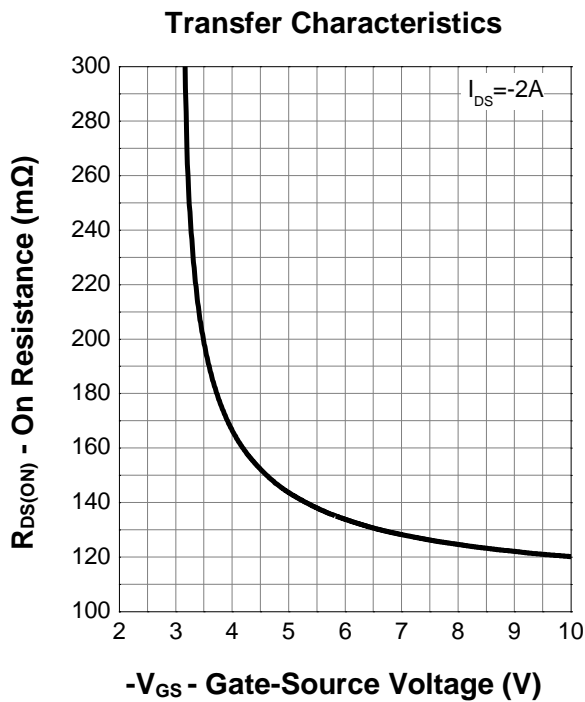
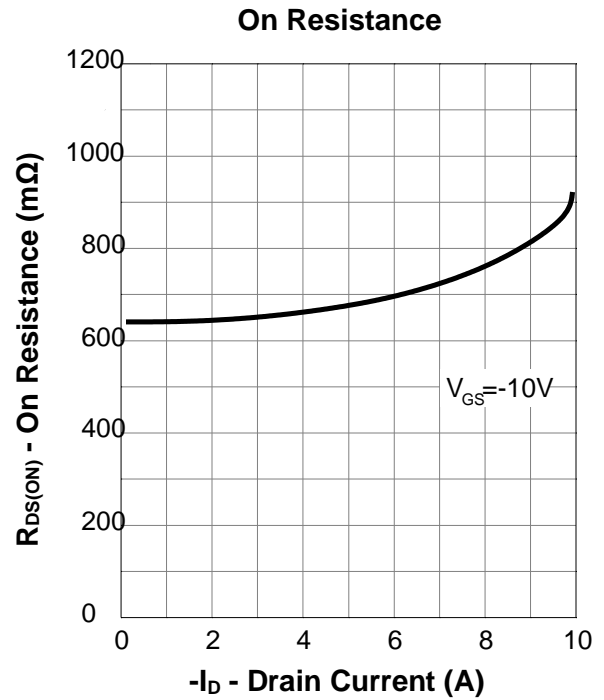
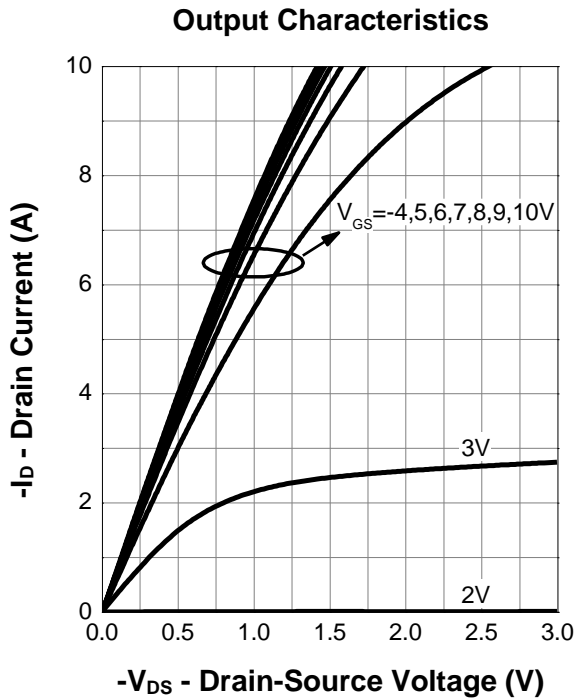

## 7. Typical Characteristics (cont.)

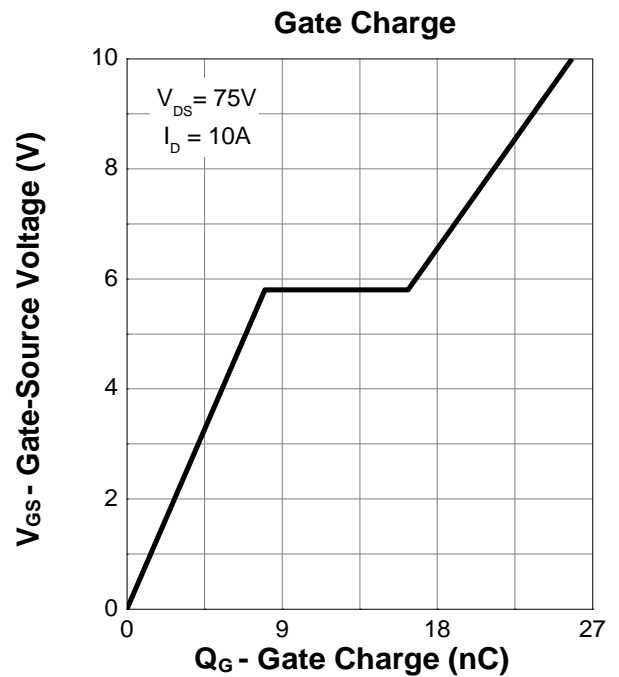
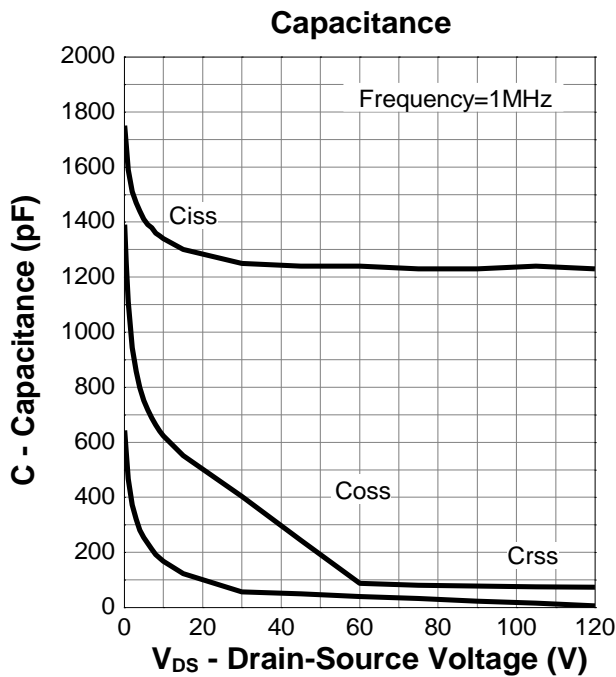
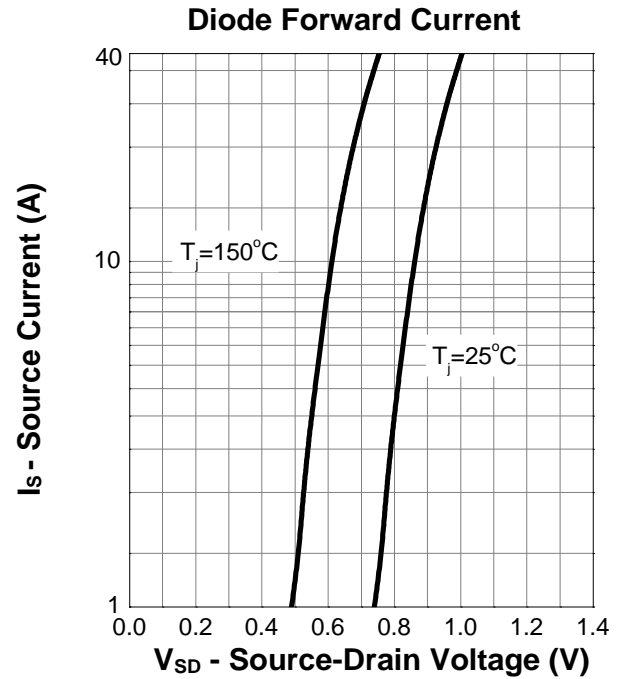
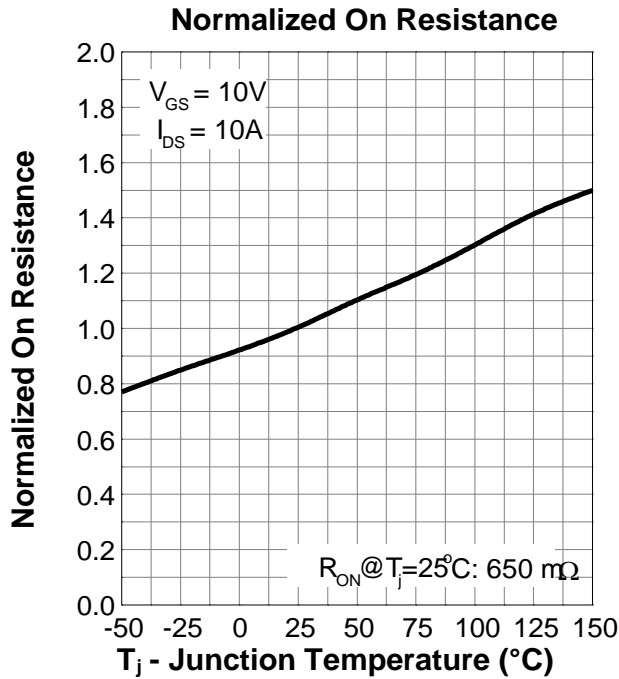

## TO-252 Package Outline Data

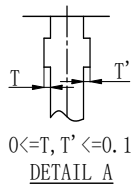
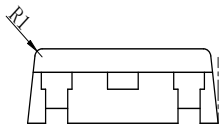
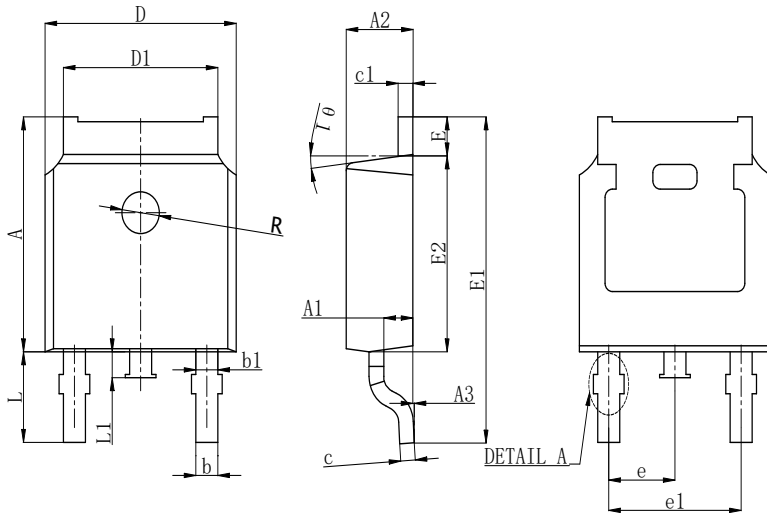
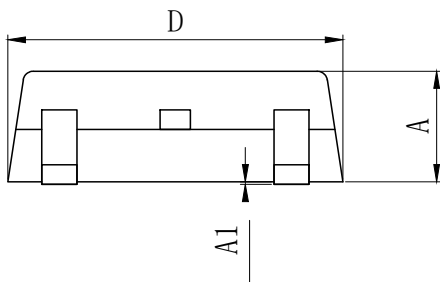
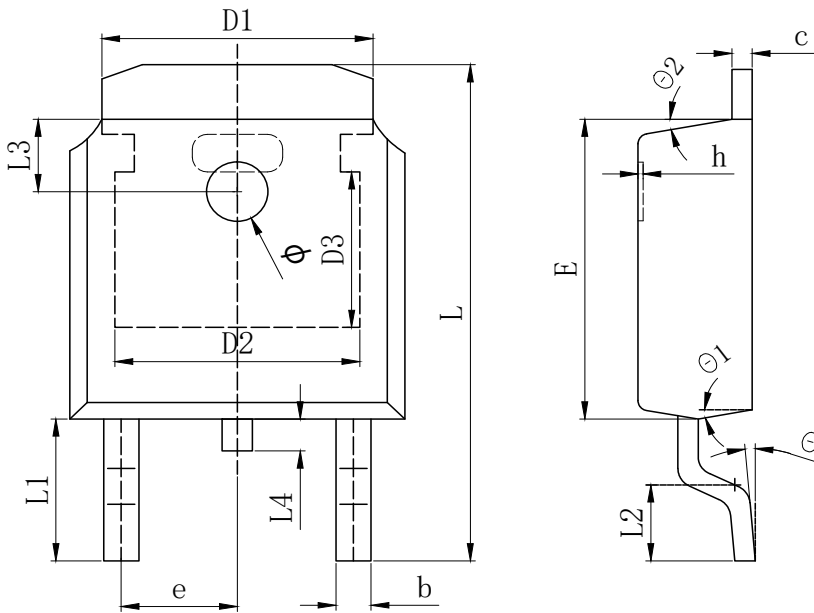

SYMBOL	MILLIMETER		
	MIN	Typ.	MAX
A	2.200	2.300	2.400
A1	0.000		0.127
b	0.640	0.690	0.740
c (电镀后)	0.460	0.520	0.580
D	6.500	6.600	6.700
D1	5.334 REF		
D2	4.826 REF		
D3	3.166 REF		
E	6.000	6.100	6.200
e	2.286 TYP		
h	0.000	0.100	0.200
L	9.900	10.100	10.300
L1	2.888 REF		
L2	1.400	1.550	1.700
L3	1.600 REF		
L4	0.600	0.800	1.000
φ	1.100	1.200	1.300
θ	0°		8°
θ 1	9° TYP		
θ 2	9° TYP		

SYMBOL	MILLIMETER		
	MIN	NOM	MAX
A	7.050	7.100	7.150
A1	0.960	1.010	1.060
A2	2.250	2.300	2.350
A3	0.000	0.050	0.100
b	0.760REF.		
b1	1.000REF.		
c	0.508REF.		
c1	0.508REF.		
D	6.550	6.600	6.650
D1	5.220	5.320	5.420
E	0.950	1.000	1.050
E1	9.700	9.900	10.100
E2	6.050	6.100	6.150
e	2.286BSC		
e1	4.572REF.		
L	2.650	2.800	2.950
L1	0.700	0.800	0.900
θ 1	7° REF.		
R	1.300REF.		
R1	0.250REF.		

Disclaimer:

The information provided in this document is believed to be accurate and reliable. however, Shenzhen Core Control Electronics Technology Co., Ltd. does not assume any responsibility for the following consequences. Do not consider the use of such information or use beyond its scope.

The information mentioned in this document may be changed at any time without notice.

The products and information provided in this document do not infringe patents. Shenzhen Core Control Electronics Technology Co., Ltd. assumes no responsibility for any infringement of any other rights of third parties. The result of using such products and information.

This document is the first version issued on July 10th, 2023. This document replaces all previously provided information.

 It is a registered trademark of Shenzhen Core Control Electronics Technology Co., Ltd.

Copyright © 2017 Shenzhen Core Control Electronics Technology Co., Ltd. all rights reserved.