

Infrared Receiver Module IRM-56384(BY) Datasheet

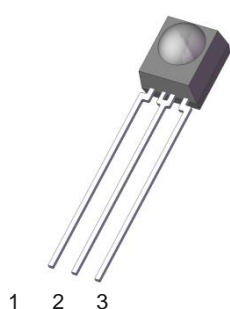

Pin Configuration

1. Vout
2. GND
3. Vcc

Block Diagram

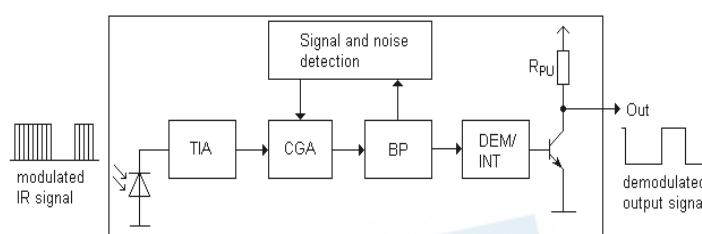

Features

- High protection ability against EMI
- Circular lens to improve the receive characteristic
- Low voltage
- High immunity against ambient light
- Photodiode with integrated circuit
- TTL and CMOS compatibility
- Long reception distance
- High sensitivity
- Pb free and RoHS compliant
- Compliance with EU REACH

Description

The IRM-56384(BY) device is miniature type infrared remote control system receiver which has been developed and designed by utilizing the most updated IC technology.

The PIN diode and preamplifier are assembled on lead frame, the epoxy package is designed as an IR filter.

The demodulated output signal can directly be decoded by a microprocessor.

Applications

- AV equipment such as TV, VCR, DVD, CD, MD, etc.
- Toy applications
- CATV set top boxes
- Multi-media Equipment

Application Circuit

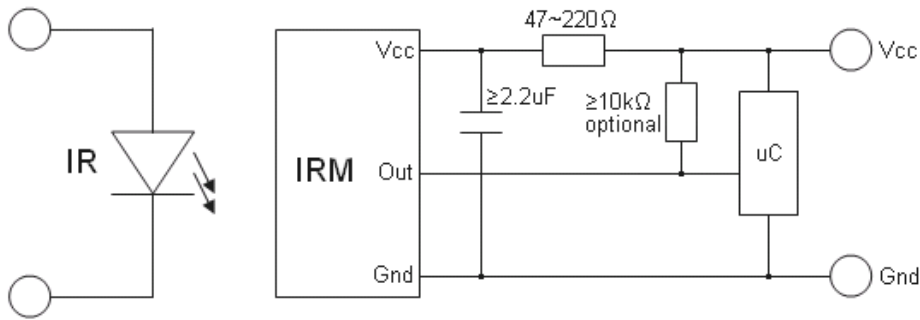

RC Filter should be connected closely between Vcc pin and GND pin.

Parts Number Table

Model No.	Carrier Frequency
IRM-56384(BY)	38 kHz

Absolute Maximum Ratings (Ta=25°C) *1

Parameter	Symbol	Rating	Unit
Supply Voltage	Vcc	6	V
Operating Temperature	Topr	-20 ~ +80	°C
Storage Temperature	Tstg	-40 ~ +85	°C
Soldering Temperature *2	Tsol	260	°C

*1 Stresses in excess of the absolute maximum ratings can cause permanent damage to the device. Functional operation of the device is not implied at these or any other conditions in excess of those given in the operational sections of this document. Exposure to absolute maximum ratings for extended periods of the time can adversely affect reliability

*2 4mm from mold body for less than 5 seconds

Electro-Optical Characteristics (Ta=25°C and Vcc=3.0V)

Parameter	Symbol	Min.	Typ.	Max	Unit	Condition
Current consumption	Icc	---	---	2.0	mA	No input signal
Supply voltage	Vcc	2.7	---	5.5	V	
Peak wavelength	λ_p	---	940	---	nm	
Reception range	L ₀	14	---	---	m	See chapter 'Test method' *3
	L ₄₅	6	---	---		
Half angle(horizontal)	φ_h	---	±35	---	deg	
Half angle(vertical)	φ_v	---	±35	---	deg	
High level pulse width	T _H	400	---	800	μs	Test signal according to figure 1 *4
Low level pulse width	T _L	400	---	800	μs	
High level output voltage	V _{OH}	Vcc-0.4	---	---	V	
Low level output voltage	V _{OL}	---	0.2	0.5	V	

*3 The ray receiving surface at a vertex and relation to the ray axis in the range of $\theta=0^\circ$ and $\theta=45^\circ$.

*4 A range from 30cm to the arrival distance. Average value of 50 pulses.

Test method

The specified electro-optical characteristics are valid under the following conditions.

1. Measurement environment

A place without extreme light reflections.

2. External light

The environment contains an ordinary, white fluorescent lamp without high frequency modulation. The color temperature is 2856K and the illumination at the IR receiver is less than 10 Lux ($E_v \leq 10\text{Lux}$).

3. Standard transmitter

The test transmitter is calibrated by using the circuit shown in Figure 2. The radiation intensity of the transmitter is adjusted until $V_o=400\text{mVp-p}$. Both the test transmitter and the photo diode have the peak wavelength of 940nm. The photo diode for calibration is PD438B ($\lambda_p=940\text{nm}$, $V_r=5\text{V}$).

4. The measurement system is shown in Fig.-3

Fig.-1 Transmitter Wave Form

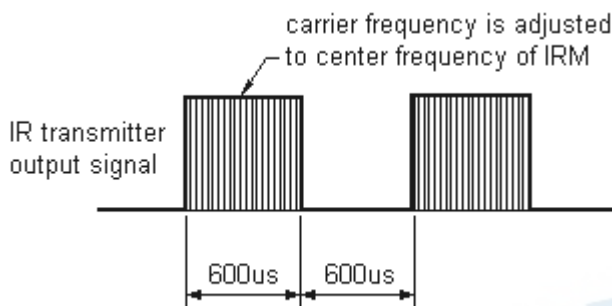

D.U.T output Pulse

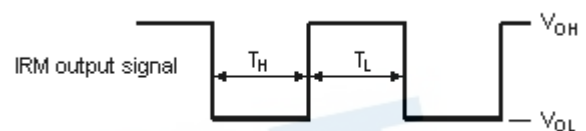

Fig.-2 Standard transmitter calibration

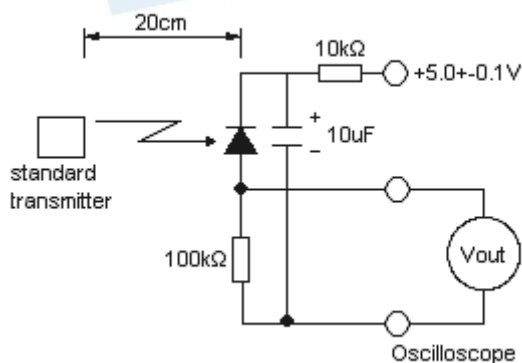
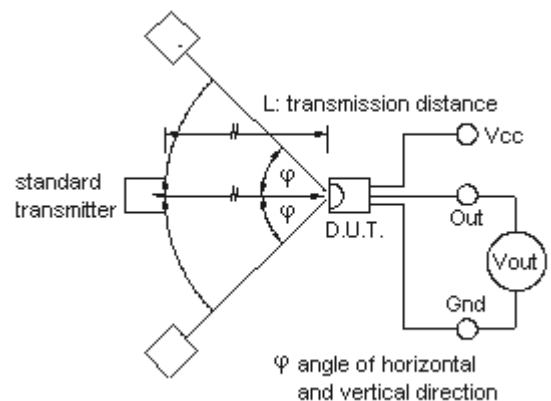

Fig.-3 Measuring System



Typical Electro-Optical Characteristics Curves

Fig.4 Relative Responsibility vs. Wavelength

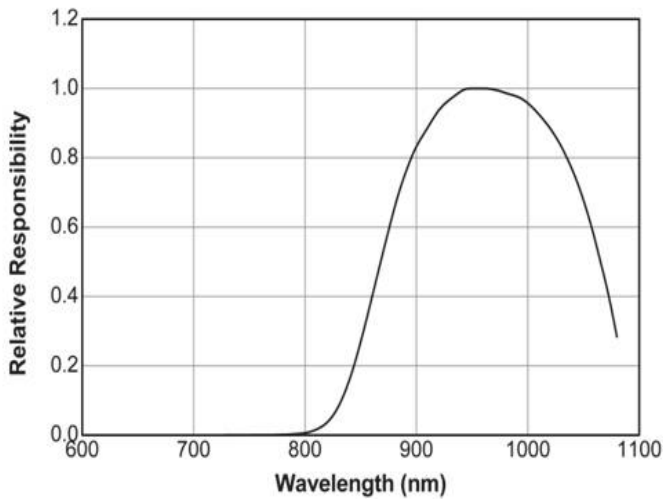

Fig.5 Relative Sensitivity vs. Angle

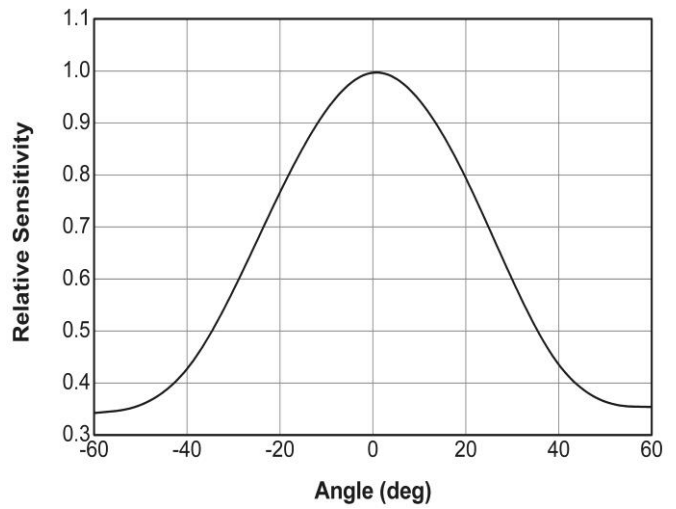

Fig.-6 Output Pulse Width TwL (usec) vs. Transmission Distance

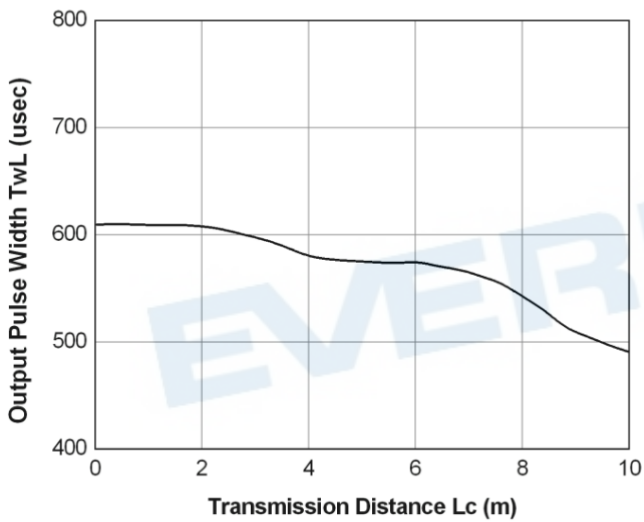

Fig.-7 Relative Sensitivity vs. Supply Voltage

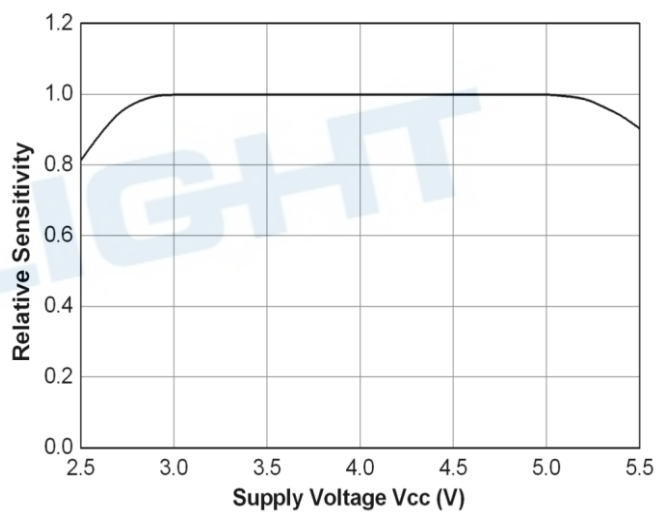
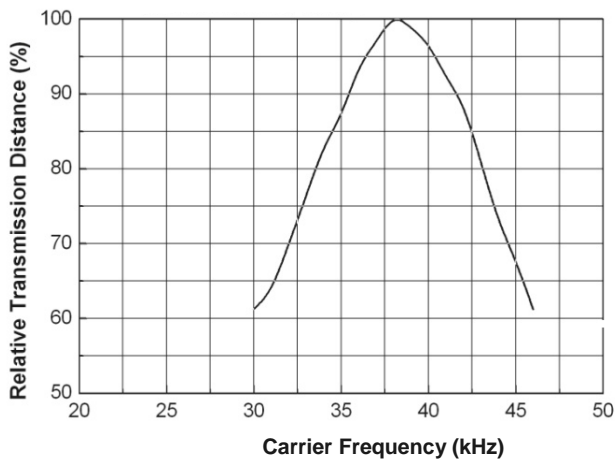
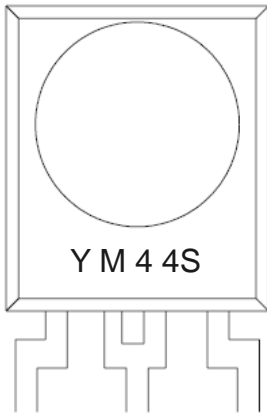

Fig.8 Relative Transmission Distance vs. Carrier Frequency



Device Marking



Note:

- Y denotes date code
- M denotes date code
- 4 denotes frequency
- 4S denotes model type

Packing Quantity

- 1500 pcs / Box
- 10 Boxes / Carton

EVERLIGHT

Package Dimensions
(Dimensions in mm)

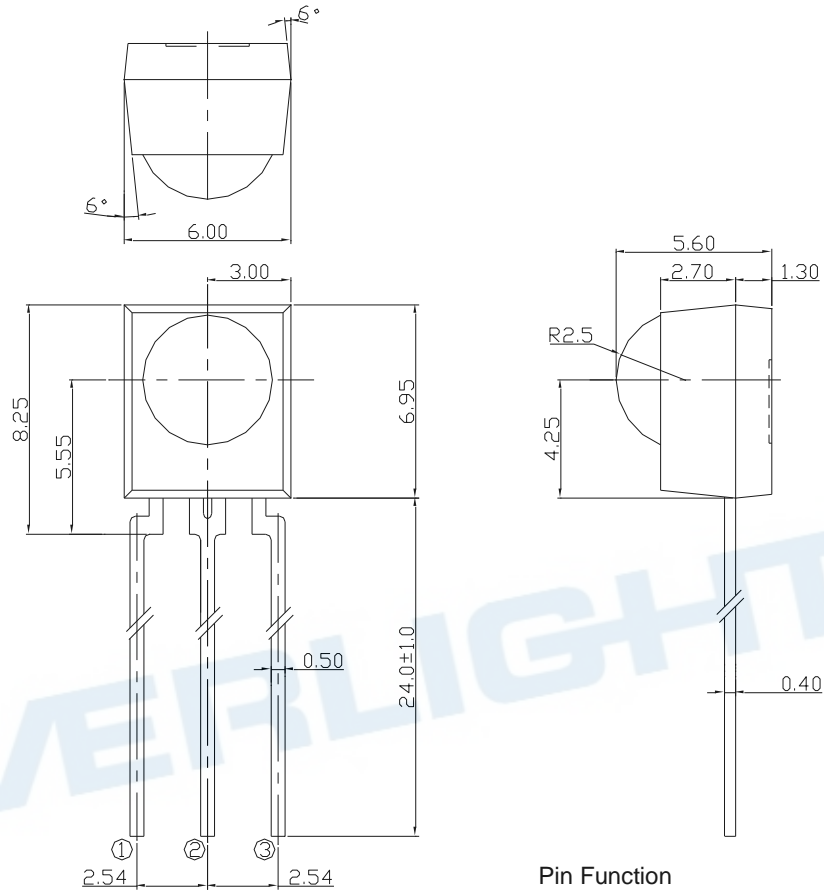

Pin Function

- ①: Vout
- ②: GND
- ③: Vcc

Notes:1. All dimensions are in millimeters.
2. Tolerances unless dimensions ± 0.5 mm.

Recommended method of storage

1. After shipment from Everlight, the LED should be stored at 10-30 °C and 60% RH or below, the storage period is 1 year, more than 1 year storage period, there will be stent yellowing
2. After opening the package, the LED must be stored in 10-25 °C and 20%-60% RH environment, it is recommended to use it as soon as possible within 24H, and the remaining LEDs need to be sealed in the bag as soon as possible
3. It is recommended to use flux when soldering LED, otherwise there will be a problem of eating less than 95% of the tin area.

DISCLAIMER

1. EVERLIGHT reserves the right(s) on the adjustment of product material mix for the specification.
2. The product meets EVERLIGHT published specification for a period of twelve (12) months from date of shipment.
3. The graphs shown in this datasheet are representing typical data only and do not show guaranteed values.
4. When using this product, please observe the absolute maximum ratings and the instructions for using outlined in these specification sheets. EVERLIGHT assumes no responsibility for any damage resulting from the use of the product which does not comply with the absolute maximum ratings and the instructions included in these specification sheets.
5. These specification sheets include materials protected under copyright of EVERLIGHT. Reproduction in any form is prohibited without obtaining EVERLIGHT's prior consent.
6. This product is not intended to be used for military, aircraft, automotive, medical, life sustaining or life saving applications or any other application which can result in human injury or death. Please contact authorized Everlight sales agent for special application request.