

4 PIN SSOP PHOTOTRANSISTOR PHOTOCOUPLER EL3H7-G Series

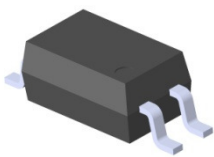

Schematic

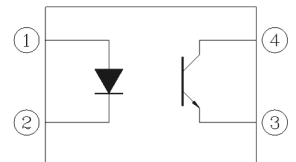

Features:

- Halogens free
(Br <900 ppm ,Cl <900 ppm , Br+Cl < 1500 ppm)
- Current transfer ratio
(CTR: 50~600% at IF =5mA, VCE =5V)
(CTR: 40~320% at IF =10mA, VCE =5V)
- High isolation voltage between input and output (Viso=3750 V rms)
- Compact 4 Pin SSOP with a 2.0 mm profile
- Compliance with EU REACH
- Pb free and RoHS compliant.
- UL and cUL approved(No. E214129)
- VDE approved (No. 132249)
- SEMKO approved
- NEMKO approved
- DEMKO approved
- FIMKO approved

Pin Configuration

1. Anode
2. Cathode
3. Emitter
4. Collector

Description

The EL3H7-G series devices consist of an infrared emitting diode, optically coupled to a phototransistor detector encapsulated with green compound.

They are packaged in a 4-pin small outline SMD package.

Applications

- DC-DC Converters
- Programmable controllers
- Telecommunication equipments
- Signal transmission between circuits of different potentials and impedances

Absolute Maximum Ratings (Ta=25°C)

| | Parameter | Symbol | Rating | Unit |
|-------------------------|--|------------|------------|-------------|
| Input | Forward current | I_F | 50 | mA |
| | Peak forward current (1us, pulse) | I_{FP} | 1 | A |
| | Reverse voltage | V_R | 6 | V |
| | Power dissipation Derating factor (above $T_a = 90^\circ\text{C}$) | P_D | 70 2.0 | mW mW/°C |
| Output | Power dissipation Derating factor (above $T_a = 70^\circ\text{C}$) | P_C | 150 3.1 | mW mW/°C |
| | Collector current | I_C | 50 | mA |
| | Collector-Emitter voltage | V_{CEO} | 80 | V |
| | Emitter-Collector voltage | V_{ECO} | 7 | V |
| | Total Power Dissipation | P_{TOT} | 200 | mW |
| Isolation Voltage*1 | V_{ISO} | 3750 | Vrms | |
| Operating temperature | T_{OPR} | -55 ~ +110 | °C | |
| Storage temperature | T_{STG} | -55 ~ +125 | °C | |
| Soldering Temperature*2 | T_{SOL} | 260 | °C | |

Notes:

*1 AC for 1 minute, R.H.= 40 ~ 60% R.H. In this test, pins 1, 2 are shorted together, and pins 3, 4 are shorted together.

*2 For 10 seconds

Electro-Optical Characteristics (Ta=25°C unless specified otherwise)

Input

| Parameter | Symbol | Min. | Typ. | Max. | Unit | Condition |
|-------------------|----------|------|------|------|---------------|--------------------------|
| Forward voltage | V_F | - | 1.2 | 1.4 | V | $I_F = 20\text{mA}$ |
| Reverse current | I_R | - | - | 10 | μA | $V_R = 4\text{V}$ |
| Input capacitance | C_{in} | - | 30 | 250 | pF | $V = 0, f = 1\text{kHz}$ |

Output

| Parameter | Symbol | Min | Typ. | Max. | Unit | Condition |
|-------------------------------------|------------|-----|------|------|------|---|
| Collector-Emitter dark current | I_{CEO} | - | - | 100 | nA | $V_{CE} = 20\text{V}, I_F = 0\text{mA}$ |
| Collector-Emitter breakdown voltage | BV_{CEO} | 80 | - | - | V | $I_C = 0.1\text{mA}$ |
| Emitter-Collector breakdown voltage | BV_{ECO} | 7 | - | - | V | $I_E = 0.1\text{mA}$ |

Transfer Characteristics (Ta=25°C unless specified otherwise)

| Parameter | Symbol | Min | Typ. | Max. | Unit | Condition | |
|--------------------------------------|---------------|--------------------|------|------|---------------|---|-----|
| Current Transfer ratio | EL3H7 | 50 | - | 600 | % | $I_F = 5\text{mA}, V_{CE} = 5\text{V}$ | |
| | EL3H7A | 80 | - | 160 | | | |
| | EL3H7B | 130 | - | 260 | | | |
| | EL3H7C | 200 | - | 400 | | | |
| | EL3H7D | 300 | - | 600 | | | |
| | EL3H7E | CTR | 100 | - | | | 200 |
| | EL3H7F | | 150 | - | | | 300 |
| | EL3H7H | | 40 | - | | | 80 |
| | EL3H7I | | 63 | - | | | 125 |
| | EL3H7J | | 100 | - | | | 200 |
| | EL3H7K | | 160 | - | | | 320 |
| Collector-Emitter saturation voltage | $V_{CE(sat)}$ | - | 0.1 | 0.2 | V | $I_F = 10\text{mA}, I_C = 1\text{mA}$ | |
| Isolation resistance | R_{IO} | 5×10^{10} | - | - | Ω | $V_{IO} = 500\text{Vdc}, 40\sim 60\% \text{ R.H.}$ | |
| Floating capacitance | C_{IO} | - | 0.3 | 1.0 | pF | $V_{IO} = 0, f = 1\text{MHz}$ | |
| Rise time | t_r | - | 5 | 18 | μs | $V_{CE} = 2\text{V}, I_C = 2\text{mA}, R_L = 100\Omega$ | |
| Fall time | t_f | - | 3 | 18 | μs | | |

* Typical values at $T_a = 25^\circ\text{C}$

Typical Electro-Optical Characteristics Curves

Figure 1. Forward Current vs Forward Voltage

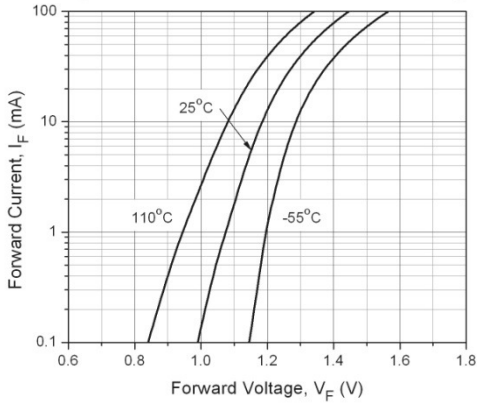

Figure 2. Normalized Collector Current vs Forward Current

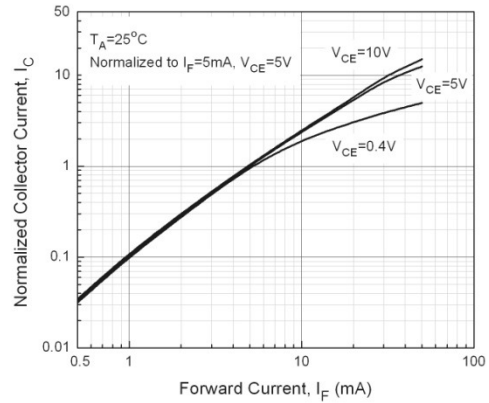

Figure 3. Normalized Current Transfer Ratio vs Forward Current

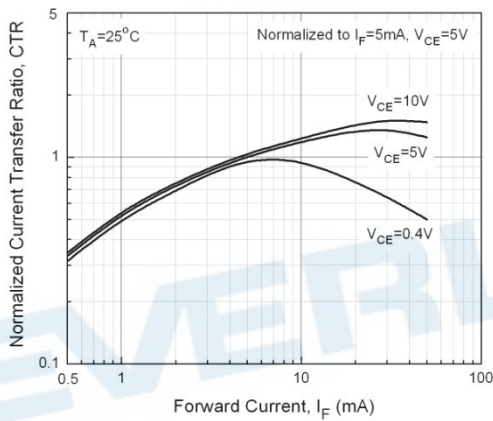

Figure 4. Normalized Collector Current vs Ambient Temperature

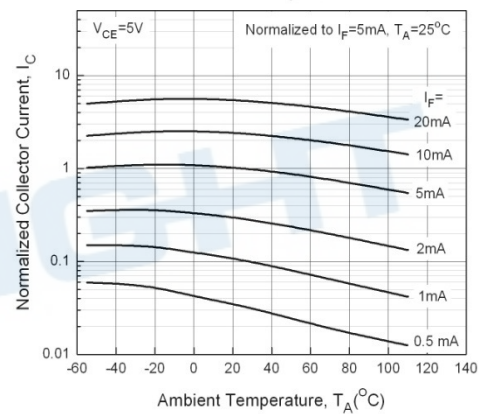

Figure 5. Normalized Current Transfer Ratio vs Ambient Temperature

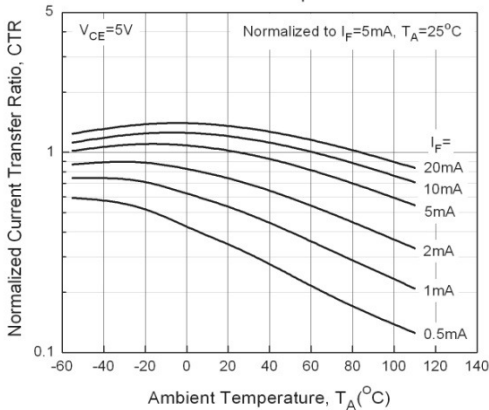

Figure 6. Collector Current vs Collector-Emitter Voltage

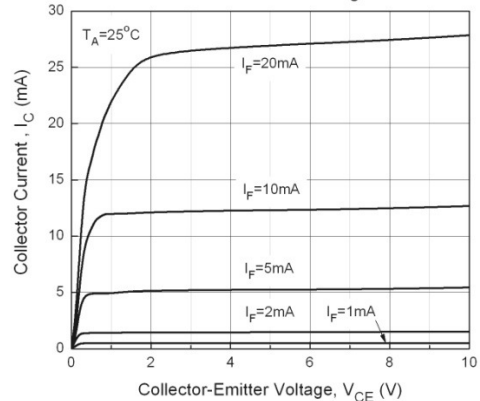

Figure 7. Collector Current vs Collector-Emitter Voltage

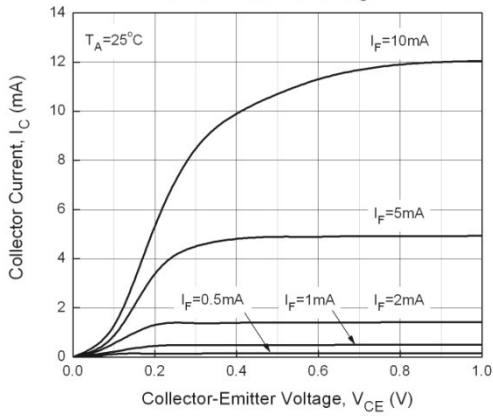

Figure 8. Collector Dark Current vs Ambient Temperature

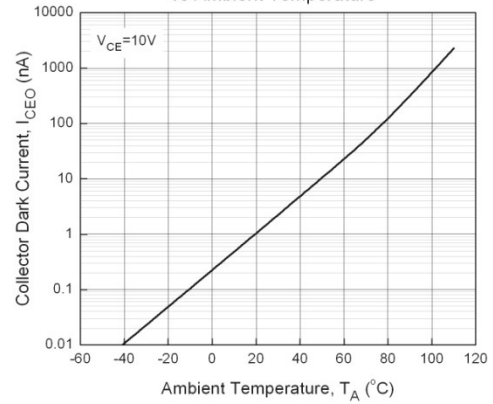

Figure 9. Collector-Emitter Saturation Voltage vs Ambient Temperature

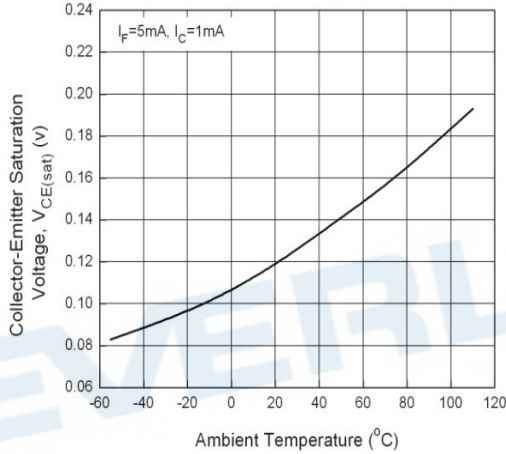

Figure 10. Switching Time vs Load Resistance

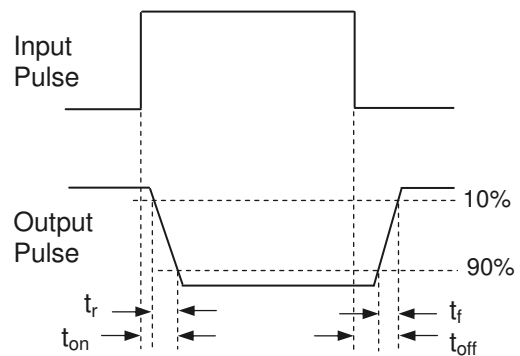
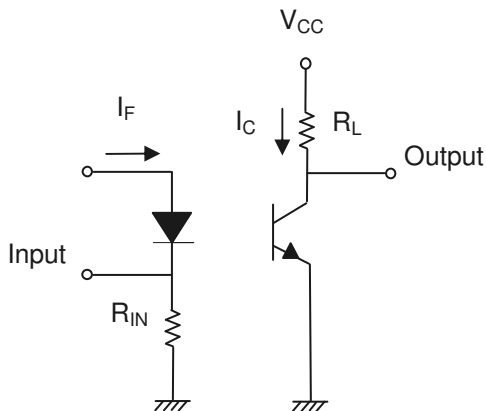
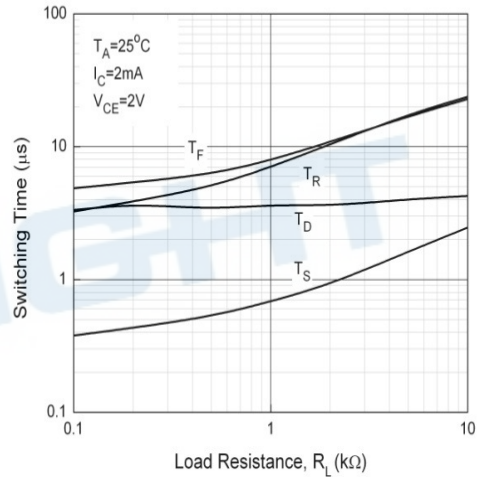

Figure 11. Switching Time Test Circuit & Waveforms

Order Information

Part Number

EL3H7(X)(Y)-VG

Note

- X = CTR Rank (A, B, C, D, E, F, H, I, J, K or none)
- Y = Tape and reel option (TA, TB, EA, EB or none)
- V = VDE (optional)
- G = Halogens free

| Option | Description | Packing quantity |
|--------|-----------------------------|---------------------|
| None | Standard SMD option | 150 units per tube |
| -V | Standard SMD option + VDE | 150 units per tube |
| (TA) | TA Tape & reel option | 5000 units per reel |
| (TB) | TB Tape & reel option | 5000 units per reel |
| (TA)-V | TA Tape & reel option + VDE | 5000 units per reel |
| (TB)-V | TB Tape & reel option + VDE | 5000 units per reel |
| (EA) | TA Tape & reel option | 1000 units per reel |
| (EB) | TB Tape & reel option | 1000 units per reel |
| (EA)-V | TA Tape & reel option + VDE | 1000 units per reel |
| (EB)-V | TB Tape & reel option + VDE | 1000 units per reel |

Package Dimension (Dimensions in mm)

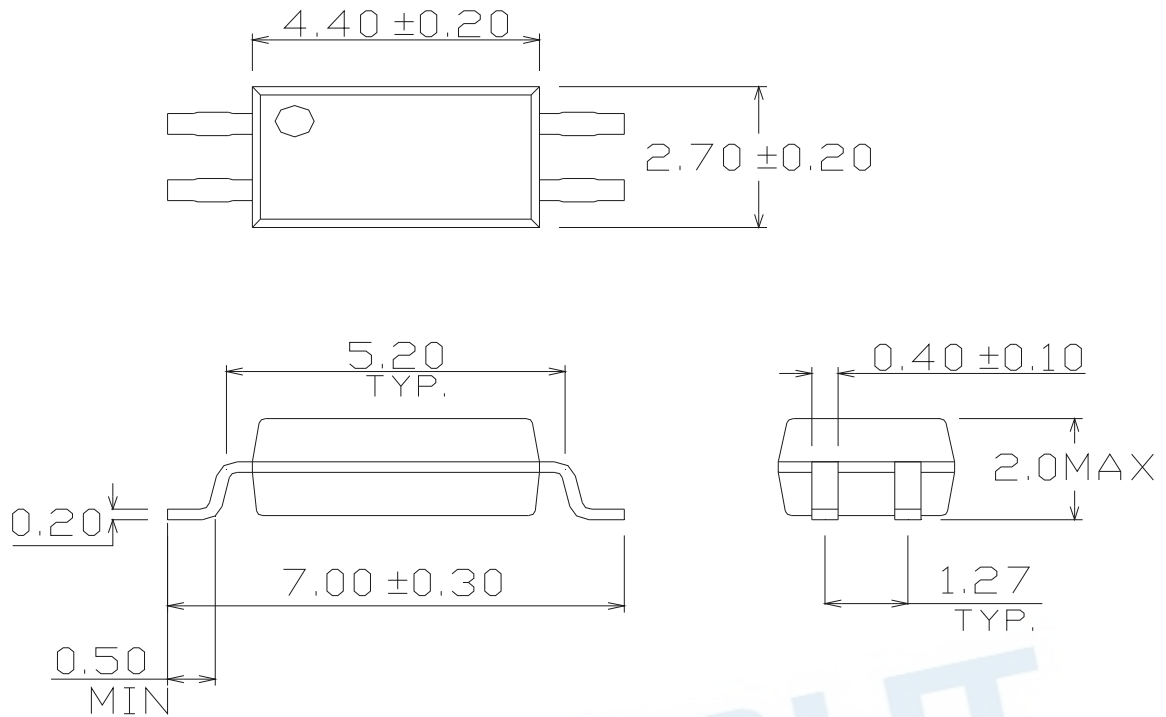

Recommended pad layout for surface mount leadform

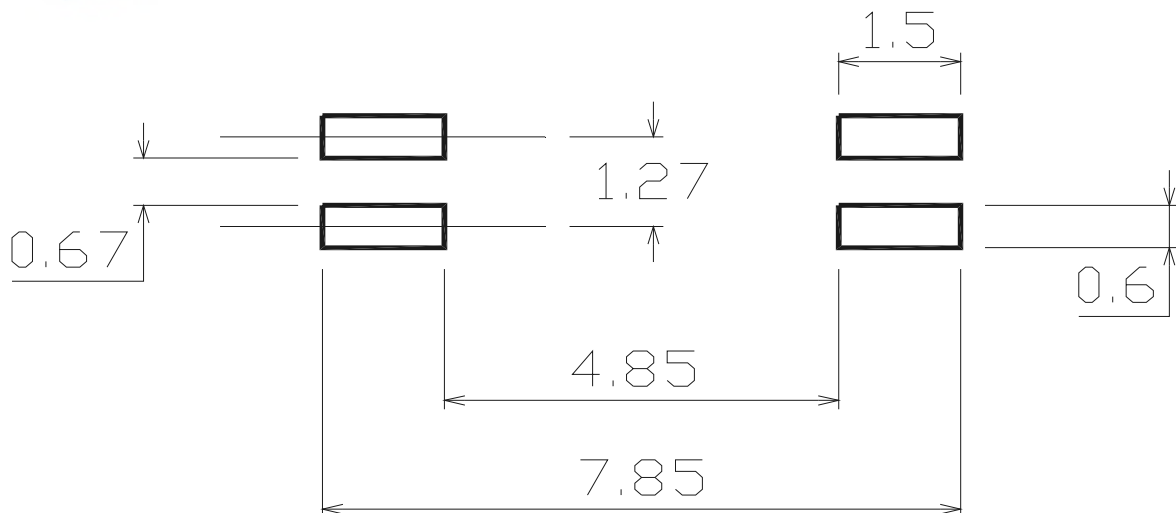

Device Marking



Notes

| | |
|-----|---|
| EL | denotes Everlight |
| 3H7 | denotes Device Number |
| R | denotes CTR Rank (A, B, C, D, E, F, H, I, J, K or none) |
| Y | denotes 1 digit Year code |
| WW | denotes 2 digit Week code |
| V | denotes VDE (optional) |

EVERLIGHT

Tape & Reel Packing Specifications

Option TA

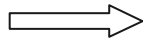
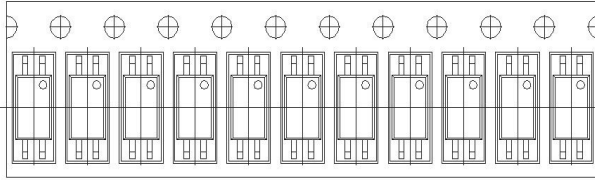

Direction of feed from reel

Option TB

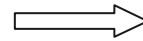
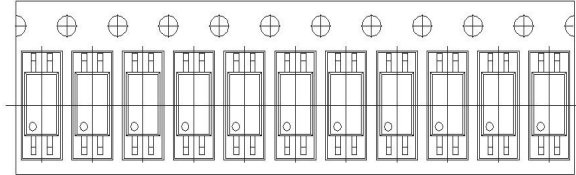

Direction of feed from reel

Tape dimensions

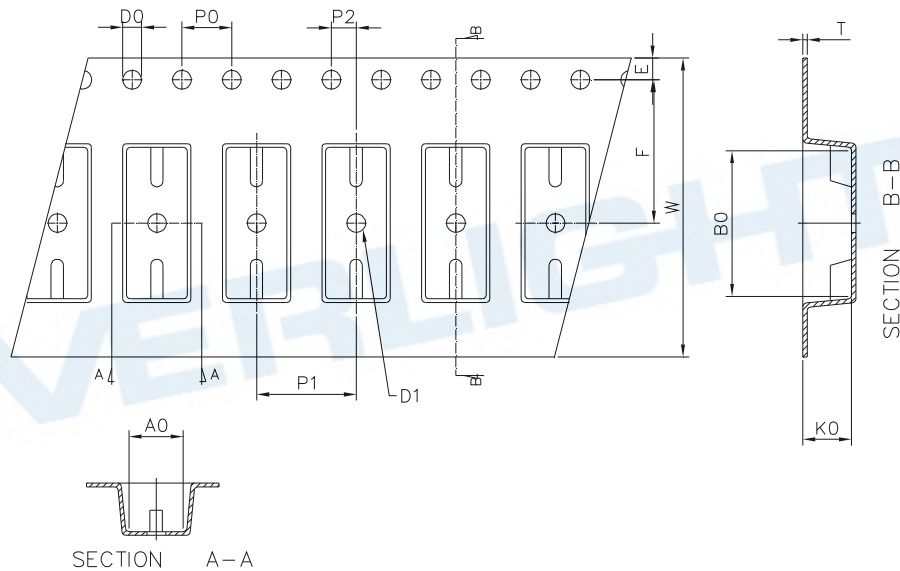

| | | | | | | |
|----------------|-------------|-------------|---------------|-------------|-------------|-------------|
| Dimension No. | A0 | B0 | D0 | D1 | E | F |
| Dimension (mm) | 3.00 ± 0.10 | 7.45 ± 0.10 | 1.50 + 0.1/-0 | 1.50 ± 0.10 | 1.75 ± 0.10 | 5.50 ± 0.10 |
| Dimension No. | P0 | P1 | P2 | t | W | K0 |
| Dimension (mm) | 4.00 ± 0.15 | 4.00 ± 0.10 | 2.00 ± 0.10 | 0.30 ± 0.05 | 12.1 ± 0.2 | 2.45 ± 0.1 |

Precautions for Use

1. Soldering Condition

1.1 (A) Maximum Body Case Temperature Profile for evaluation of Reflow Profile

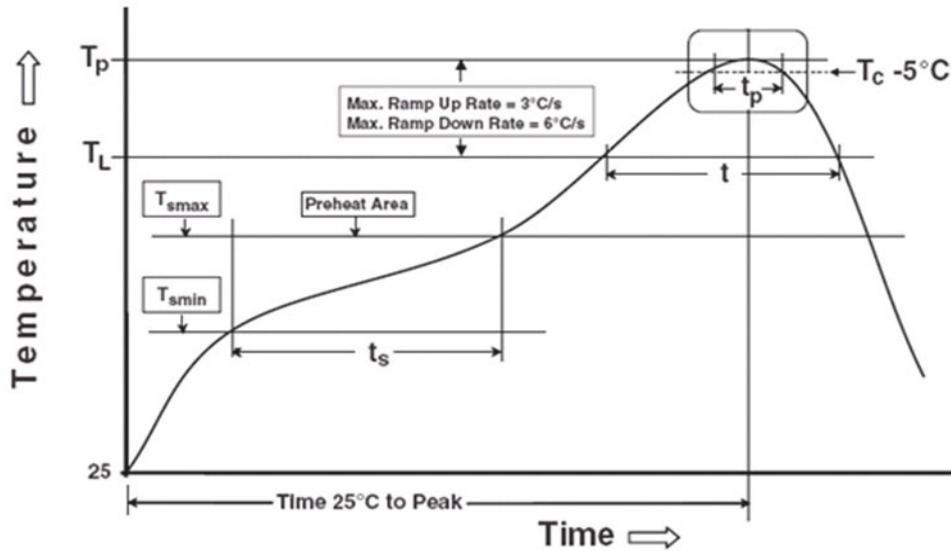

Note:

Reference: IPC/JEDEC J-STD-020D

Preheat

| | |
|--|-----------------|
| Temperature min (T_{smin}) | 150 °C |
| Temperature max (T_{smax}) | 200 °C |
| Time (T_{smin} to T_{smax}) (t_s) | 60-120 seconds |
| Average ramp-up rate (T_{smax} to T_p) | 3 °C/second max |

Other

| | |
|--|-------------------|
| Liquidus Temperature (T_L) | 217 °C |
| Time above Liquidus Temperature (t_L) | 60-100 sec |
| Peak Temperature (T_p) | 260 °C |
| Time within 5 °C of Actual Peak Temperature: $T_p - 5^\circ\text{C}$ | 30 s |
| Ramp- Down Rate from Peak Temperature | 6 °C /second max. |
| Time 25 °C to peak temperature | 8 minutes max. |
| Reflow times | 3 times |

DISCLAIMER

1. Above specification may be changed without notice. EVERLIGHT will reserve authority on material change for above specification.
2. When using this product, please observe the absolute maximum ratings and the instructions for using outlined in these specification sheets. EVERLIGHT assumes no responsibility for any damage resulting from use of the product which does not comply with the absolute maximum ratings and the instructions included in these specification sheets.
3. These specification sheets include materials protected under copyright of EVERLIGHT corporation. Please don't reproduce or cause anyone to reproduce them without EVERLIGHT's consent.

EVERLIGHT