



Features

- SOP package 8 Pin type in miniature design (4.4×9.37×2.1mm / .173×.37×.083inch)
- Low driver power requirements (TTL/CMOS Compatible)
- No moving parts
- High reliability
- Arc-Free with no snubbing circuits
- 1500Vrms Input/Output isolation
- Tape & Reel version available

Applications

- Telecommunications (PC, Electronic notepad)
- Measuring and Testing equipment
- Industrial control
- Security equipments
- High speed inspection machine

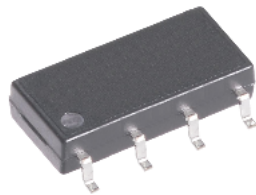

SOP-8

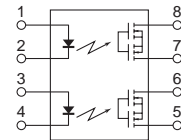

1,3. LED Anode
 2,4. LED Cathode
 5,6. Drain (MOS FET)
 7,8. Drain (MOS FET)

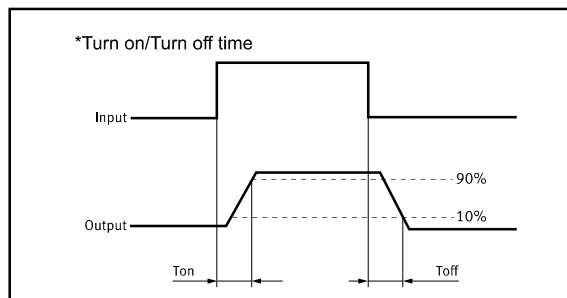

TYPES

Category	Output rating*1		Part No.	Packing quantity
	Load voltage	Load current		
AC/DC	400V	100mA	SOP-8 GAQW214S	Tape and reel 1-reel: 1,000 pcs.

Absolute Maximum Ratings (Ambient Temperature: 25°C)

Item		Symbol	Value	Units	Note
Input	Continuous LED Current	I_F	50	mA	
	Peak LED Current	I_{FP}	1000	mA	f=100Hz, duty=1%
	LED Reverse Voltage	V_R	5	V	
	Input Power Dissipation	P_{In}	75	mW	
Output	Load Voltage	V_L	400	V(AC peak or DC)	
	Load Current	I_L	100	mA	
	Peak Load Current	I_{Peak}	0.6	A	100ms(1 pulse)
	Output Power Dissipation	P_{out}	300	mW	
Total Power Dissipation		P_T	350	mW	
I/O Breakdown Voltage		$V_{I/O}$	1500	V _{rms}	RH=60%, 1min
Operating Temperature		T_{Opr}	-40 to +85	°C	
Storage Temperature		T_{Stg}	-40 to +100	°C	
Pin Soldering Temperature		T_{Sol}	260	°C	10 sec max.

Electrical Specifications (Ambient Temperature: 25°C)

Item		Symbol	MIN.	TYP.	MAX.	Units	Conditions
Input	LED Forward Voltage	V_F		1.2	1.4	V	$I_F=10mA$
	Operation LED Current	$I_{F On}$		0.5	1.0	mA	
	Recovery LED Current	$I_{F Off}$		0.35	0.5	mA	
	Recovery LED Voltage	$V_{F Off}$	0.7			V	
Output	On-Resistance	R_{On}		20	28	Ω	$I_F=5mA, I_L=100mA,$ Time to flow is within 1 sec.
	Off-State Leakage Current	I_{Leak}			1	uA	$V_L=Rating$
	Output Capacitance	C_{Out}		45		pF	$V_L=0, f=1MHz$
Transmis sion	Turn-On Time	T_{On}		0.23	0.5	ms	$I_F=5mA, I_L=100mA,$
	Turn-Off Time	T_{Off}		0.03	0.2	ms	
Coupled	I/O Isolation Resistance	$R_{I/O}$	10^{10}			Ω	DC500V
	I/O Capacitance	$C_{I/O}$		0.8	1.5	pF	f=1MHz

Reference Data

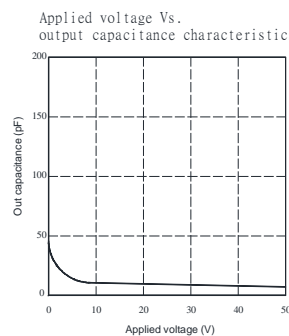
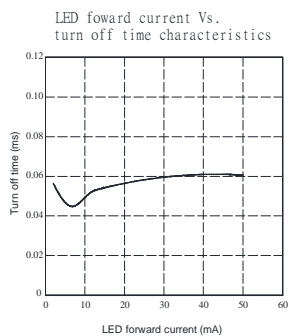
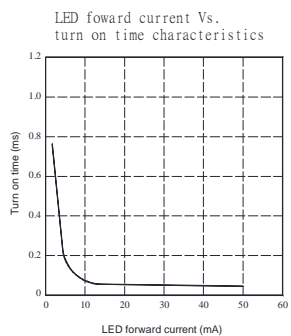
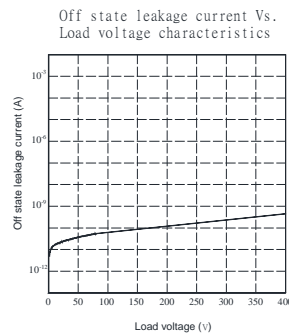
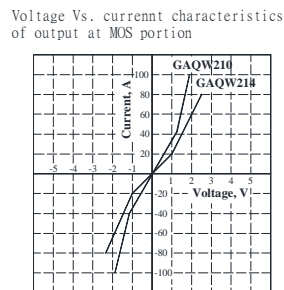
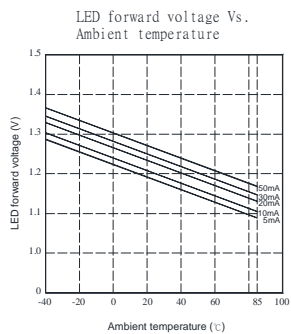
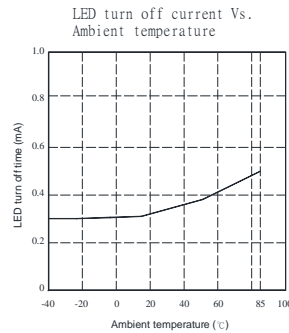
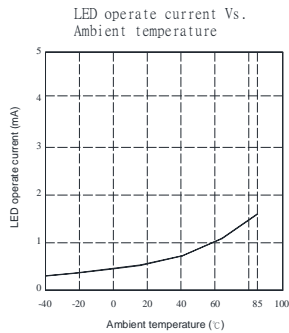
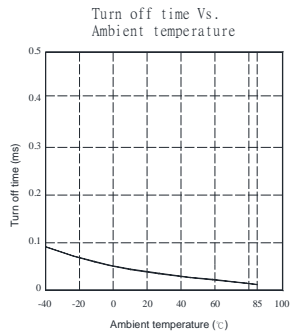
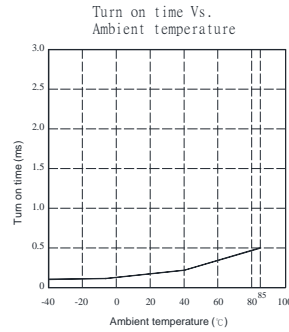
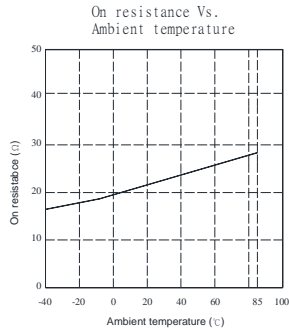
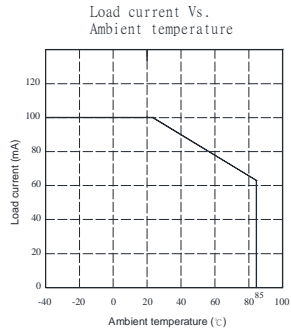

Dimensions

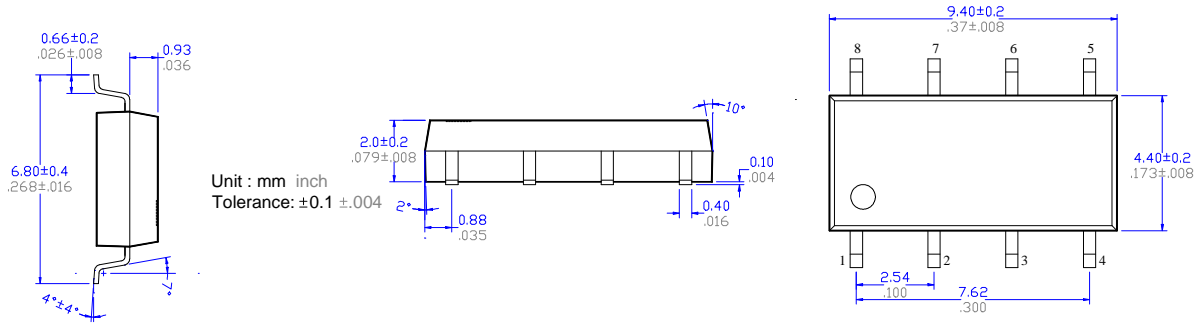

Recommended mounting pad (TOP VIEW)

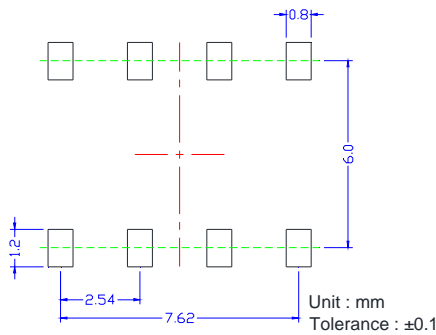

Marking

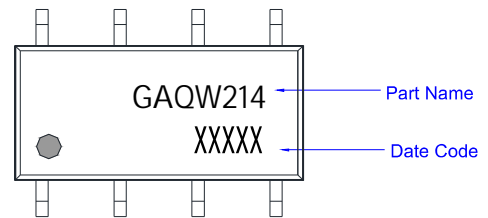

Tape dimensions

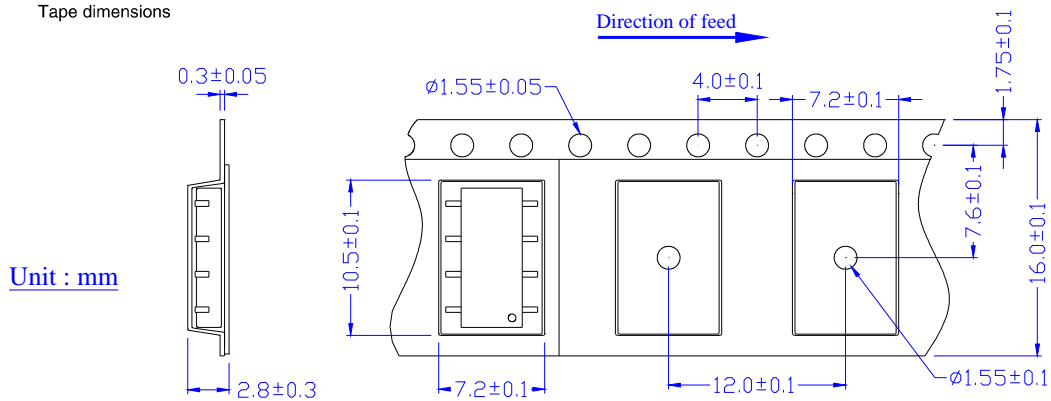

Dimensions of tape reel

