

Surface Mount Transient Voltage Suppressor Rectifiers
Reverse Voltage 3.30 V
400 Watt Peak Pulse Power

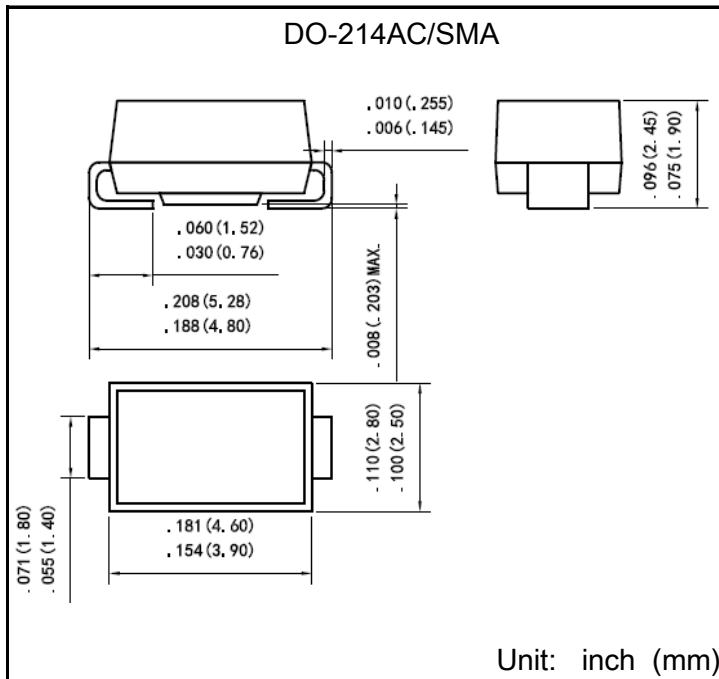

Features

- Glass passivated chip
- 400 W peak pulse power capability with a 10/1000 us waveform, repetitive rate (duty cycle):0.01 %
- Excellent clamping capability
- Low reverse leakage
- Very fast response time
- Lead and body according with RoHS standard

Mechanical Data

- Case: DO-214AC/SMA Molded plastic
- Lead: Solderable per MIL-STD-750, method 2026
- Epoxy: UL 94V-0 rate flame retardant
- Polarity: Color band denotes cathode end except Bipolar
- Mounting position: Any

Maximum Ratings & Characteristics Ratings at 25°C ambient temperature unless otherwise specified.

Parameter	Symbols	Value	Unit
Peak power dissipation with a 10/1000 us waveform ⁽¹⁾	P_{PP}	400	W
Peak pulse current with a 10/1000 us waveform ⁽¹⁾	I_{PP}	54.8	A
Power dissipation on infinite heatsink at $T_L = 75^\circ\text{C}$	P_D	1.0	W
Peak forward surge current, 8.3 ms single half sinewave unidirectional only ⁽²⁾	I_{FSM}	50	A
Maximum instantaneous forward voltage at 10 A for unidirectional only	V_F	3.5	V
Operating junction and storage temperature range	T_J, T_{STG}	-55 to +150	°C

Note:

1) Non-repetitive current pulse per Fig.5 and derated above $T_A = 25^\circ\text{C}$ per Fig.1 ;

2) Measured on 8.3 ms single half sine-wave or equivalent square wave, duty cycle = 4 pulses per minute maximum ;

Part Number		Device Marking Code		Reverse Stand-off Voltage	Breakdown Voltage $V_{BR} @ I_T$		Test Current	Max. Clamping Voltage @ I_{PP}	Max. Peak Pulse Current	Max. Reverse Leakage @ V_{RWM}
UNI-POLAR	BI-POLAR	UNI	BI	$V_{RWM}(V)$	Min.(V)	Max.(V)	$I_T(mA)$	$V_{C,MAX}(V)$	$I_{PP}(A)$	$I_R(\mu A)$
SMAJ3.3A	SMAJ3.3CA	3V3	DY	3.3	4.20	6.55	10	7.3	54.80	200



Ratings and Characteristics Curves (TA=25°C unless otherwise noted)

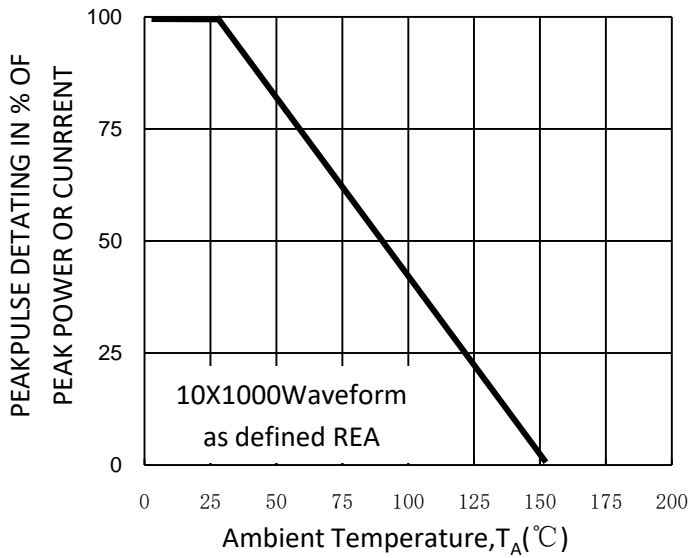

Fig. 1-Pulse Derating Curve

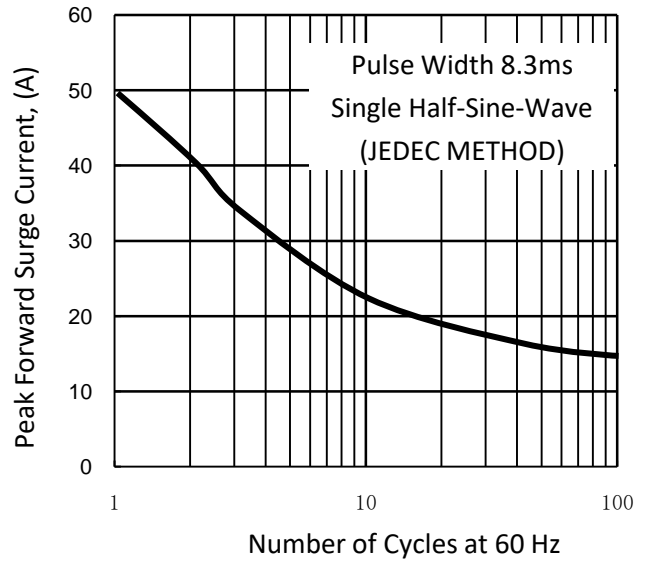

Fig. 2-Maximum Non-Repetitive Surge Current

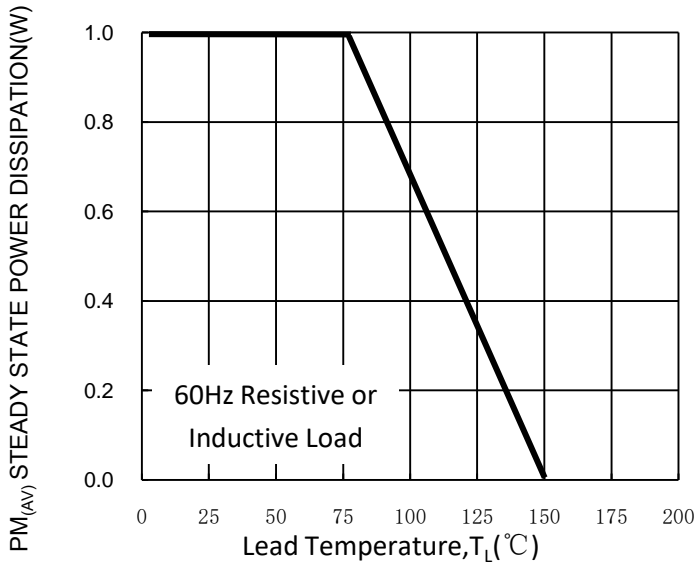

Fig. 3-Steady State Power Derating Curve

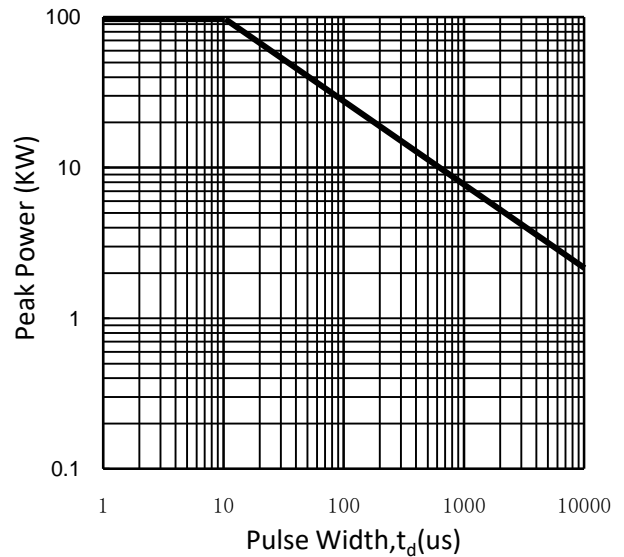

Fig. 4-Peak Pulse Power Rating Curve

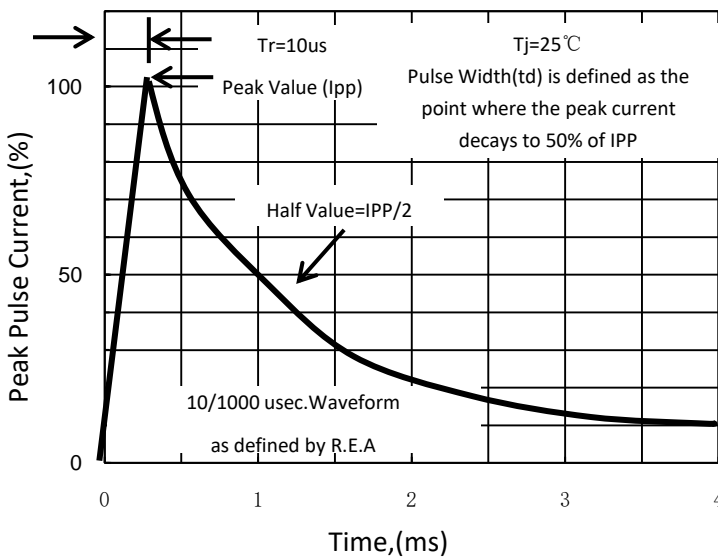

Fig. 5-Pulse Waveform

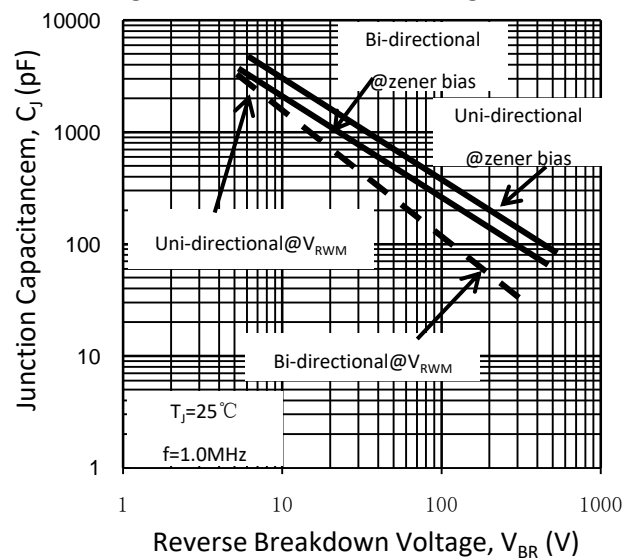

Fig. 6-Typical Junction Capacitance