3.0A, Low Voltage μ Cap LDO Regulator

Features

- 3A Minimum Output Current
- 500 mV Maximum Dropout Voltage over Temperature
 - Recommended for 3.0V to 2.5V Conversion
 - Recommended for 2.5V to 1.8V, 1.65V, or 1.5V Conversion
- Stable with Ceramic or Tantalum Capacitors
- Wide Input Voltage Range
 - V_{IN} : 2.25V to 6.0V
- +1.0% Initial Output Tolerance
- Fixed and Adjustable Output Voltages:
 - MIC37300: 3-pin S-PAK Fixed Voltages
 - MIC37301: 5-pin S-PAK or 8-pin ePad SOIC Fixed Voltages with Flag
 - MIC37302: 5-pin Adjustable Voltage
 - MIC37303: 8-pin ePad SOIC, DFN Adjustable Voltage with Flag
- Excellent Line and Load Regulation Specifications
- Thermal Shutdown and Current Limit Protection
- Reverse-Leakage Protection
- Low Profile S-PAK Package

Applications

- LDO Linear Regulator for Low Voltage Digital IC
- PC Add-In Cards
- PowerPC Power Supplies
- High Efficiency Linear Power Supplies
- SMPS Post Regulator
- Multimedia and PC Processor Supplies
- Battery Chargers
- Low Voltage Microcontrollers and Digital Logic

General Description

The MIC37300/01/02/03 is a 3.0A low-dropout linear voltage regulator that provides a low voltage, high current output with a minimum number of external components. It offers high precision, ultra-low dropout (500 mV over temperature), and low ground current.

The MIC37300/01/02/03 operates from an input of 2.25V to 6.0V. It is designed to drive digital circuits requiring low-voltage at high currents (i.e., PLDs, DSP, microcontroller, etc.). It is available in fixed and adjustable output voltages. Fixed voltages include 1.5V, 1.8V, 2.5V, and 3.3V. The adjustable version is capable of 1.24V to 5.5V.

Features of the MIC37300/01/02/03 LDO include thermal and current limit protection, and reverse current protection. Logic enable and error flag pins are available on the 5-pin version.

Junction temperature range of the MIC37300/01/02/03 is from -40°C to $+125^{\circ}\text{C}$.

For applications requiring input voltage greater than 6.0V, see the MIC3910x, MIC3915x, MIC3930x, and MIC3950x LDOs.

MIC37300/01/02/03

Typical Application Circuits

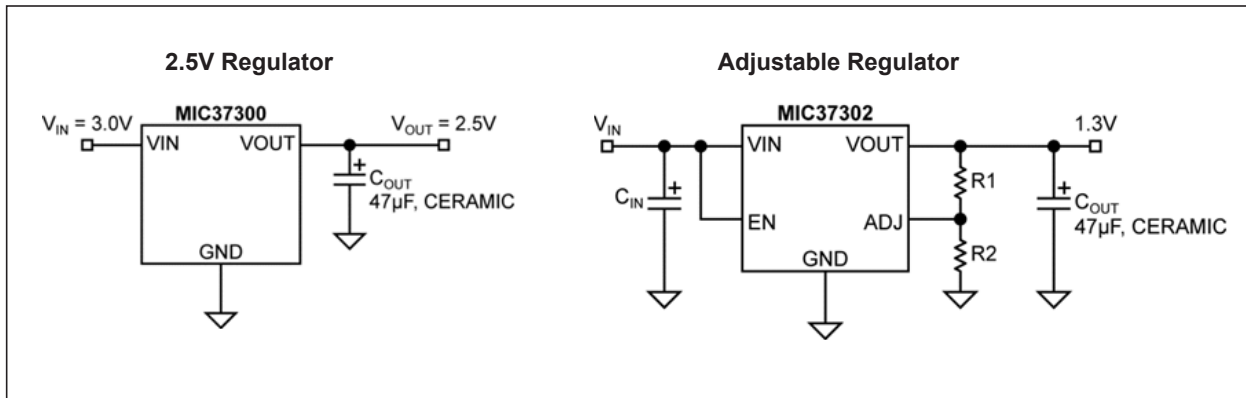

Package Types

S-PAK-5 (R)
(Top View)

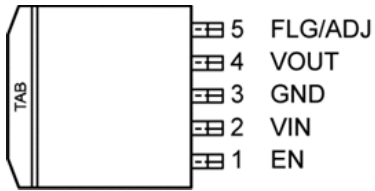

S-PAK-3 (R)
(Top View)

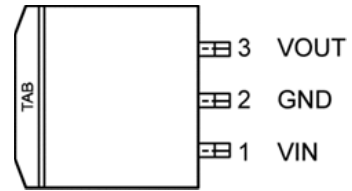

TO-263-5 (U)
(Top View)

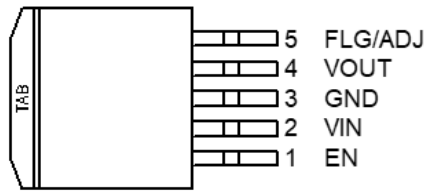

ePad SOIC-8 (ME)
(Top View)

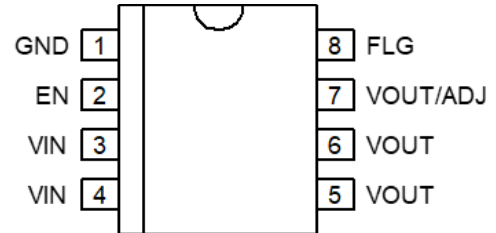

3 mm x 3 mm (DFN)
(Top View)

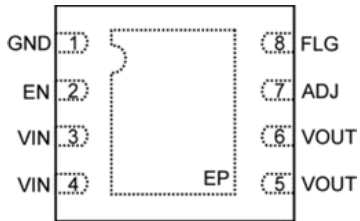

MIC37300/01/02/03

1.0 ELECTRICAL CHARACTERISTICS

Absolute Maximum Ratings †

Supply Voltage (V_{IN}).....	+6.5V
Enable Input Voltage (V_{EN}).....	+6.5V
Power Dissipation (P_D) (Note 1).....	Internally Limited
Junction Temperature (T_J).....	$-40^{\circ}\text{C} \leq T_J \leq +125^{\circ}\text{C}$
Storage Temperature (T_S).....	$-65^{\circ}\text{C} \leq T_J \leq +150^{\circ}\text{C}$
Lead Temperature (Soldering, 10s).....	260°C
ESD Rating (Note 2).....	2 kV

Operating Ratings ‡

Supply Voltage (V_{IN}).....	+2.25V to +6.0V
Enable Voltage (V_{EN}).....	0V to +6.0V
Junction Temperature (T_J).....	$-40^{\circ}\text{C} \leq T_J \leq +125^{\circ}\text{C}$
Package Thermal Resistance	
S-PAK (θ_{JA}).....	5.5°C/W
TO-263-5 (θ_{JC}).....	6.3°C/W
ePad SOIC-8 (θ_{JC}).....	16°C/W
3 mm x 3 mm DFN (θ_{JC}).....	29°C/W

† **Notice:** Stresses above those listed under “Absolute Maximum Ratings” may cause permanent damage to the device. This is a stress rating only and functional operation of the device at those or any other conditions above those indicated in the operational sections of this specification is not intended. Exposure to maximum rating conditions for extended periods may affect device reliability. Specifications are for packaged product only.

‡ **Notice:** The device is not guaranteed to function outside its operating ratings.

Note 1: $P_{D(max)} = (T_{J(max)} - T_A) \div \theta_{JA}$, where θ_{JA} depends upon the printed circuit layout. See “Section 4.0 “Application Information” section.

2: Devices are ESD sensitive. Handling precautions are recommended.

ELECTRICAL CHARACTERISTICS (Note 1)

Electrical Characteristics: $V_{IN} = V_{OUT} + 1V$; $V_{EN} = V_{IN}$; $I_L = 10\text{ mA}$; $T_A = 25^{\circ}\text{C}$, **Bold** values indicate $-40^{\circ}\text{C} < T_J < +125^{\circ}\text{C}$; unless otherwise specified.

Parameter	Symbol	Min.	Typ.	Max.	Units	Conditions
Output Voltage Accuracy	V_{OUT}	-1	—	+1	%	$I_L = 10\text{ mA}$
		-2	—	+2	%	$10\text{ mA} \leq I_{OUT} \leq I_{L(MAX)}$, $V_{OUT} + 1V \leq V_{IN} \leq 6V$
Output Voltage Line Regulation	$\Delta V_{OUT}/\Delta V_{IN}$	—	0.02	0.5	%	$V_{IN} = V_{OUT} + 1.0V$ to 6.0V; $I_L = 10\text{ mA}$
Output Voltage Load Regulation	$\Delta V_{OUT}/V_{OUT}$	—	0.2	1	%	$I_L = 10\text{ mA}$ to 3A
$V_{IN} - V_{OUT}$ Dropout Voltage (Note 2), (Note 5)	V_{DO}	—	175	350	mV	$I_L = 1.5A$ (For S-PAK-5, TO-263-5)
		—		400		$I_L = 1.5A$ (For e-Pad SOIC-8, DFN)
		—	300	500	mV	$I_L = 3.0A$ (For S-PAK-5, TO-263-5)
		—		550		$I_L = 3.0A$ (For e-Pad SOIC-8, DFN)
Ground Pin Current (Note 3)	I_{GND}	—	27	40 50	mA	$I_L = 3A$
Ground Pin Current In Shutdown	$I_{GND-SHDN}$	—	1.0	5	μA	$V_{IL} \leq 0.5V$, $V_{IN} = V_{OUT} + 1V$
Current Limit	I_{LIM}	—	4.75	6.5	A	$V_{OUT} = 0V$
Start-Up Time	t_{START}	—	170	500	μs	$V_{EN} = V_{IN}$, $I_{OUT} = 10\text{ mA}$, $C_{OUT} = 47\text{ }\mu\text{F}$

ELECTRICAL CHARACTERISTICS (Note 1) (CONTINUED)

Electrical Characteristics: $V_{IN} = V_{OUT} + 1V$; $V_{EN} = V_{IN}$; $I_L = 10 \text{ mA}$; $T_A = 25^\circ\text{C}$, **Bold** values indicate $-40^\circ\text{C} < T_J < +125^\circ\text{C}$; unless otherwise specified.

Parameter	Symbol	Min.	Typ.	Max.	Units	Conditions
Enable Input						
Enable Input Threshold	V_{EN}	2.25	—	—	V	Regulator Enable
		—	—	0.8		Regulator Shutdown
Enable Pin Input Current	I_{EN}	—	—	2 4	μA	$V_{IL} \leq 0.8\text{V}$ (Regulator Shutdown)
		1	15	30 75		$V_{IH} \geq 2.25\text{V}$ (Regulator Enable)
Flag Output						
Output Leakage Current	$I_{FLG(LEAK)}$	—	—	1	μA	$V_{OH} = 6\text{V}$
		—	—	2		
Output Low Voltage (Note 4)	$V_{FLG(LO)}$	—	210	400 500	mV	$V_{IN} = 2.25\text{V}$, $I_{OL} = 250 \mu\text{A}$
Low Threshold	V_{FLG}	93	—	—	%	% of V_{OUT} Below Nominal
High Threshold		—	—	99.2		% of V_{OUT} Below Nominal
Hysteresis		—	2	—		—
MIC37302 Only						
Reference Voltage	V_{REF}	1.228	1.240	1.252	V	—
		1.215		1.265		
Adjust Pin Bias Current	I_{ADJ}	—	40	80	nA	—
				120		

- 1: Specification for packaged product only.
- 2: $V_{DO} = V_{IN} - V_{OUT}$ when V_{OUT} decreases to 98% of its nominal output voltage with $V_{IN} = V_{OUT} + 1\text{V}$. For output voltages below 1.75V, dropout voltage specification does not apply due to a minimum input operating voltage of 2.25V.
- 3: I_{GND} is the ground current. $I_{IN} = I_{GND} + I_{OUT}$.
- 4: For a 2.5V device, $V_{IN} = 2.25\text{V}$ (device is in dropout).
- 5: Limits specified down to:
 - $V_{IN} = 2.25\text{V}$ for $0^\circ\text{C} \leq T_A \leq +125^\circ\text{C}$
 - $V_{IN} = 2.35\text{V}$ for $0^\circ\text{C} > T_A \geq -40^\circ\text{C}$

MIC37300/01/02/03

TEMPERATURE SPECIFICATIONS (Note 1)

Parameters	Sym.	Min.	Typ.	Max.	Units	Conditions
Temperature Ranges						
Lead Temperature	—	—	—	260	°C	(soldering, 10 sec.)
Junction Temperature	T_J	-40	—	+125	°C	—
Storage Temperature Range	T_S	-65	—	+150	°C	—
Package Thermal Resistances						
Thermal Resistance SPAK-5	θ_{JC}	—	5.5	—	°C/W	—
Thermal Resistance TO-263-5	θ_{JC}	—	6.3	—	°C/W	—
Thermal Resistance ePad SOIC-8	θ_{JC}	—	16	—	°C/W	—
Thermal Resistance 3 mm x 3 mm DFN	θ_{JC}	—	29	—	°C/W	—

Note 1: The maximum allowable power dissipation is a function of ambient temperature, the maximum allowable junction temperature and the thermal resistance from junction to air (i.e., T_A , T_J , θ_{JA}). Exceeding the maximum allowable power dissipation will cause the device operating junction temperature to exceed the maximum +125°C rating. Sustained junction temperatures above +125°C can impact the device reliability.

2.0 TYPICAL PERFORMANCE CURVES

Note: The graphs and tables provided following this note are a statistical summary based on a limited number of samples and are provided for informational purposes only. The performance characteristics listed herein are not tested or guaranteed. In some graphs or tables, the data presented may be outside the specified operating range (e.g., outside specified power supply range) and therefore outside the warranted range.

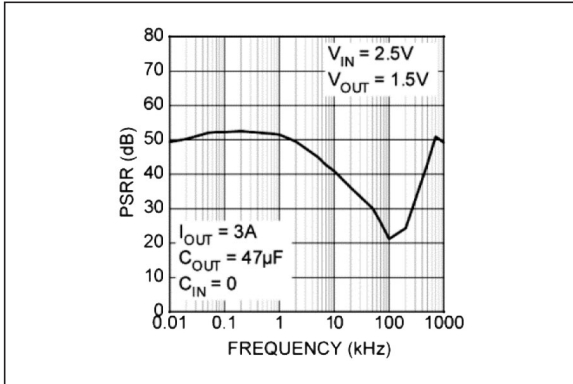

FIGURE 2-1: Power Supply Rejection Ratio.

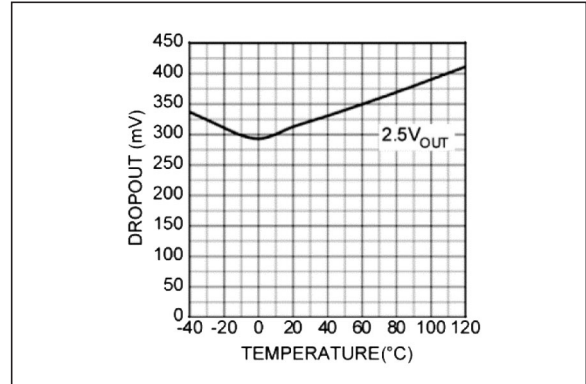

FIGURE 2-4: Dropout vs. Temperature.

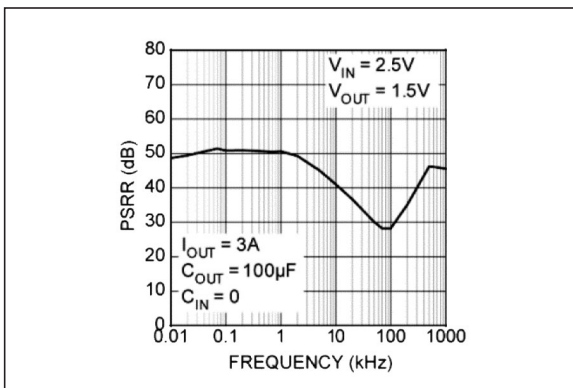

FIGURE 2-2: Power Supply Rejection Ratio.

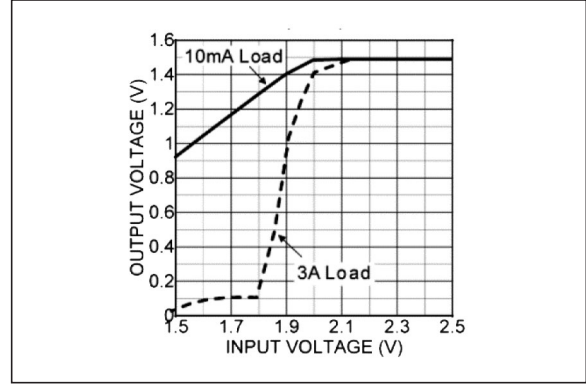

FIGURE 2-5: Dropout Characteristics (1.5V).

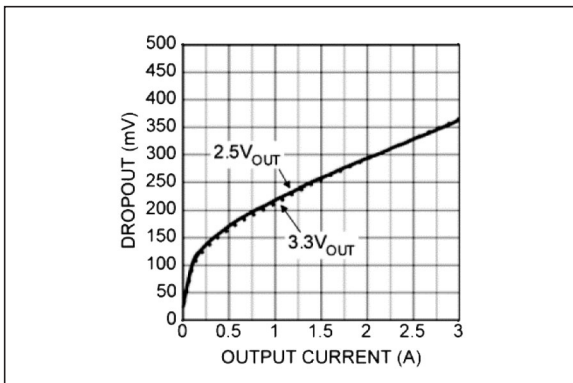

FIGURE 2-3: Dropout vs. Output Current.

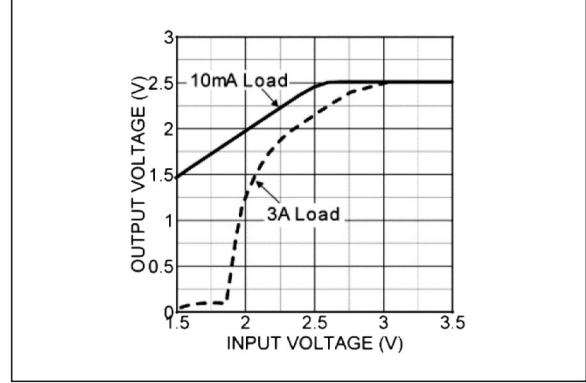

FIGURE 2-6: Dropout Characteristics (2.5V).

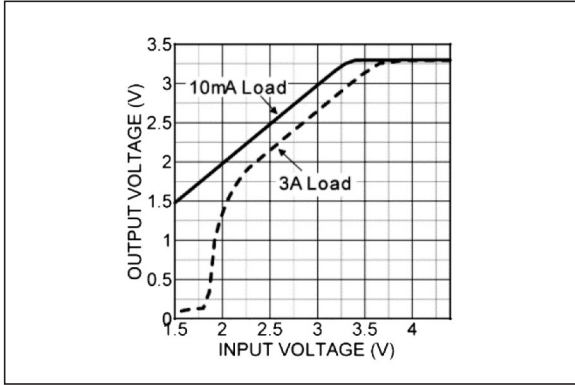

FIGURE 2-7: Dropout Characteristics (3.3V).

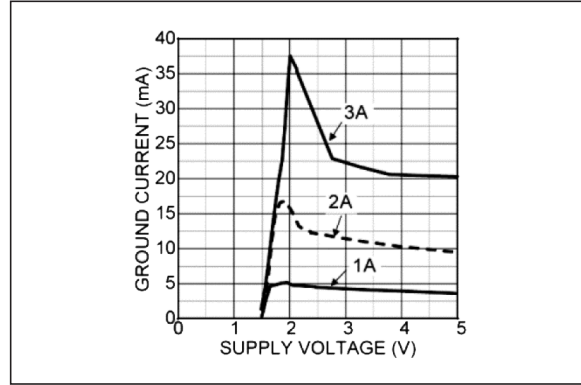

FIGURE 2-10: Ground Current vs. Supply Voltage (1.5V).

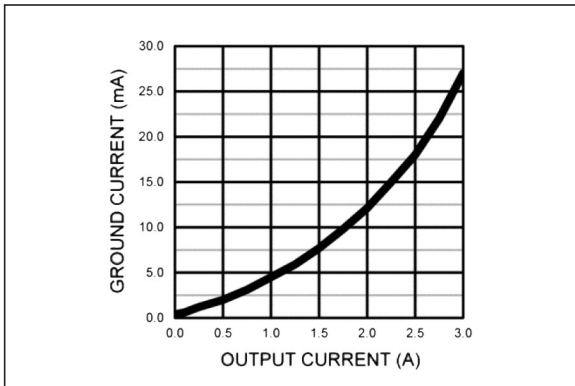

FIGURE 2-8: Ground Current vs. Output Current.

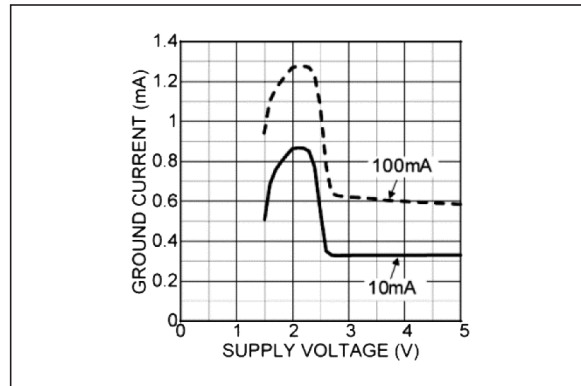

FIGURE 2-11: Ground Current vs. Supply Voltage (2.5V).

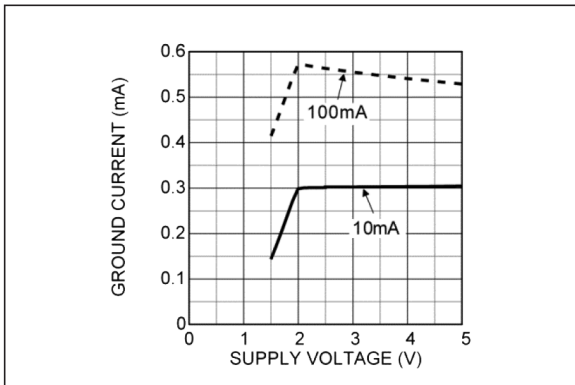

FIGURE 2-9: Ground Current vs. Supply Voltage (1.5V).

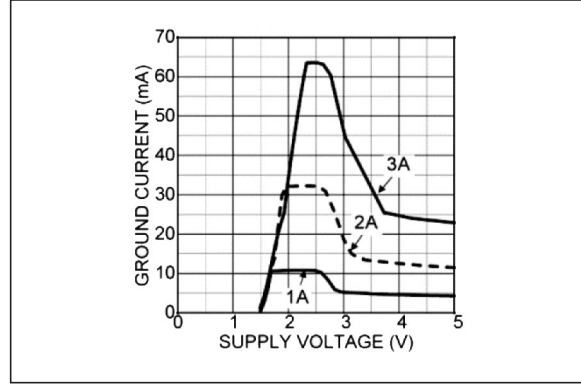

FIGURE 2-12: Ground Current vs. Supply Voltage (2.5V).

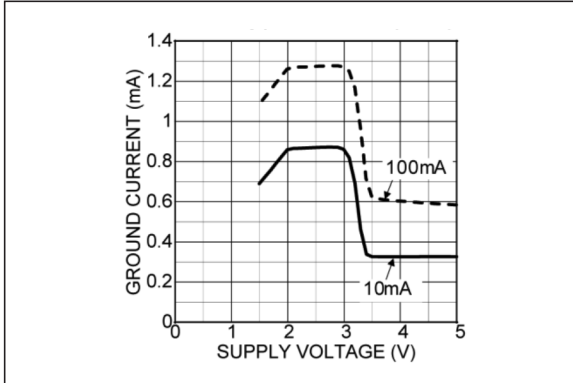

FIGURE 2-13: Ground Current vs. Supply Voltage (3.3V).

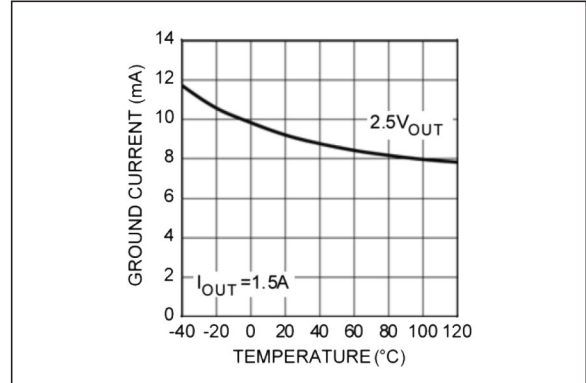

FIGURE 2-16: Ground Current vs. Temperature.

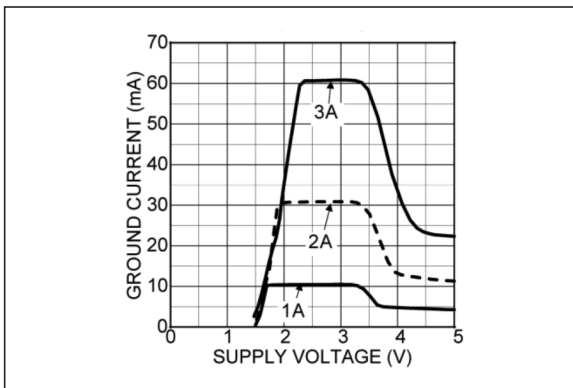

FIGURE 2-14: Ground Current vs. Supply Voltage (3.3V).

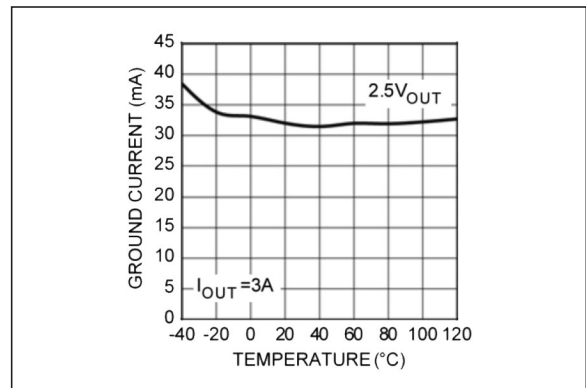

FIGURE 2-17: Ground Current vs. Temperature.

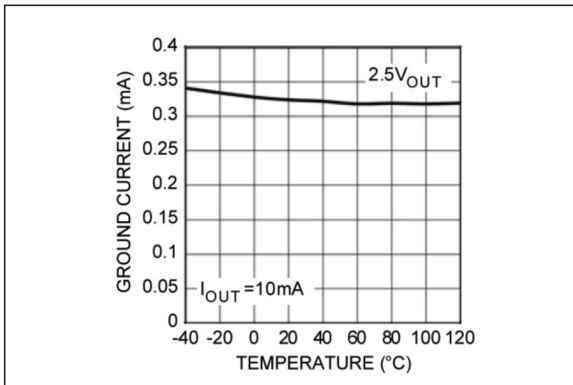

FIGURE 2-15: Ground Current vs. Temperature.

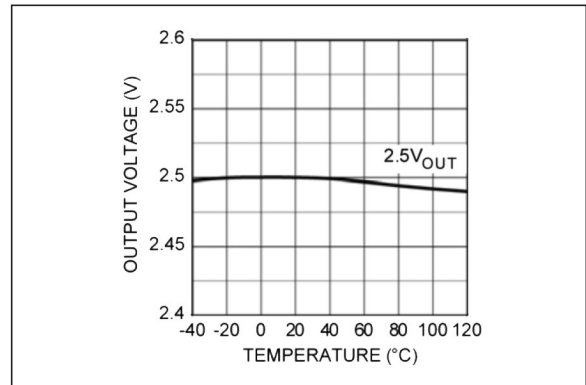

FIGURE 2-18: Output Voltage vs. Temperature.

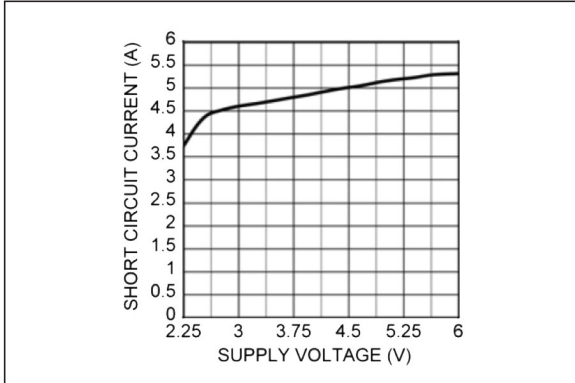

FIGURE 2-19: Short-Circuit Current vs. Supply Voltage.

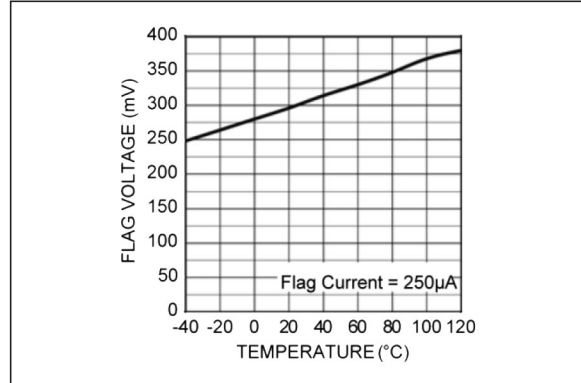

FIGURE 2-22: Flag Low-Voltage vs. Temperature.

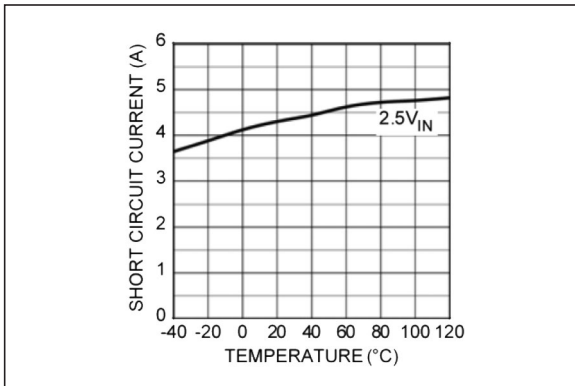

FIGURE 2-20: Short-Circuit Current vs. Temperature.

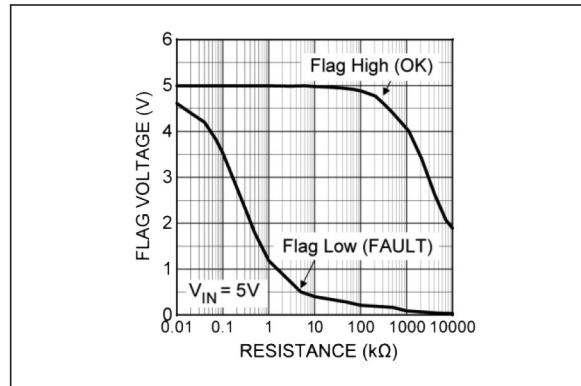

FIGURE 2-23: Error Flag Pull-Up Resistor.

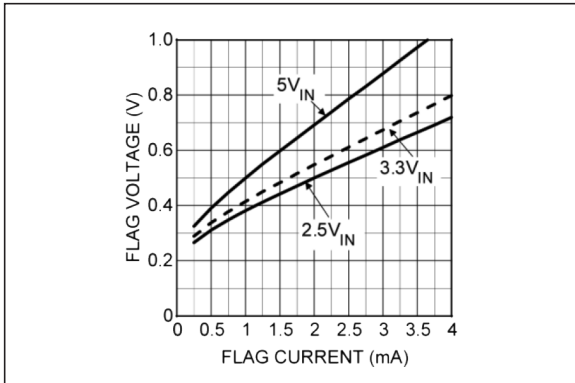

FIGURE 2-21: Flag Voltage vs. Flag Current.

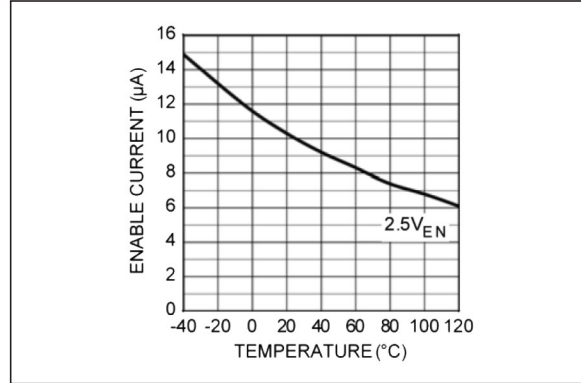

FIGURE 2-24: Enable Current vs. Temperature.

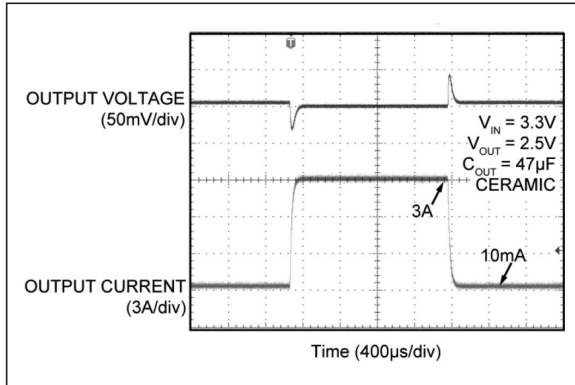

FIGURE 2-25: Load Transient Response.

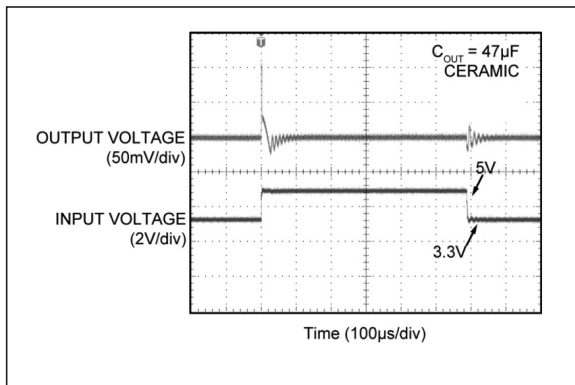

FIGURE 2-26: Line Transient Response.

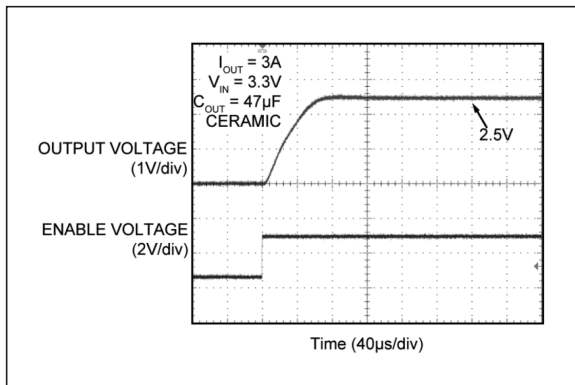

FIGURE 2-27: Enable Transient Response.

MIC37300/01/02/03

3.0 PIN DESCRIPTIONS

The descriptions of the pins are listed in [Table 3-1](#).

TABLE 3-1: PIN FUNCTION TABLE

S-PAK-5 TO-263-5	S-PAK-3	ePAD SOIC-8 DFN	Pin Name	Description
1	—	2	EN	Enable (Input): CMOS compatible control input. Logic high = enable, Logic low = shutdown. Do not leave floating.
2	1	3, 4	VIN	Input voltage that supplies current to the output power device.
3	2	1	GND	Ground: TAB is connected to ground.
4	3	5, 6, 7 (Fixed) 5, 6, (Adj.)	VOUT	Regulator output.
5 (Fixed)	—	8	FLG	Flag (Output): Open collector output. Active LOW indicates an output fault condition.
5 (Adj)	—	7 (Adj.)	ADJ	Adjustable regulator feedback input: Connect to resistor voltage driver.
—	—	EP	ePad	Connect to GND for best thermal performance.

4.0 APPLICATION INFORMATION

The MIC37300/01/02/03 is a high-performance low dropout voltage regulator suitable for moderate to high current regulator applications. The 500 mV dropout voltage at full load and over temperature makes it especially valuable in battery-powered systems and as high-efficiency noise filters in post regulator applications. Unlike older NPN-pass transistor designs, where the minimum dropout voltage is limited by the base-to-emitter voltage drop and collector-to-emitter saturation voltage, dropout performance of the PNP output of these devices is limited only by the low V_{CE} saturation voltage.

A trade-off for the low dropout voltage is a varying base drive requirement. Microchip's Super β PNP process reduces this drive requirement to only 2% to 5% of the load current.

The MIC37100/01/02 regulator is fully protected from damage due to fault conditions. Linear current limiting is provided. Output current during overload conditions is constant. Thermal shutdown disables the device when the die temperature exceeds the maximum safe operating temperature. The output structure of these regulators allows voltages in excess of the desired output voltage to be applied without reverse current flow.

4.1 Thermal Design

Linear regulators are simple to use. The most complicated design parameters to consider are thermal characteristics. Thermal design requires the following application specific parameters:

- Maximum ambient temperature (T_A)
- Output current (I_{OUT})
- Output voltage (V_{OUT})
- Input voltage (V_{IN})
- Ground current (I_{GND})

First, calculate the power dissipation of the regulator and the device parameters from [Electrical Characteristics](#) section or the [Typical Performance Curves](#) section.

EQUATION 4-1:

$$P_D = (V_{IN} - V_{OUT})I_{OUT} + V_{IN} \times I_{GND}$$

Then the heat sink thermal resistance is determined with [Equation 4-2](#):

EQUATION 4-2:

$$\theta_{SA} = ((T_{J(MAX)} - T_A)/P_D) - (\theta_{JC} + \theta_{CS})$$

Where:

$$T_{J(MAX)} = <125^\circ\text{C}$$

$$\theta_{CS} = \text{between } 0^\circ\text{C/W and } 2^\circ\text{C/W.}$$

The heat sink may be significantly reduced in applications where the minimum input voltage is known and is large compared with the dropout voltage. Use a series input resistor to drop excessive voltage and distribute the heat between this resistor and the regulator. The low dropout properties of Microchip's Super β PNP regulators allow significant reductions in regulator power dissipation and the associated heat sink without compromising performance. When this technique is employed, a capacitor of at least 1.0 μF is needed directly between the input and regulator ground.

4.2 Output Capacitor

The MIC37300/01/02/03 requires an output capacitor for stable operation. As a μCap LDO, the MIC37300/01/02/03 can operate with ceramic output capacitors as long as the amount of capacitance is 47 μF or greater. For values of output capacitance lower than 47 μF , the recommended ESR range is 200 m Ω to 2 Ω . The minimum value of output capacitance recommended for the MIC37300 is 10 μF .

For 47 μF or greater, the ESR range recommended is less than 1 Ω . Ultra-low ESR, ceramic capacitors are recommended for output capacitance of 47 μF or greater to help improve transient response and noise reduction at high frequency. X7R/X5R dielectric-type ceramic capacitors are recommended because of their temperature performance. X7R-type capacitors change capacitance by 15% over their operating temperature range and are the most stable type of ceramic capacitors. Z5U and Y5V dielectric capacitors change value by as much as 50% and 60%, respectively, over their operating temperature ranges. To use a ceramic chip capacitor with Y5V dielectric, the value must be much higher than an X7R ceramic capacitor to ensure the same minimum capacitance over the equivalent operating temperature range.

MIC37300/01/02/03

4.3 Input Capacitor

An input capacitor of 1.0 μF or greater is recommended when the device is more than 4 inches away from the bulk supply capacitance, or when the supply is a battery. Small, surface-mount chip capacitors can be used for the bypassing. The capacitor should be placed within 1 inch of the device for optimal performance. Larger values will help to improve ripple rejection by bypassing the input to the regulator, further improving the integrity of the output voltage.

4.4 Transient Response and 3.3V to 2.5V or 2.5V to 1.8V, 1.65V, or 1.5V Conversions

The MIC37300/01/02/03 has excellent transient response to variations in input voltage and load current. The device has been designed to respond quickly to load current variations and input voltage variations. Large output capacitors are not required to obtain this performance. A standard 47 μF output capacitor, is all that is required. Larger values help to improve performance even further.

By virtue of its low dropout voltage, this device does not saturate into dropout as readily as similar NPN-based designs. When converting from 3.3V to 2.5V or 2.5V to 1.8V, or lower, the NPN based regulators are already operating in dropout, with typical dropout requirements of 1.2V or greater. To convert down to 2.5V or 1.8V without operating in dropout, NPN-based regulators require an input voltage of 3.7V at the very least. The MIC37100 regulator will provide excellent performance with an input as low as 3.0V or 2.25V respectively. This gives the PNP based regulators a distinct advantage over older, NPN based linear regulators.

4.5 Minimum Load Current

The MIC37300/01/02/03 regulator is specified between finite loads. If the output current is too small, then the leakage currents dominate and the output voltage rises. A 10 mA minimum load current is necessary for proper operation. For adjustable regulators, this can be accomplished by selecting the feedback resistors to load the output with 10 mA.

4.6 Error Flag

The MIC37301 and MIC37303 feature an error flag circuit that monitors the output voltage and signals an error condition when the voltage is 5% below the nominal output voltage. The error flag is an open collector output that can sink 10 mA during a fault condition.

Low output voltage can be caused by a number of problems, including an overcurrent fault (device in current limit) or low input voltage. The flag is inoperative during overtemperature shutdown.

4.7 Enable Input

The MIC37301/02/03 also features an enable input for on/off control of the device. Its shutdown state draws “zero” current (only microamperes of leakage). The enable input is TTL/CMOS compatible for simple logic interface, but can be connected up to V_{IN} . When enabled, it draws approximately 15 μA .

4.8 Adjustable Regulator Design

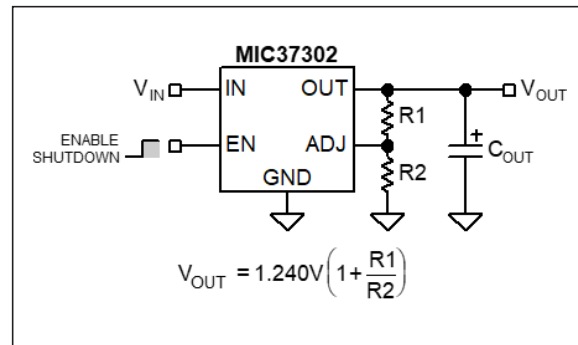

FIGURE 4-1: Adjustable Regulator with Resistors.

The MIC37302 and MIC37303 allow programming the output voltage anywhere between 1.24V and the 5.5V maximum operating rating of the family. Two resistors are used. Resistors can be quite large, up to 1 M Ω , because of the very high input impedance and low bias current of the sense comparator. The resistor values are calculated by:

EQUATION 4-3:

$$R1 = R2 \left(\frac{V_{\text{OUT}}}{1.240} - 1 \right)$$













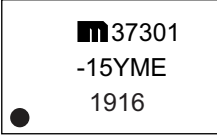

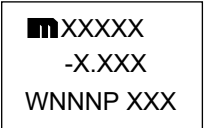



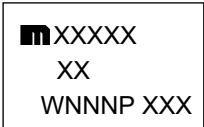

Where:

V_{OUT} = The desired output voltage.

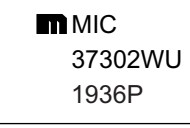
Figure 4-1 shows the component definition. Applications with widely varying load currents may scale the resistors to draw the minimum load current required for proper operation.

5.0 PACKAGING INFORMATION

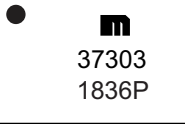
5.1 Package Marking Information

8-Lead SOIC*	Example
 <p>  XXXXX -XXXXX WNNN </p>	 <p>  37301 -15YME 1916 </p>
3-Lead S-PAK*	Example
 <p>  XXXXX -X.XXX WNNNP XXX </p>	 <p>  37300 -1.5WR 1910P USA </p>
5-Lead S-PAK*	Example
 <p>  XXXXX XX WNNNP XXX </p>	 <p>  37302 WR 1930P USA </p>
5-Lead TO-263*	Example
 <p>  XXX XXXXXXXX WNNNP </p>	 <p>  MIC 37302WU 1936P </p>
8-Lead DFN*	Example
 <p>  XXXXX WNNNP </p>	 <p>  37303 1836P </p>

Legend:	XX...X Product code or customer-specific information Y Year code (last digit of calendar year) YY Year code (last 2 digits of calendar year) WW Week code (week of January 1 is week '01') NNN Alphanumeric traceability code (e3) Pb-free JEDEC® designator for Matte Tin (Sn) * This package is Pb-free. The Pb-free JEDEC designator (e3) can be found on the outer packaging for this package. ●, ▲, ▼ Pin one index is identified by a dot, delta up, or delta down (triangle mark).
----------------	--

Note: In the event the full Microchip part number cannot be marked on one line, it will be carried over to the next line, thus limiting the number of available characters for customer-specific information. Package may or may not include the corporate logo.

Underbar (_) and/or Overbar (¯) symbol may not be to scale.

MIC37300/01/02/03

8-Lead SOIC-8 (ME) Package Outline and Recommended Land Pattern

TITLE

8 LEAD SOICN EPAD PACKAGE OUTLINE & RECOMMENDED LAND PATTERN

DRAWING #	SOICNEP-8LD-PL-1	UNIT	INCH [MM]
-----------	------------------	------	-----------

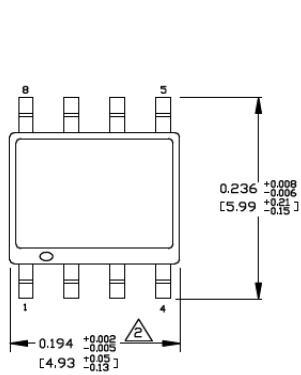

TOP VIEW

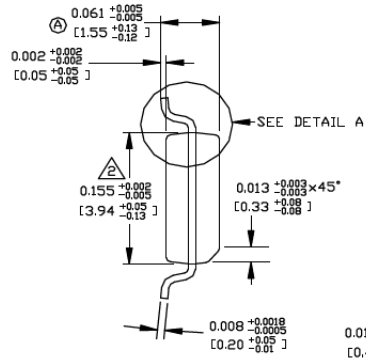

END VIEW

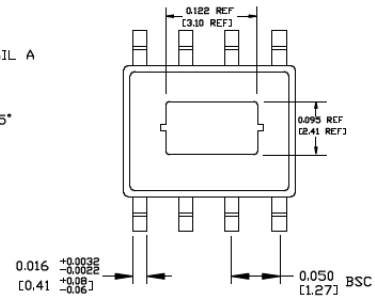

BOTTOM VIEW

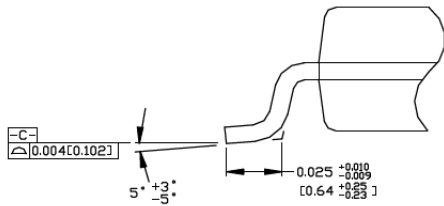

DETAIL "A"

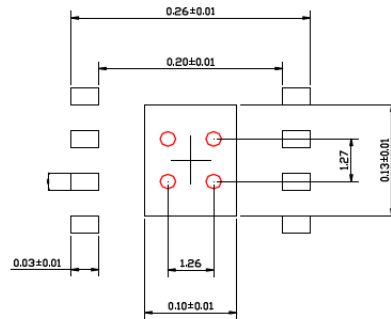

RECOMMENDED LAND PATTERN

NOTE:

1. DIMENSION DOES NOT INCLUDE MOLD FLASH OR PROTRUSIONS, EITHER OF WHICH SHALL EXCEED 0.006 INCHES PER SIDE
2. RED CIRCLES IN LAND PATTERN REPRESENT THERMAL VIAS. RECOMMENDED SIZE IS 0.30-0.30MM IN DIAMETER AND SHOULD BE CONNECTED TO GND FOR MAXIMUM THERMAL PERFORMANCE

Note: For the most current package drawings, please see the Microchip Packaging Specification located at <http://www.microchip.com/packageing>.

5-Lead TO-263-5 (U) Package Outline and Recommended Land Pattern

TITLE

5 LEAD T0263 PACKAGE OUTLINE & RECOMMENDED LAND PATTERN

DRAWING #	T0263-5LD-PL-1	UNIT	INCH/MM
------------------	----------------	-------------	---------

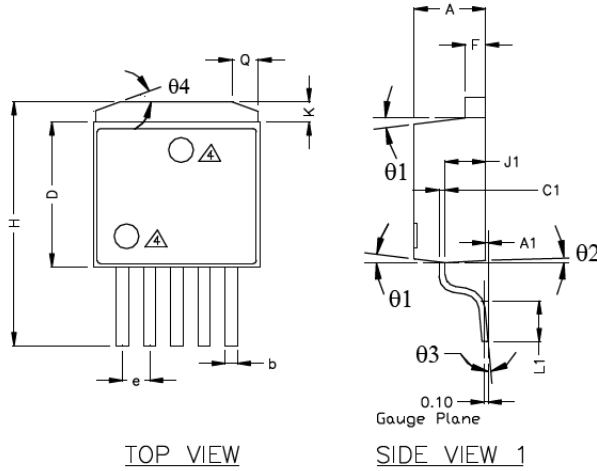

TOP VIEW

SIDE VIEW 1

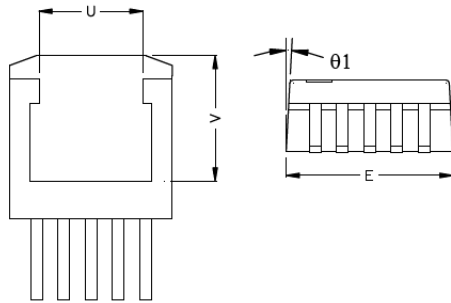

BOTTOM VIEW

SIDE VIEW 2

POS	INCH		MM	
	MIN	MAX	MIN	MAX
A	0.170	0.181	4.318	4.597
A1	0.000	0.012	0.000	0.305
b	0.026	0.036	0.660	0.914
C1	0.012	0.023	0.305	0.584
D	0.330	0.361	8.392	9.169
E	0.396	0.420	10.058	10.668
e	0.062	0.072	1.575	1.829
F	0.045	0.055	1.143	1.397
H	0.575	0.625	14.605	15.875
J1	0.080	0.120	2.032	3.048
K	0.045	0.066	1.143	1.676
L1	0.090	0.110	2.286	2.794
theta 1	3°	10°	3°	10°
theta 2	1°	7°	1°	7°
theta 3	0°	8°	0°	8°
theta 4	18°	22°	18°	22°
Q	0.055	0.075	1.397	1.905
U	0.256	Ref.	6.502	Ref.
V	0.305	Ref.	7.747	Ref.

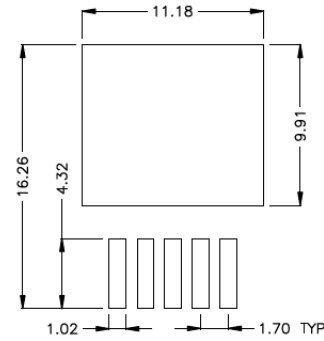

RECOMMENDED LAND PATTERN
(UNIT : mm)

- NOTE:
1. PACKAGE OUTLINE EXCLUSIVE OF MOLD FLASH & METAL BURR.
 2. PACKAGE OUTLINE INCLUSIVE OF PLATING THICKNESS.
 3. FOOT LENGTH USING GAUGE PLANE METHOD MEASUREMENT 0.010"
 4. PACKAGE TOP MARK MAY BE IN TOP CENTER OR LOWER LEFT CORNER
 5. ALL DIMENSIONS ARE IN INCHES/MILLIMETERS.

Note: For the most current package drawings, please see the Microchip Packaging Specification located at <http://www.microchip.com/packaging>.

MIC37300/01/02/03

3-Lead S-PAK (R) Package Outline and Recommended Land Pattern

TITLE

3 LEAD SPAK PACKAGE OUTLINE & RECOMMENDED LAND PATTERN

DRAWING #	SPAK-3LD-PL-1	UNIT	INCH/MM
------------------	---------------	-------------	---------

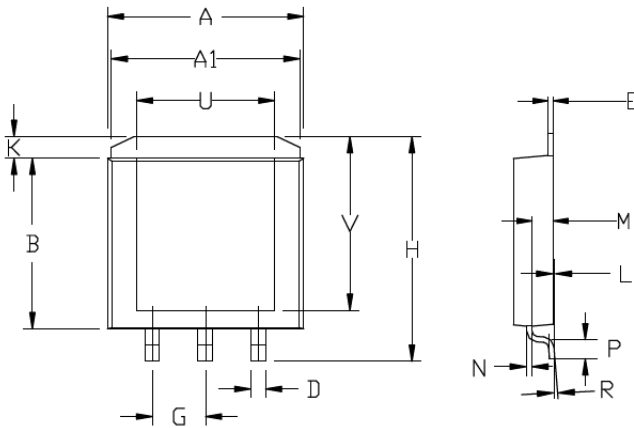

	INCHES		MILLIMETERS	
A	0.365	0.375	9.27	9.52
A1	0.350	0.360	8.89	9.14
B	0.310	0.320	7.87	8.13
C	0.070	0.080	1.78	2.03
D	0.025	0.031	0.63	0.79
E	0.010	BSC	0.25	BSC
G	0.100	BSC	2.54	BSC
H	0.410	0.420	10.41	10.67
K	0.030	0.050	0.76	1.27
L	0.001	0.005	0.03	0.13
M	0.035	0.045	0.89	1.14
N	0.010	BSC	0.25	BSC
P	0.031	0.041	0.79	1.04
R	0"	6"	0"	6"
U	0.256	BSC	6.50	BSC
V	0.316	BSC	8.03	BSC

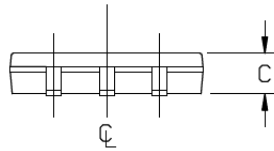

- NOTE:
1. DIMENSION DOES NOT INCLUDE MOLD FLASH OR PROTRUSIONS.
 2. DIMENSION INCLUDES PLATING THICKNESS, SOLDER MASK OPENING
 3. RED CIRCLES IN LAND PATTERN REPRESENT THERMAL VIA, 0.30MM IN DIAMETER & SHOULD BE CONNECTED TO GND FOR MAXIMUM PERFORMANCE
 4. GREEN RECTANGLES IN LAND PATTERN REPRESENT SOLDER STENCIL OPENING (OPTIONAL), 1.50X1.50MM.

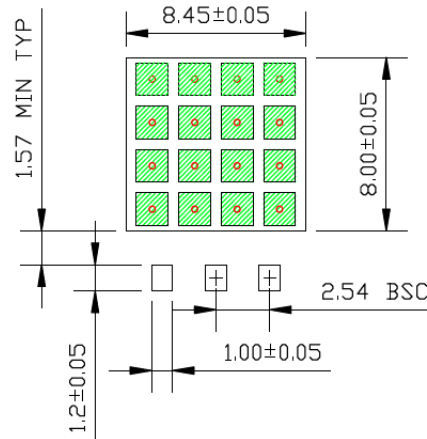

RECOMMENDED LAND PATTERN (UNIT: MM)

Note: For the most current package drawings, please see the Microchip Packaging Specification located at <http://www.microchip.com/packaging>.

5-Lead S-PAK (R) Package Outline and Recommended Land Pattern

TITLE

5 LEAD SPAK PACKAGE OUTLINE & RECOMMENDED LAND PATTERN

DRAWING #	SPAK-5LD-PL-1	UNIT	MM
------------------	---------------	-------------	----

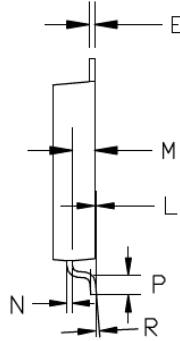
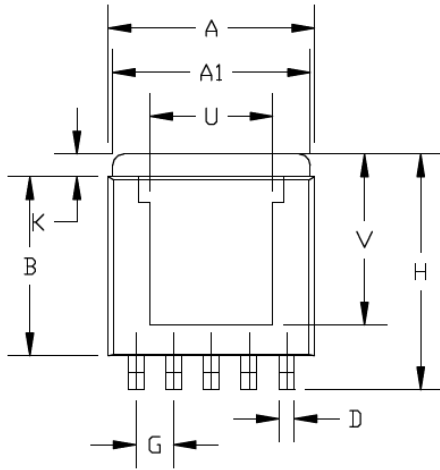

	INCHES		MILLIMETERS	
A	0.365	0.375	9.27	9.52
A1	0.350	0.360	8.89	9.14
B	0.310	0.320	7.87	8.13
C	0.070	0.080	1.78	2.03
D	0.025	0.031	0.63	0.79
E	0.010	BSC	0.25	BSC
G	0.067	BSC	1.70	BSC
H	0.410	0.420	10.41	10.67
K	0.030	0.050	0.76	1.27
L	0.001	0.005	0.03	0.13
M	0.035	0.045	0.89	1.14
N	0.010	BSC	0.25	BSC
P	0.031	0.041	0.79	1.04
R	0°	6°	0°	6°
U	0.220	BSC	5.58	BSC
V	0.296	BSC	7.52	BSC

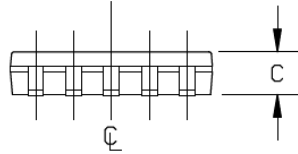

- NOTE:
1. DIMENSION DOES NOT INCLUDE MOLD FLASH OR PROTRUSIONS.
 2. DIMENSION INCLUDES PLATING THICKNESS. SOLDER MASK OPENING
 3. RED CIRCLES IN LAND PATTERN REPRESENT THERMAL VIA, 0.30MM IN DIAMETER & SHOULD BE CONNECTED TO GND FOR MAXIMUM PERFORMANCE
 4. GREEN RECTANGLES IN LAND PATTERN REPRESENT SOLDER STENCIL OPENING (OPTIONAL), 1.50X1.50MM.

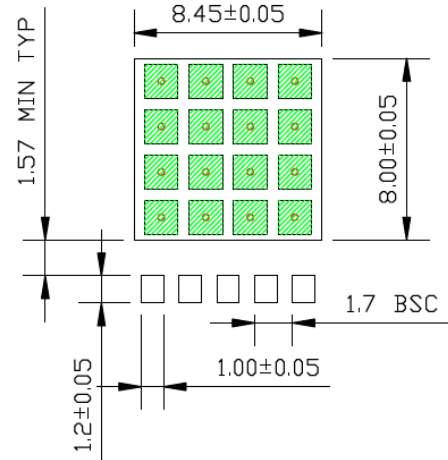

RECOMMENDED
LAND PATTERN

Note: For the most current package drawings, please see the Microchip Packaging Specification located at <http://www.microchip.com/packaging>.

MIC37300/01/02/03

8-Lead 3 mm x 3 mm DFN (ML) Package Outline and Recommended Land Pattern

TITLE

8 LEAD DFN 3x3mm PACKAGE OUTLINE & RECOMMENDED LAND PATTERN

DRAWING #	DFN33-8LD-PL-1	UNIT	MM
-----------	----------------	------	----

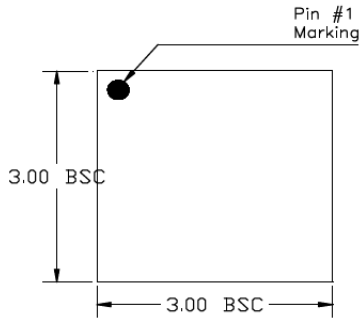

TOP VIEW

NOTE: 1, 2, 3

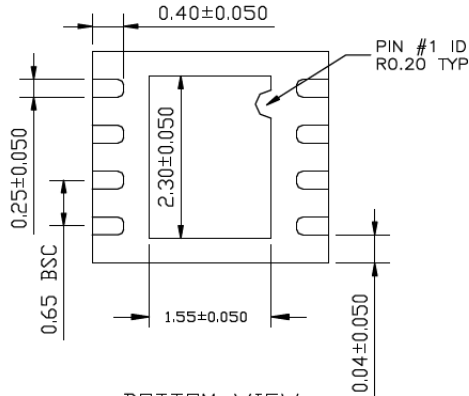

BOTTOM VIEW

NOTE: 1, 2, 3

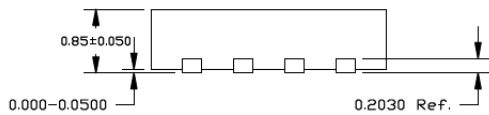

SIDE VIEW

NOTE: 1, 2, 3

NOTE:

1. MAX PACKAGE WARPAGE IS 0.05 MM
2. MAX ALLOWABLE BURR IS 0.076MM IN ALL DIRECTIONS
3. PIN #1 IS ON TOP WILL BE LASER MARKED
4. RED CIRCLE IN LAND PATTERN INDICATE THERMAL VIA. SIZE SHOULD BE 0.30-0.35 MM IN DIAMETER AND SHOULD BE CONNECTED TO GND FOR MAX THERMAL PERFORMANCE
5. GREEN RECTANGLES (SHADED AREA) INDICATE SOLDER STENCIL OPENING ON EXPOSED PAD AREA. SIZE SHOULD BE 0.50x0.90 MM IN SIZE, 0.20 MM SPACING.

Note: For the most current package drawings, please see the Microchip Packaging Specification located at <http://www.microchip.com/packaging>.

8-Lead 3 mm x 3 mm DFN (ML) Package Outline and Recommended Land Pattern

POD-Land Pattern drawing #DFN33-8LD-PL-1

RECOMMENDED LAND PATTERN

NOTE: 4, 5

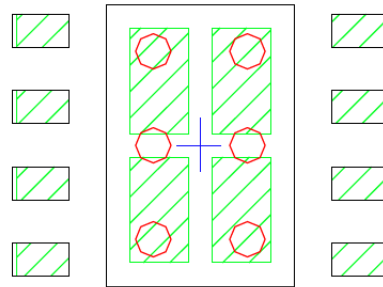

STACKED-UP

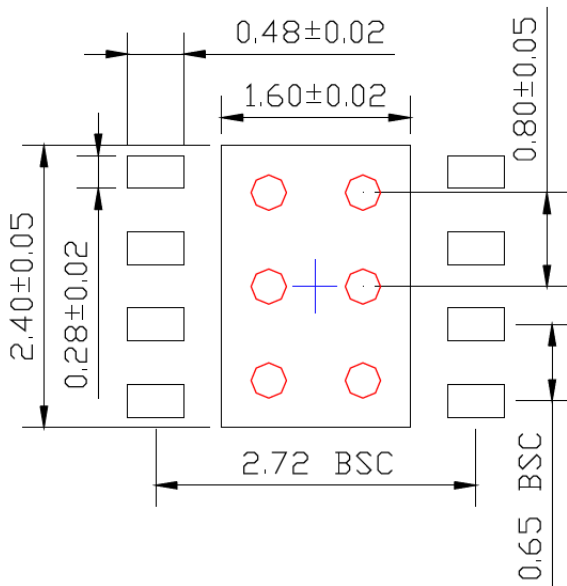

EXPOSED METAL TRACE

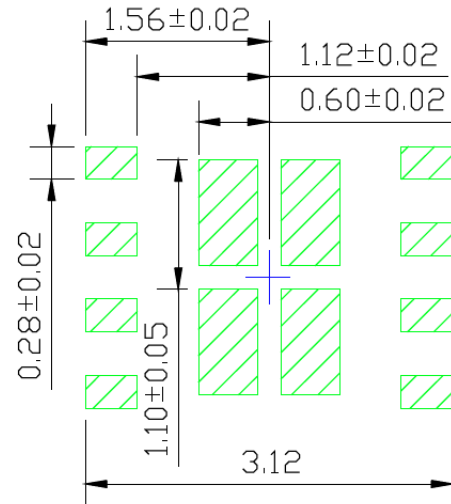

SOLDER STENCIL OPENING

Note: For the most current package drawings, please see the Microchip Packaging Specification located at <http://www.microchip.com/packaging>.

NOTES:

APPENDIX A: REVISION HISTORY

Revision A (March 2019)

- Converted Micrel document MIC37300/01/02/03 to Microchip data sheet DS20006169A.
- Minor text changes throughout.

NOTES:

PRODUCT IDENTIFICATION SYSTEM

To order or obtain information, e.g., on pricing or delivery, contact your local Microchip representative or sales office.

PART NO.	-X.X	X	XX	-XX
Device	Output Voltage	Junction Temperature Range	Package	Media Type
Device:	MIC373xx: 3.0A Low-Voltage μ Cap LDO Regulator MIC37300: Fixed V_{OUT} to 3.3V in S-PAK (3-Pin) Package MIC37301: Fixed V_{OUT} to 3.3V in S-PAK (5-Pin) 8-Pin SOIC (ePad) Package MIC37302: Adjustable V_{OUT} to 1.24V in S-PAK Package (5-Pin) MIC37303: Adjustable V_{OUT} to 1.24V in 8-Pin ePad SOIC and DFN Packages			
Output Voltage:	Fixed Output Voltage Option (MIC37300/37301) 1.5 = 1.5V 1.65 = 1.65V 1.8 = 1.8V 2.5 = 2.5V 3.3 = 3.3V Adjustable Output Voltage Option (MIC37302, MIC37303) <blank> = Adjustable			
Junction Temperature Range:	W = -40°C to +125°C, RoHs Compliant* Y = -40°C to +125°C, RoHs Compliant			
Package:	R = S-PAK-3, S-PAK-5 (MIC37300, MIC37301 and MIC37302) M = SOIC-8 (ePad), DFN (MIC37301/37303) U = TO-263-5 (MIC37302)			
Media Type:	<blank> = 48/Tube (R, S-PAK) <blank> = 50/Tube (U, TO-263-5) <blank> = 95/Tube (M, SOIC-8, DFN) T5 = 500/Reel (M, DFN) TR = 750/Reel (R, U, S-PAK, TO-263-5) TR = 2,500/Reel (M, SOIC-8 (ePad), DFN)			
*RoHS-compliant with 'high-melting solder' exemption.				

Examples:

- a) MIC37300-1.5WR: 3.0A Low-Voltage μ Cap LDO Regulator, 1.5 Fixed Output Voltage option, -40°C to +125°C Junction Temperature Range, RoHs Compliant, 3-Lead S-PAK, 48/Tube
- b) MIC37300-1.8WR-TR: 3.0A Low-Voltage μ Cap LDO Regulator, 1.5 Fixed Output Voltage option, -40°C to +125°C Junction Temperature Range, RoHs Compliant, 3-Lead S-PAK, 750/Reel
- c) MIC37301-1.65YM: 3.0A Low-Voltage μ Cap LDO Regulator, 1.65 Fixed Output Voltage option, -40°C to +125°C Junction Temperature Range, RoHs Compliant, SOIC-8, 95/Tube
- d) MIC37301-1.65YM-TR: 3.0A Low-Voltage μ Cap LDO Regulator, 1.65 Fixed Output Voltage option, -40°C to +125°C Junction Temperature Range, RoHs Compliant, DFN, 2,500/Reel
- e) MIC37302WU: 3.0A Low-Voltage μ Cap LDO Regulator, ADJ. Output Voltage option, -40°C to +125°C Junction Temperature Range, RoHs Compliant, TO-263-5, 50/Tube
- f) MIC37302WU-TR: 3.0A Low-Voltage μ Cap LDO Regulator, ADJ. Output Voltage option, -40°C to +125°C Junction Temperature Range, RoHs Compliant, TO-263-5, 750/Reel
- g) MIC37303YM: 3.0A Low-Voltage μ Cap LDO Regulator, ADJ. Output Voltage option, -40°C to +125°C Junction Temperature Range, RoHs Compliant, SOIC-8, 95/Tube
- h) MIC37303YM-T5: 3.0A Low-Voltage μ Cap LDO Regulator, ADJ. Output Voltage option, -40°C to +125°C Junction Temperature Range, RoHs Compliant, DFN, 500/Reel
- h) MIC37303YM-TR: 3.0A Low-Voltage μ Cap LDO Regulator, ADJ. Output Voltage option, -40°C to +125°C Junction Temperature Range, RoHs Compliant, SOIC-8, 2, 500/Reel

Note 1: Tape and Reel identifier only appears in the catalog part number description. This identifier is used for ordering purposes and is not printed on the device package. Check with your Microchip Sales Office for package availability with the Tape and Reel option.

NOTES:

Note the following details of the code protection feature on Microchip devices:

- Microchip products meet the specification contained in their particular Microchip Data Sheet.
- Microchip believes that its family of products is one of the most secure families of its kind on the market today, when used in the intended manner and under normal conditions.
- There are dishonest and possibly illegal methods used to breach the code protection feature. All of these methods, to our knowledge, require using the Microchip products in a manner outside the operating specifications contained in Microchip's Data Sheets. Most likely, the person doing so is engaged in theft of intellectual property.
- Microchip is willing to work with the customer who is concerned about the integrity of their code.
- Neither Microchip nor any other semiconductor manufacturer can guarantee the security of their code. Code protection does not mean that we are guaranteeing the product as “unbreakable.”

Code protection is constantly evolving. We at Microchip are committed to continuously improving the code protection features of our products. Attempts to break Microchip's code protection feature may be a violation of the Digital Millennium Copyright Act. If such acts allow unauthorized access to your software or other copyrighted work, you may have a right to sue for relief under that Act.

Information contained in this publication regarding device applications and the like is provided only for your convenience and may be superseded by updates. It is your responsibility to ensure that your application meets with your specifications. MICROCHIP MAKES NO REPRESENTATIONS OR WARRANTIES OF ANY KIND WHETHER EXPRESS OR IMPLIED, WRITTEN OR ORAL, STATUTORY OR OTHERWISE, RELATED TO THE INFORMATION, INCLUDING BUT NOT LIMITED TO ITS CONDITION, QUALITY, PERFORMANCE, MERCHANTABILITY OR FITNESS FOR PURPOSE. Microchip disclaims all liability arising from this information and its use. Use of Microchip devices in life support and/or safety applications is entirely at the buyer's risk, and the buyer agrees to defend, indemnify and hold harmless Microchip from any and all damages, claims, suits, or expenses resulting from such use. No licenses are conveyed, implicitly or otherwise, under any Microchip intellectual property rights unless otherwise stated.

Microchip received ISO/TS-16949:2009 certification for its worldwide headquarters, design and wafer fabrication facilities in Chandler and Tempe, Arizona; Gresham, Oregon and design centers in California and India. The Company's quality system processes and procedures are for its PIC® MCUs and dsPIC® DSCs, KEELoq® code hopping devices, Serial EEPROMs, microperipherals, nonvolatile memory and analog products. In addition, Microchip's quality system for the design and manufacture of development systems is ISO 9001:2000 certified.

**QUALITY MANAGEMENT SYSTEM
CERTIFIED BY DNV
= ISO/TS 16949 =**

Trademarks

The Microchip name and logo, the Microchip logo, AnyRate, AVR, AVR logo, AVR Freaks, BitCloud, chipKIT, chipKIT logo, CryptoMemory, CryptoRF, dsPIC, FlashFlex, flexPWR, Heldo, JukeBlox, KeeLoq, Kleer, LANCheck, LINK MD, maXStylus, maXTouch, MediaLB, megaAVR, MOST, MOST logo, MPLAB, OptoLyzer, PIC, picoPower, PICSTART, PIC32 logo, Prochip Designer, QTouch, SAM-BA, SpyNIC, SST, SST Logo, SuperFlash, tinyAVR, UNI/O, and XMEGA are registered trademarks of Microchip Technology Incorporated in the U.S.A. and other countries.

ClockWorks, The Embedded Control Solutions Company, EtherSynch, Hyper Speed Control, HyperLight Load, IntellIMOS, mTouch, Precision Edge, and Quiet-Wire are registered trademarks of Microchip Technology Incorporated in the U.S.A.

Adjacent Key Suppression, AKS, Analog-for-the-Digital Age, Any Capacitor, AnyIn, AnyOut, BodyCom, CodeGuard, CryptoAuthentication, CryptoAutomotive, CryptoCompanion, CryptoController, dsPICDEM, dsPICDEM.net, Dynamic Average Matching, DAM, ECAN, EtherGREEN, In-Circuit Serial Programming, ICSP, INICnet, Inter-Chip Connectivity, JitterBlocker, KleerNet, KleerNet logo, memBrain, Mindi, MiWi, motorBench, MPASM, MPF, MPLAB Certified logo, MPLIB, MPLINK, MultiTRAK, NetDetach, Omniscient Code Generation, PICDEM, PICDEM.net, PICKit, PICtail, PowerSmart, PureSilicon, QMatrix, REAL ICE, Ripple Blocker, SAM-ICE, Serial Quad I/O, SMART-I.S., SQI, SuperSwitcher, SuperSwitcher II, Total Endurance, TSHARC, USBCheck, VariSense, ViewSpan, WiperLock, Wireless DNA, and ZENA are trademarks of Microchip Technology Incorporated in the U.S.A. and other countries.

SQTP is a service mark of Microchip Technology Incorporated in the U.S.A.

Silicon Storage Technology is a registered trademark of Microchip Technology Inc. in other countries.

GestIC is a registered trademark of Microchip Technology Germany II GmbH & Co. KG, a subsidiary of Microchip Technology Inc., in other countries.

All other trademarks mentioned herein are property of their respective companies.

© 2018, Microchip Technology Incorporated, All Rights Reserved.
ISBN: 978-1-5224-4242-4



MICROCHIP

Worldwide Sales and Service

AMERICAS

Corporate Office
2355 West Chandler Blvd.
Chandler, AZ 85224-6199
Tel: 480-792-7200
Fax: 480-792-7277
Technical Support:
<http://www.microchip.com/support>
Web Address:
www.microchip.com

Atlanta

Duluth, GA
Tel: 678-957-9614
Fax: 678-957-1455

Austin, TX

Tel: 512-257-3370

Boston

Westborough, MA
Tel: 774-760-0087
Fax: 774-760-0088

Chicago

Itasca, IL
Tel: 630-285-0071
Fax: 630-285-0075

Dallas

Addison, TX
Tel: 972-818-7423
Fax: 972-818-2924

Detroit

Novi, MI
Tel: 248-848-4000

Houston, TX

Tel: 281-894-5983

Indianapolis

Noblesville, IN
Tel: 317-773-8323
Fax: 317-773-5453
Tel: 317-536-2380

Los Angeles

Mission Viejo, CA
Tel: 949-462-9523
Fax: 949-462-9608
Tel: 951-273-7800

Raleigh, NC

Tel: 919-844-7510

New York, NY

Tel: 631-435-6000

San Jose, CA

Tel: 408-735-9110
Tel: 408-436-4270

Canada - Toronto

Tel: 905-695-1980
Fax: 905-695-2078

ASIA/PACIFIC

Australia - Sydney
Tel: 61-2-9868-6733

China - Beijing
Tel: 86-10-8569-7000

China - Chengdu
Tel: 86-28-8665-5511

China - Chongqing
Tel: 86-23-8980-9588

China - Dongguan
Tel: 86-769-8702-9880

China - Guangzhou
Tel: 86-20-8755-8029

China - Hangzhou
Tel: 86-571-8792-8115

China - Hong Kong SAR
Tel: 852-2943-5100

China - Nanjing
Tel: 86-25-8473-2460

China - Qingdao
Tel: 86-532-8502-7355

China - Shanghai
Tel: 86-21-3326-8000

China - Shenyang
Tel: 86-24-2334-2829

China - Shenzhen
Tel: 86-755-8864-2200

China - Suzhou
Tel: 86-186-6233-1526

China - Wuhan
Tel: 86-27-5980-5300

China - Xian
Tel: 86-29-8833-7252

China - Xiamen
Tel: 86-592-2388138

China - Zhuhai
Tel: 86-756-3210040

ASIA/PACIFIC

India - Bangalore
Tel: 91-80-3090-4444

India - New Delhi
Tel: 91-11-4160-8631

India - Pune
Tel: 91-20-4121-0141

Japan - Osaka
Tel: 81-6-6152-7160

Japan - Tokyo
Tel: 81-3-6880-3770

Korea - Daegu
Tel: 82-53-744-4301

Korea - Seoul
Tel: 82-2-554-7200

Malaysia - Kuala Lumpur
Tel: 60-3-7651-7906

Malaysia - Penang
Tel: 60-4-227-8870

Philippines - Manila
Tel: 63-2-634-9065

Singapore
Tel: 65-6334-8870

Taiwan - Hsin Chu
Tel: 886-3-577-8366

Taiwan - Kaohsiung
Tel: 886-7-213-7830

Taiwan - Taipei
Tel: 886-2-2508-8600

Thailand - Bangkok
Tel: 66-2-694-1351

Vietnam - Ho Chi Minh
Tel: 84-28-5448-2100

EUROPE

Austria - Wels
Tel: 43-7242-2244-39
Fax: 43-7242-2244-393

Denmark - Copenhagen
Tel: 45-4450-2828
Fax: 45-4485-2829

Finland - Espoo
Tel: 358-9-4520-820

France - Paris
Tel: 33-1-69-53-63-20
Fax: 33-1-69-30-90-79

Germany - Garching
Tel: 49-8931-9700

Germany - Haan
Tel: 49-2129-3766400

Germany - Heilbronn
Tel: 49-7131-67-3636

Germany - Karlsruhe
Tel: 49-721-625370

Germany - Munich
Tel: 49-89-627-144-0
Fax: 49-89-627-144-44

Germany - Rosenheim
Tel: 49-8031-354-560

Israel - Ra'anana
Tel: 972-9-744-7705

Italy - Milan
Tel: 39-0331-742611
Fax: 39-0331-466781

Italy - Padova
Tel: 39-049-7625286

Netherlands - Drunen
Tel: 31-416-690399
Fax: 31-416-690340

Norway - Trondheim
Tel: 47-7288-4388

Poland - Warsaw
Tel: 48-22-3325737

Romania - Bucharest
Tel: 40-21-407-87-50

Spain - Madrid
Tel: 34-91-708-08-90
Fax: 34-91-708-08-91

Sweden - Gothenberg
Tel: 46-31-704-60-40

Sweden - Stockholm
Tel: 46-8-5090-4654

UK - Wokingham
Tel: 44-118-921-5800
Fax: 44-118-921-5820