

High-Accuracy, High-Side, Fixed Current-Limit Power Switch

Features

- $\pm 5\%$ Current-Limit Accuracy
- Input Supply Range from 2.5V to 5.5V
- Low Quiescent Current: 100 μ A Typical (Switch ON)
- 75 m Ω Typical $R_{DS(ON)}$ at 5V
- Current-Limit Options: 0.5A, 0.8A, 1A, and 1.2A
- Soft-Start Control via an External Capacitor
- Undervoltage Lockout (UVLO)
- Fast Response Time (10 μ s) to Short-Circuit Loads
- Fault Status Output Flag
- Logic Controlled Enable (Active-High, Active-Low)
- Thermal Shutdown
- Pin Compatible with MIC2005
- 6-Pin 2 mm x 2 mm Thin DFN and 6-Pin SOT-23 Packages
- Junction Temperature Range from -40°C to $+125^{\circ}\text{C}$

Applications

- USB Peripherals and USB 2.0/3.0-Compatible
- DTV/STB
- Notebooks and Consumer Electronics
- General Purpose Power Distribution

General Description

The MIC2033 is a high-side MOSFET power distribution switch that provides increased system reliability, utilizing 5% current-limit accuracy.

The MIC2033 has an operating input voltage range from 2.5V to 5.5V, is internally current-limited and has thermal shutdown to protect the device and system. The MIC2033 is offered with either active-high or active-low logic level enable input controls, has an open-drain fault status output flag with a built-in 32 ms delay that asserts low during over current or thermal shutdown conditions.

The MIC2033 is available in several different fixed current-limit options: 0.5A, 0.8A, 1A, and 1.2A. A capacitor-adjustable soft-start circuit minimizes inrush current in applications where high capacitive loads are used.

The MIC2033 is offered in both 6-pin SOT-23 and 6-pin 2 mm x 2 mm thin DFN packages. The MIC2033 has an operating junction temperature range of -40°C to $+125^{\circ}\text{C}$.

Package Types

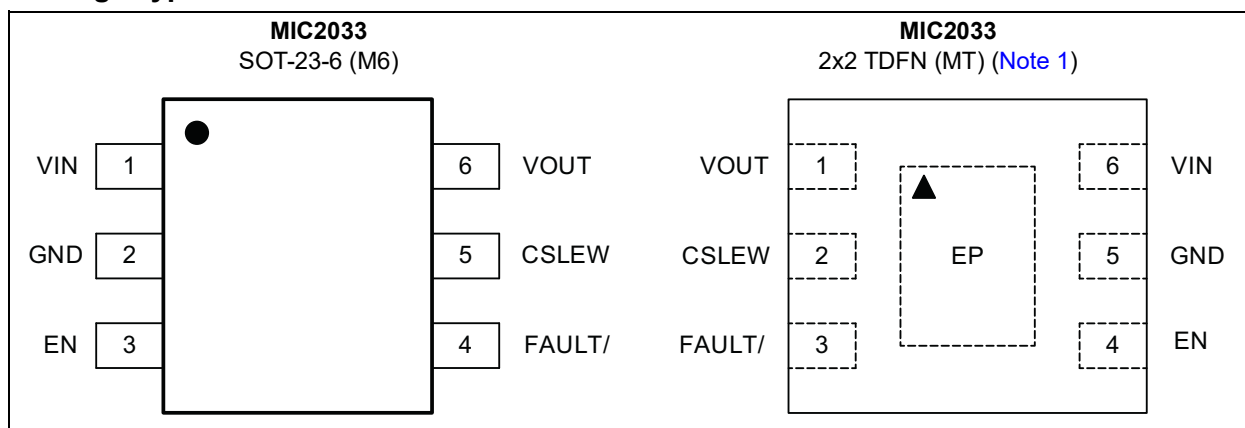

Note 1: Thin DFN \blacktriangle = Pin 1 identifier.

MIC2033

Typical Application Circuit

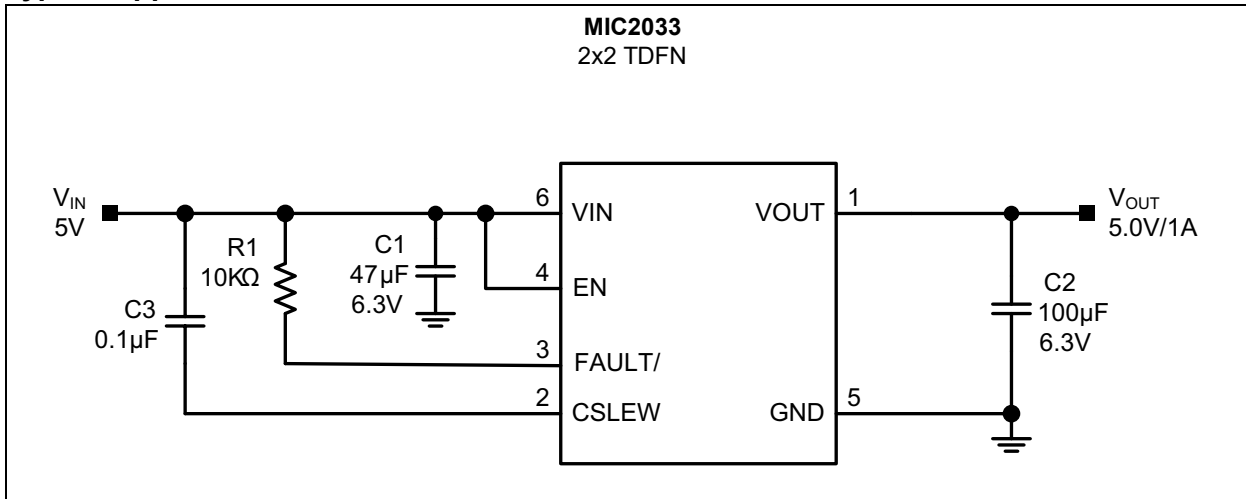

Functional Block Diagram

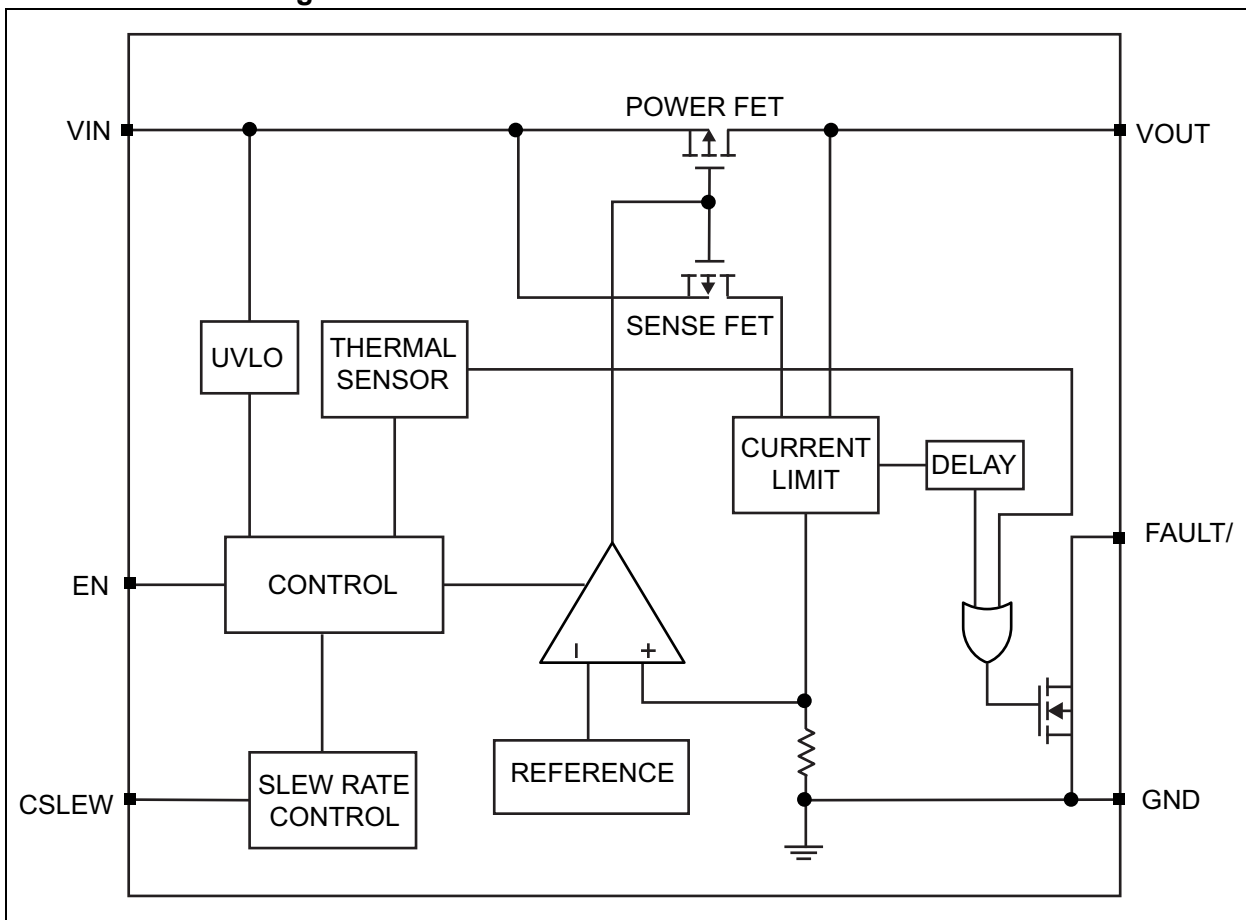

1.0 ELECTRICAL CHARACTERISTICS

Absolute Maximum Ratings †

V_{IN} to GND	-0.3V to +6V
V_{OUT} to GND	-0.3V to V_{IN}
V_{CSLEW} to GND	-0.3V to $V_{IN} + 0.3V$
V_{EN} to GND	-0.3V to +6V
V_{FAULT} to GND	-0.3V to $V_{IN} + 0.3V$
FAULT/ Current (I_{FAULT})	25 mA
Maximum Power Dissipation (P_D)	Internally Limited
ESD Rating (HBM) (Note 1)	3 kV
ESD Rating (MM) (Note 1)	300V

Operating Ratings ‡

Supply Voltage (V_{IN})	+2.5V to +5.5V
V_{EN}	-0.3V to +5.5V
V_{CSLEW} , V_{OUT}	-0.3V to V_{IN}

† **Notice:** Stresses above those listed under “Absolute Maximum Ratings” may cause permanent damage to the device. This is a stress rating only and functional operation of the device at those or any other conditions above those indicated in the operational sections of this specification is not intended. Exposure to maximum rating conditions for extended periods may affect device reliability.

‡ **Notice:** The device is not guaranteed to function outside its operating ratings.

Note 1: Devices are ESD sensitive. Handling precautions are recommended. Human body model, 1.5 k Ω in series with 100 pF.

MIC2033

ELECTRICAL CHARACTERISTICS

Electrical Characteristics: $V_{IN} = V_{EN} = 5V$, $C_{IN} = 1 \mu F$, $C_{CSLEW} = OPEN$, $C_{OUT} = 1 \mu F$; $T_J = +25^\circ C$, unless noted. **Bold values indicate $-40^\circ C \leq T_J \leq +125^\circ C$. (Note 1).**

Symbol	Parameters	Min.	Typ.	Max.	Units	Conditions
Power Supply Input						
V_{IN}	Input Voltage Range	2.5	—	5.5	V	—
V_{UVLO}	Input Supply Undervoltage Lockout Threshold	2.0	2.25	2.5	V	V_{IN} rising
		1.9	2.15	2.4		V_{IN} falling
$V_{UVLOHYS}$	Input Supply Undervoltage Lockout Threshold Hysteresis	—	100	—	mV	V_{IN} rising or V_{IN} falling
I_{DD}	Supply Current	—	0.75	5	μA	Switch OFF; Active-High Enable (A): $V_{EN} = 0V$, $V_{IN} = 5V$, $I_{OUT} = 0A$
						Switch OFF; Active-Low Enable (B): $V_{EN} = V_{IN} = 5V$, $I_{OUT} = 0A$
		—	100	300	μA	Switch ON; Active-High Enable (A): $V_{EN} = 1.5V$, $V_{IN} = 5V$, $I_{OUT} = 0A$
						Switch ON; Active-Low Enable (B): $V_{EN} = 0V$, $V_{IN} = 5V$, $I_{OUT} = 0A$
Power MOSFET						
$R_{DS(ON)}$	Switch On-Resistance	—	100	177	m Ω	$V_{IN} = 2.5V$, $I_{OUT} = 350 mA$
		—	85	145		$V_{IN} = 3.3V$, $I_{OUT} = 350 mA$
		—	75	125		$V_{IN} = 5V$, $I_{OUT} = 350 mA$
I_{LKG}	Output Leakage Current	—	0.22	15	μA	Switch OFF, $V_{OUT} = 0V$
Current-Limit						
I_{LIMIT}	Current-Limit Accuracy	0.475	0.5	0.525	A	MIC2033-05xxxx, $V_{OUT} = 0.8 \cdot V_{IN}$
		0.76	0.8	0.84		MIC2033-08xxxx, $V_{OUT} = 0.8 \cdot V_{IN}$
		0.95	1.0	1.05		MIC2033-10xxxx, $V_{OUT} = 0.8 \cdot V_{IN}$
		1.14	1.2	1.26		MIC2033-12xxxx, $V_{OUT} = 0.8 \cdot V_{IN}$
I/O						
V_{EN}	Enable Voltage	—	—	0.5	V	Logic-Low
		1.5	—	—		Logic-High
I_{EN}	Enable Input Current	—	1	—	μA	$0V \leq V_{EN} \leq 5V$
R_{FLAG}	Fault Flag Output Resistance	—	—	25	Ω	$I_{OUT} = 10 mA$

Note 1: Specification for packaged product only.

2: See [Timing Diagrams](#).

3: C_{CSLEW} values above $0.1 \mu F$ are not recommended.

4: For dynamic current loads faster than typically 30 mA/ms. Slower current loads will delay the deactivation of V_{OUT} and the current limitation, allowing FAULT/ to be asserted before these.

ELECTRICAL CHARACTERISTICS (CONTINUED)

Electrical Characteristics: $V_{IN} = V_{EN} = 5V$, $C_{IN} = 1 \mu F$, $C_{CSLEW} = OPEN$, $C_{OUT} = 1 \mu F$; $T_J = +25^\circ C$, unless noted. **Bold** values indicate $-40^\circ C \leq T_J \leq +125^\circ C$. (**Note 1**).

Symbol	Parameters	Min.	Typ.	Max.	Units	Conditions
I_{FLAG_OFF}	Fault Flag Off Current	—	—	10	μA	$V_{FLAG} = V_{IN}$
$R_{FAULT/}$	FAULT/ Output Resistance	—	—	25	Ω	$I_{OUT} = 10 \text{ mA}$
$I_{FAULT/_OFF}$	FAULT/ Off Current	—	—	10	μA	$V_{FAULT/} = V_{IN}$
I_{CSLEW}	CSLEW Input Current (Note 2)	—	0.6	—	μA	$V_{CSLEW} = V_{IN}$
Thermal Protection						
T_{TSD}	Thermal Shutdown Temperature	—	157	—	$^\circ C$	T_J rising
T_{TSDHYS}	Thermal Shutdown Hysteresis	—	15	—	$^\circ C$	—
Timing Specifications (AC Parameters)						
t_{RISE}	Output Turn-on Rise Time (Note 2)	—	700	—	μs	$R_{LOAD} = 10\Omega$; $C_{OUT} = 1 \mu F$
t_{FALL}	Output Turn-off Fall Time (Note 2)	—	32	—	μs	$V_{EN} = OFF$; $R_{LOAD} = 10\Omega$; $C_{OUT} = 1 \mu F$
t_{ON_DLY}	Output Turn-on Delay (Note 2)	—	700	—	μs	$R_{LOAD} = 10\Omega$; $C_{OUT} = 1 \mu F$
t_{OFF_DLY}	Output Turn-off Delay (Note 2)	—	5	—	μs	$R_{LOAD} = 10\Omega$; $C_{OUT} = 1 \mu F$
t_{SC_RESP}	Short Circuit Response Time (Note 2, Note 3)	—	10	—	ms	$V_{OUT} = 0V$ (short-circuit); $C_{CSLEW} = 0.1 \mu F$
t_{SC_RESP}	Short Circuit Response Time (Note 2)	—	10	—	μs	$V_{OUT} = 0V$ (short-circuit); $C_{CSLEW} = OPEN$
$t_{FAULT/}$	Overcurrent Fault Response Delay Time (Note 2, Note 4)	16	32	49	ms	—

Note 1: Specification for packaged product only.

2: See [Timing Diagrams](#).

3: C_{CSLEW} values above $0.1 \mu F$ are not recommended.

4: For dynamic current loads faster than typically 30 mA/ms. Slower current loads will delay the deactivation of V_{OUT} and the current limitation, allowing FAULT/ to be asserted before these.

MIC2033

TEMPERATURE SPECIFICATIONS

Parameters	Sym.	Min.	Typ.	Max.	Units	Conditions
Temperature Ranges						
Junction Operating Temperature Range	T_J	-40	—	+125	°C	Note 1
Storage Temperature Range	T_S	-65	—	+150	°C	—
Lead Temperature	—	—	—	+260	°C	Soldering, 10s
Package Thermal Resistances						
Thermal Resistance SOT-23-6	θ_{JA}	—	177.2	—	°C/W	—
Thermal Resistance 6-pin 2 mm x 2 mm DFN	θ_{JA}	—	90	—	°C/W	—

Note 1: The maximum allowable power dissipation is a function of ambient temperature, the maximum allowable junction temperature and the thermal resistance from junction to air (i.e., T_A , T_J , θ_{JA}). Exceeding the maximum allowable power dissipation will cause the device operating junction temperature to exceed the maximum +125°C rating. Sustained junction temperatures above +125°C can impact the device reliability.

2.0 TYPICAL PERFORMANCE CURVES

Note: The graphs and tables provided following this note are a statistical summary based on a limited number of samples and are provided for informational purposes only. The performance characteristics listed herein are not tested or guaranteed. In some graphs or tables, the data presented may be outside the specified operating range (e.g., outside specified power supply range) and therefore outside the warranted range.

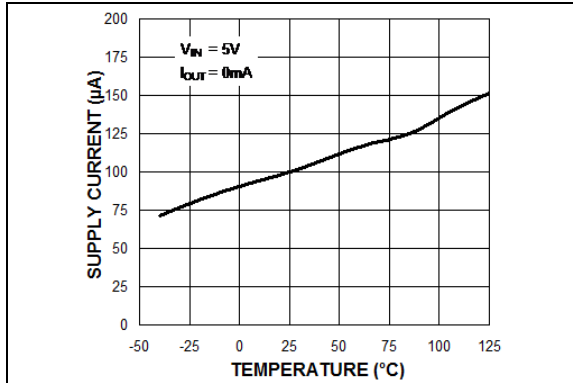

FIGURE 2-1: Input Supply Current vs. Temperature.

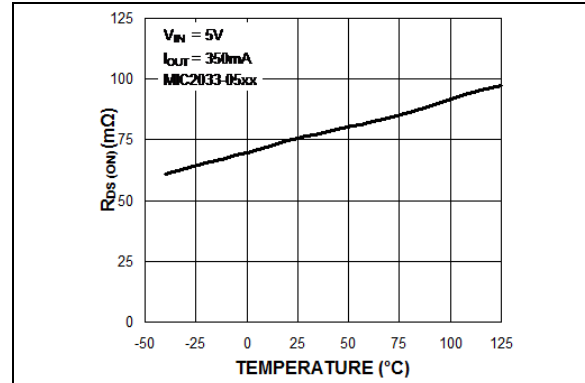

FIGURE 2-4: $R_{DS(ON)}$ vs. Temperature.

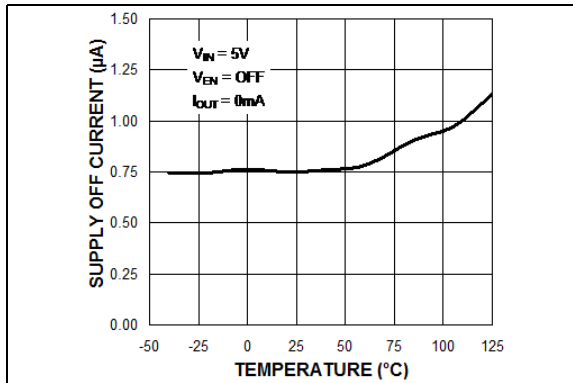

FIGURE 2-2: V_{IN} OFF Current vs. Temperature.

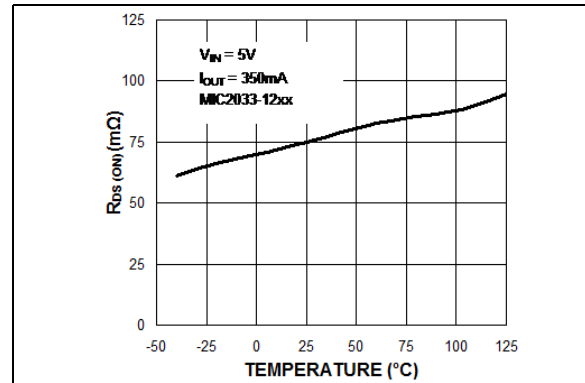

FIGURE 2-5: $R_{DS(ON)}$ vs. Temperature.

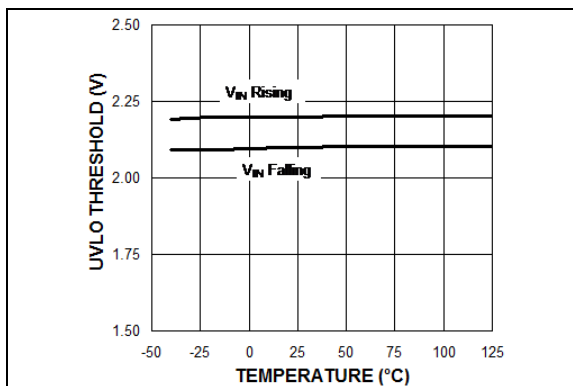

FIGURE 2-3: Undervoltage Lockout vs. Temperature.

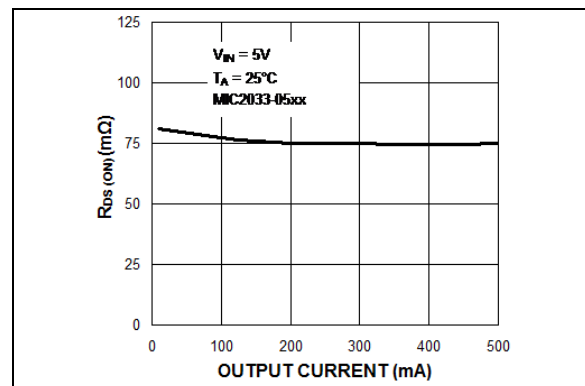

FIGURE 2-6: $R_{DS(ON)}$ vs. Output Current.

MIC2033

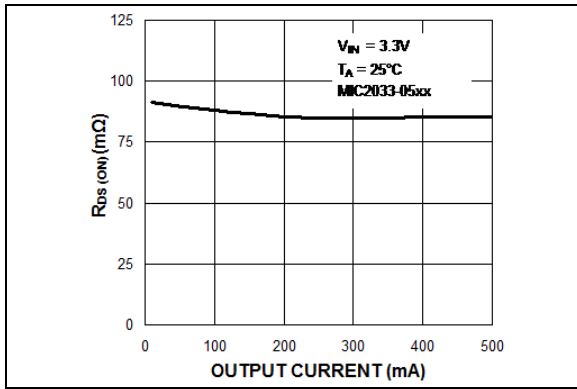

FIGURE 2-7: $R_{DS(ON)}$ vs. Output Current.

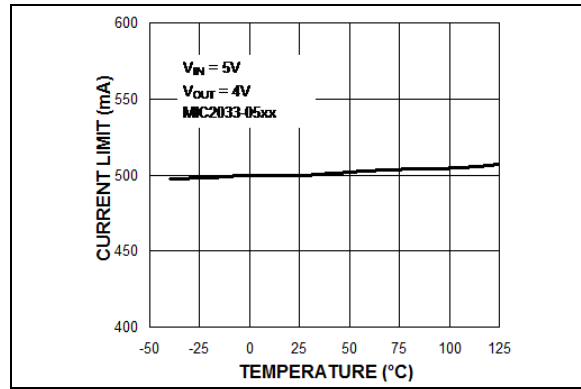

FIGURE 2-10: Current Limit vs. Temperature.

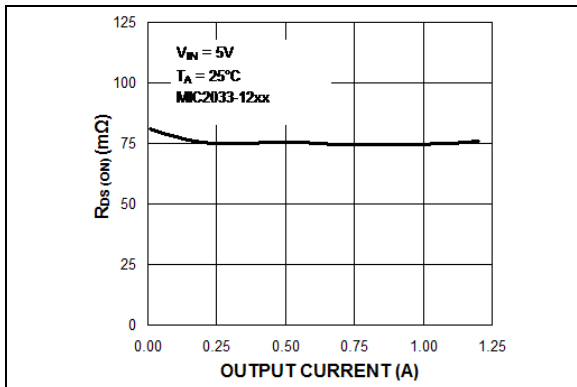

FIGURE 2-8: $R_{DS(ON)}$ vs. Output Current.

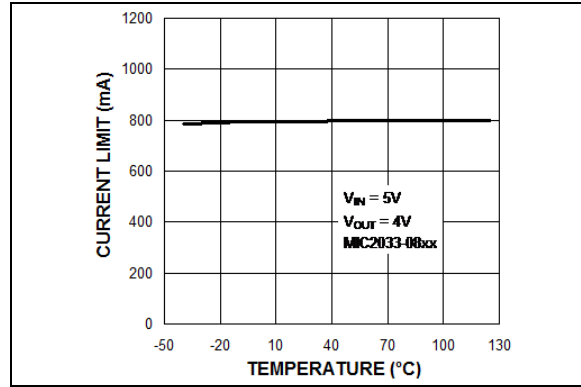

FIGURE 2-11: Current Limit vs. Temperature.

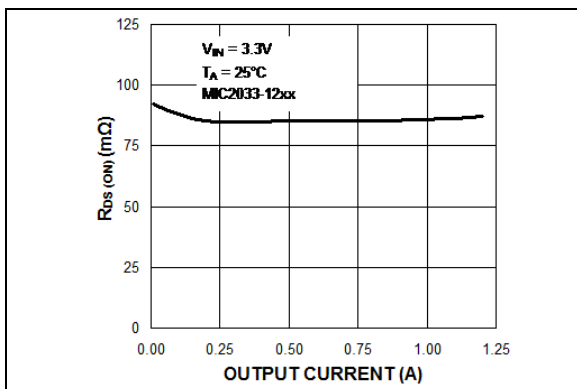

FIGURE 2-9: $R_{DS(ON)}$ vs. Output Current.

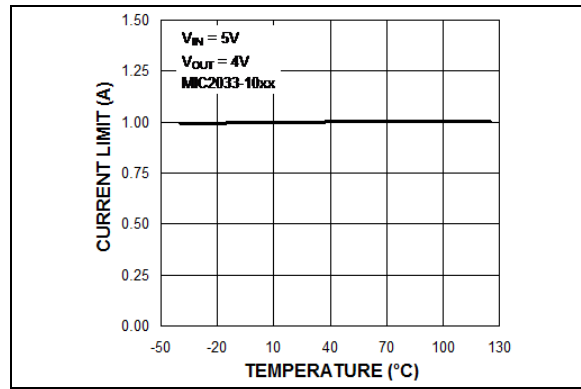

FIGURE 2-12: Current Limit vs. Temperature.

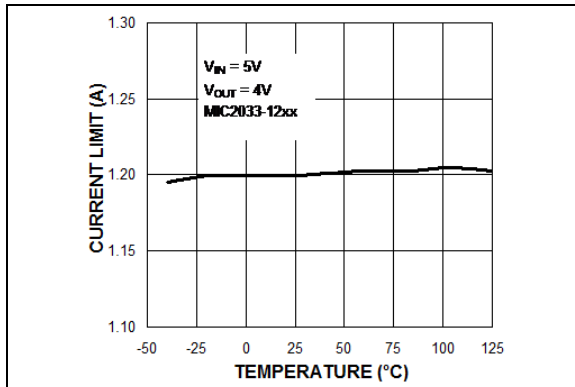

FIGURE 2-13: Current Limit vs. Temperature.

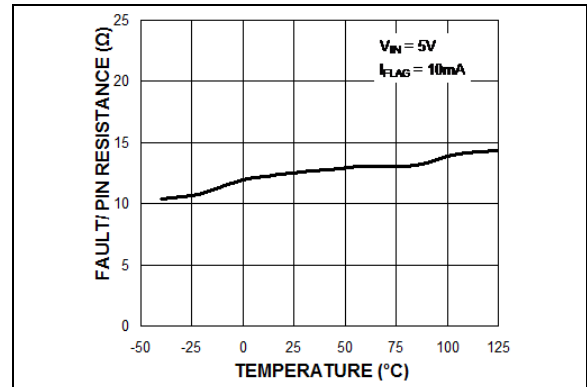

FIGURE 2-16: FAULT/ Pin Resistance vs. Temperature.

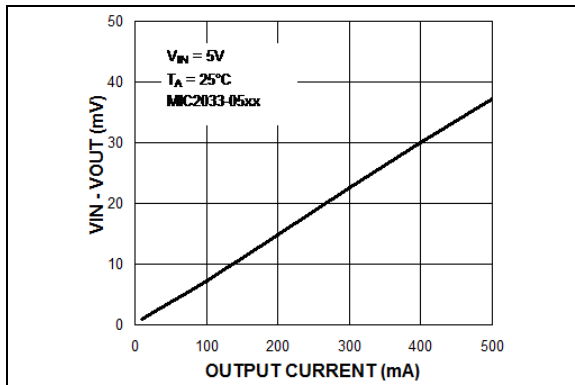

FIGURE 2-14: $V_{IN} - V_{OUT}$ vs. Output Current.

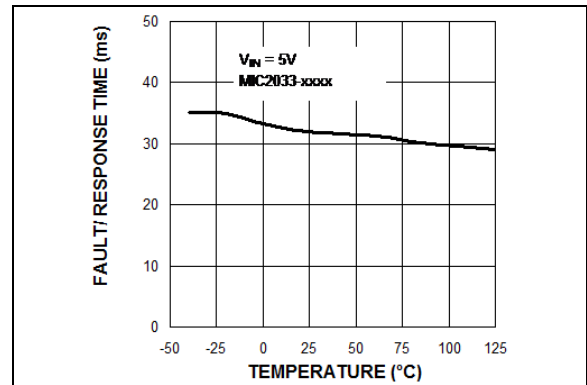

FIGURE 2-17: FAULT/ Response Time vs. Temperature.

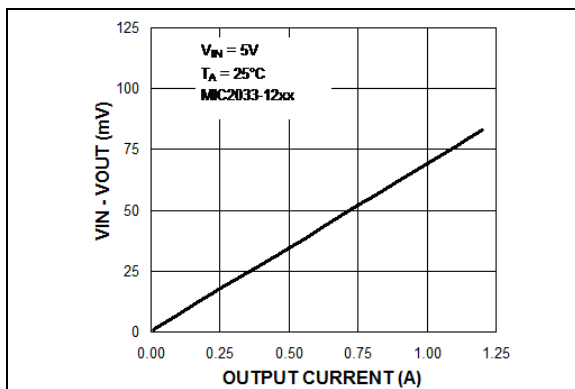

FIGURE 2-15: $V_{IN} - V_{OUT}$ vs. Output Current.

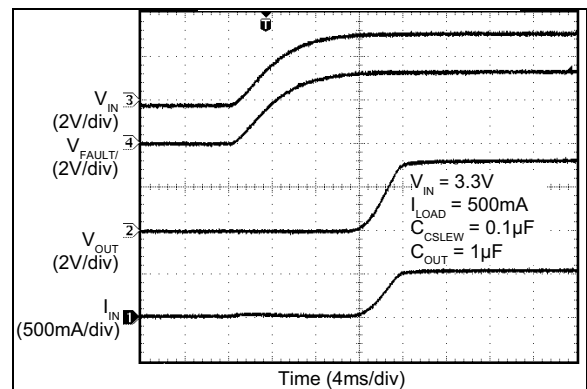

FIGURE 2-18: Soft-Start Turn-On.

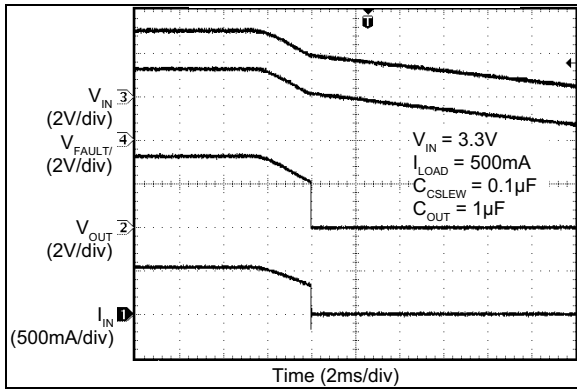

FIGURE 2-19: Soft-Start Turn-Off.

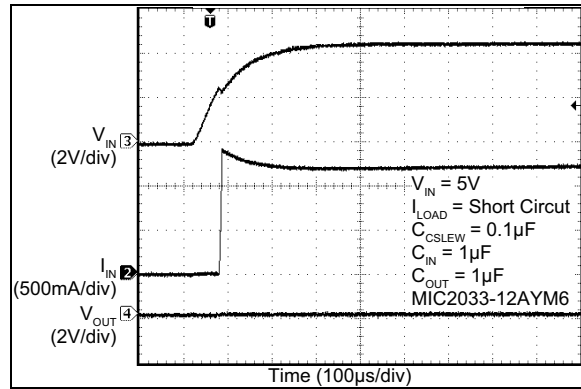

FIGURE 2-22: Turn-On into Short-Circuit.

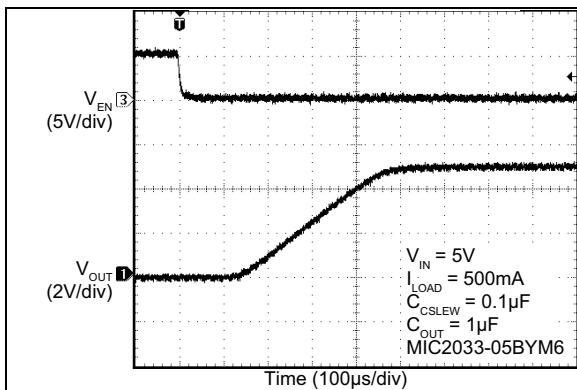

FIGURE 2-20: Enable Turn-On.

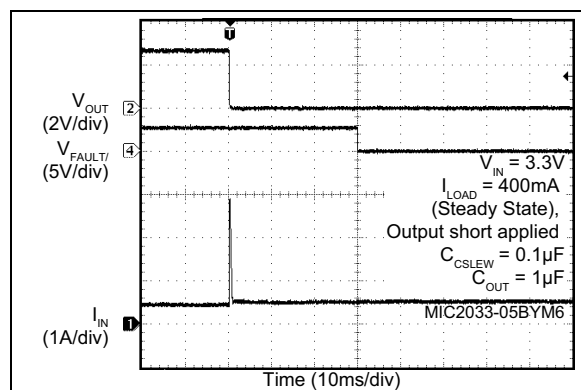

FIGURE 2-23: Current-Limit Response, 400 mA Steady State Load.

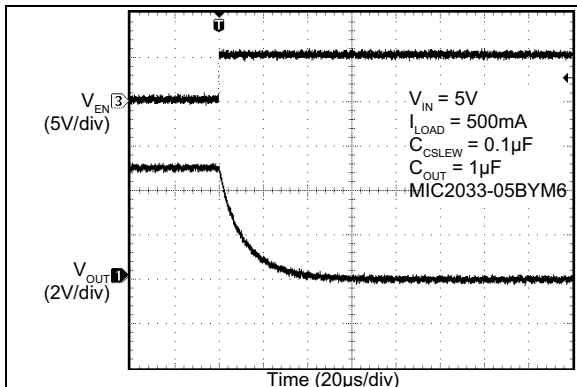

FIGURE 2-21: Enable Turn-Off.

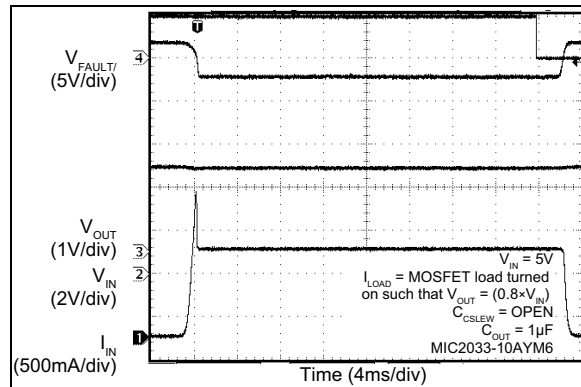

FIGURE 2-24: Current-Limit Response.

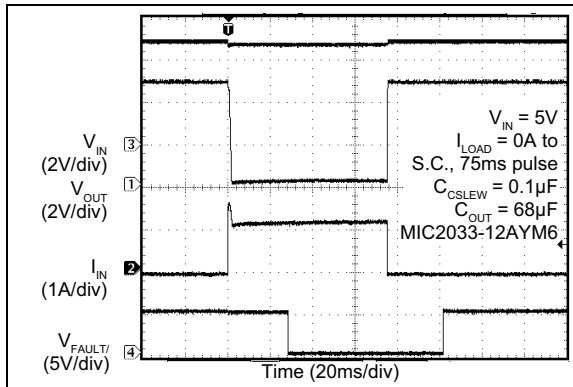

FIGURE 2-25: Output Recovery from Short-Circuit.

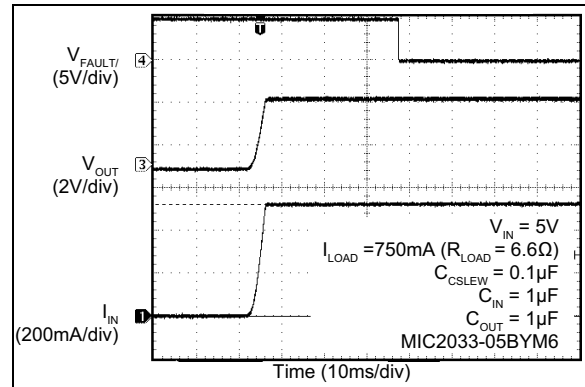

FIGURE 2-28: Turn-On into 50% Overload.

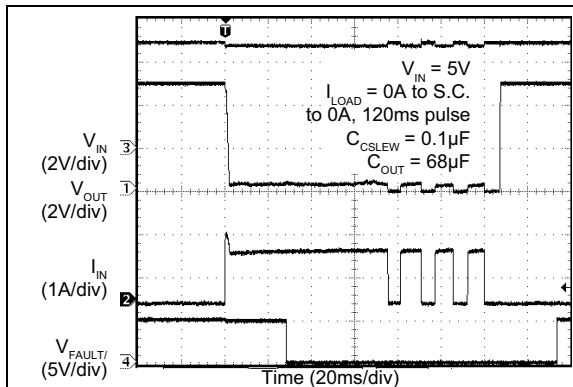

FIGURE 2-26: V_{OUT} Recovery from Thermal Shutdown.

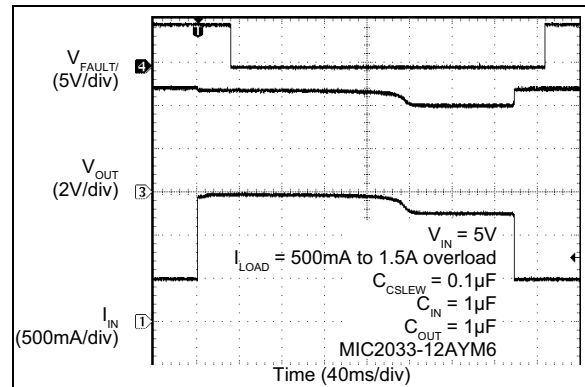

FIGURE 2-29: 1.5A Overload Response.

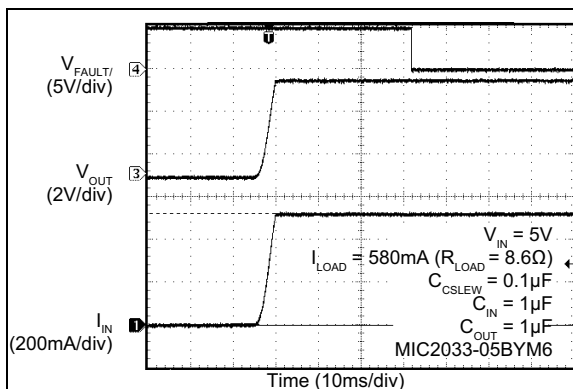

FIGURE 2-27: Turn-On into Minimal Overload.

MIC2033

3.0 PIN DESCRIPTIONS

The descriptions of the pins are listed in [Table 3-1](#).

TABLE 3-1: PIN FUNCTION TABLE

Pin Number SOT-23-6L	Pin Number Thin DFN	Pin Name	Description
1	6	V _{IN}	Input: Power switch and logic supply input.
2	5	GND	Ground: Input and output return pin.
3	4	EN	Enable (Input): Logic compatible, enable control input that allows turn-on/off of the switch. Do not leave the EN pin floating.
4	3	FAULT/	Fault Status Flag (Output): Active-low, open-drain output. A logic-low state indicates an overcurrent or thermal shutdown condition. An overcurrent condition must last longer than t _{FAULT/} in order to assert FAULT/. A pull-up resistor (10 kΩ recommended) to an external supply is required.
5	2	CSLEW	Slew Rate Control: Adjustable soft-start input. Adding a small value capacitor from CSLEW to V _{IN} slows the turn-on time of the power MOSFET.
6	1	V _{OUT}	Switch Output: Power switch output.
—	EP	ePad	Exposed Pad: Exposed pad on bottom side of package. Connect to electrical ground for optimum thermal dissipation.

4.0 FUNCTIONAL DESCRIPTION

The MIC2033 is a high-side MOSFET power distribution switch providing increased system reliability utilizing 5% current-limit accuracy. The MIC2033 has an operating input voltage range from 2.5V to 5.5V and is internally current-limited and has thermal shutdown that protects the device and system.

4.1 Soft-Start

Soft-start reduces the power supply input surge current at startup by controlling the output voltage rise time. The input surge appears while the output capacitor is charged up. A slower output rise time will draw a lower input surge current.

During soft-start, an internal current sink discharges the external capacitor at CSLEW to ground to control the ramp of the output voltage. The output voltage rise time is dependent upon the value of C_{CSLEW} , the input voltage, output voltage, and the current limit. The value of the CSLEW external capacitor is recommended to be 0.1 μ F.

4.2 Input Capacitor

A 1 μ F to 100 μ F ceramic input capacitor is recommended for most applications. The input capacitor must be placed on the same side of the board and next to the MIC2033 to minimize the voltage ringing during transient and short circuit conditions. It is also recommended to use two vias for each end of the capacitor to connect to the power and ground plane.

X7R or X5R dielectric ceramic capacitors are recommended because of their temperature performance. X7R-type capacitors change capacitance by 15% over their operating temperature range and are the most stable type of ceramic capacitors. Z5U and Y5V dielectric capacitors change value by as much as 50% and 60% respectively over their operating temperature ranges. To use a ceramic chip capacitor with Y5V dielectric, the value must be much higher than an X7R ceramic or a tantalum capacitor to ensure the same capacitance value over the operating temperature range.

4.3 Output Capacitor

The output capacitor type and placement criteria are the same as the input capacitor.

The exact amount of capacitance depends upon the specific application. For example, USB applications will typically use 150 μ F, whereas local consumers, such as microcontrollers, may require as little as 1 μ F.

Care must be taken when choosing the output capacitance for inductive loads. Without sufficient capacitance or clamping devices, sudden disconnects

or shorts on VOUT can result in stresses beyond the device's absolute maximum ratings, even for short cables, which will damage the device.

4.4 Enable

The MIC2033 offers either an active-high or active-low enable input (EN) that allows ON/OFF control of the switch output. The current through the device reduces to near zero when the device is shutdown, with only microamperes of leakage current. The EN input may be directly tied to V_{IN} or driven by a voltage that is equal to or less than V_{IN} , but do not leave this pin floating.

Care should be taken to ensure that the EN pin does not exceed V_{IN} by more than 500 mV at any time. This includes at power-up and during load transients. Whenever possible, it is recommended to tie EN to V_{IN} through a pull-up resistor and use an open-drain or open-collector device to change the state.

4.5 Current Limit

The MIC2033 is available with four fixed current-limit settings: 0.5A, 0.8A, 1A, and 1.2A. If the output current exceeds the set current limit, then the MIC2033 switch will enter constant current-limit mode. The maximum allowable current limit may be less than the full specified and/or expected current if the MIC2033 is not mounted on a circuit board with sufficiently low thermal resistance. The MIC2033 responds within 10 μ s to short-circuits to limit the output current and also provides an output fault flag that will assert (low) for an overcurrent condition that lasts longer than 32 ms.

4.6 Thermal Design

To help reduce the thermal resistance, the ePad (underneath the IC) should be soldered to the PCB ground and the placement of thermal vias either underneath or near the ePad is highly recommended. Thermal design requires the following application-specific parameters:

- Maximum ambient temperature (T_A)
- Output current (I_{OUT})
- Input voltage (V_{IN})
- Current Limit (I_{LIMIT})

When the MIC2033 is in constant current-limit mode, it may exceed the overtemperature threshold. If this occurs, the overtemperature condition will shut down the MIC2033 switch and the fault status flag will go active (assert low). After the switch cools down, it will turn on again. The MIC2033 power dissipation can be maximized by either lowering the thermal resistance on the exposed pad (only the DFN package has an exposed pad) on the printed circuit board, or by limiting the maximum allowable ambient temperature.

4.7 Thermal Measurements

It is always wise to measure the IC's case temperature to make sure that it is within its operating limits. Although this might seem like a very elementary task, it is very easy to get erroneous results. The most common mistake is to use the standard thermal couple that comes with the thermal voltage meter. This thermal couple wire gauge is large, typically 22 gauge, and behaves like a heatsink, resulting in a lower case measurement.

There are two suggested methods for measuring the IC case temperature: a thermal couple or an infrared thermometer. If a thermal couple is used, it must be constructed of 36 gauge wire or higher to minimize the wire heatsinking effect. In addition, the thermal couple tip must be covered in either thermal grease or thermal glue to make sure that the thermal couple junction is making good contact to the case of the IC. This thermal couple from Omega (5SC-TT-K-36-36) is adequate for most applications.

To avoid this messy thermal couple grease or glue, an infrared thermometer is recommended. Most infrared thermometers' spot size is too large for an accurate reading on small form factor ICs. However, an IR thermometer from Optris has a 1 mm spot size, which makes it ideal for the 2 mm x 2 mm DFN package. Also, get the optional stand. The stand makes it easy to hold the beam on the IC for long periods of time.

5.0 TIMING DIAGRAMS

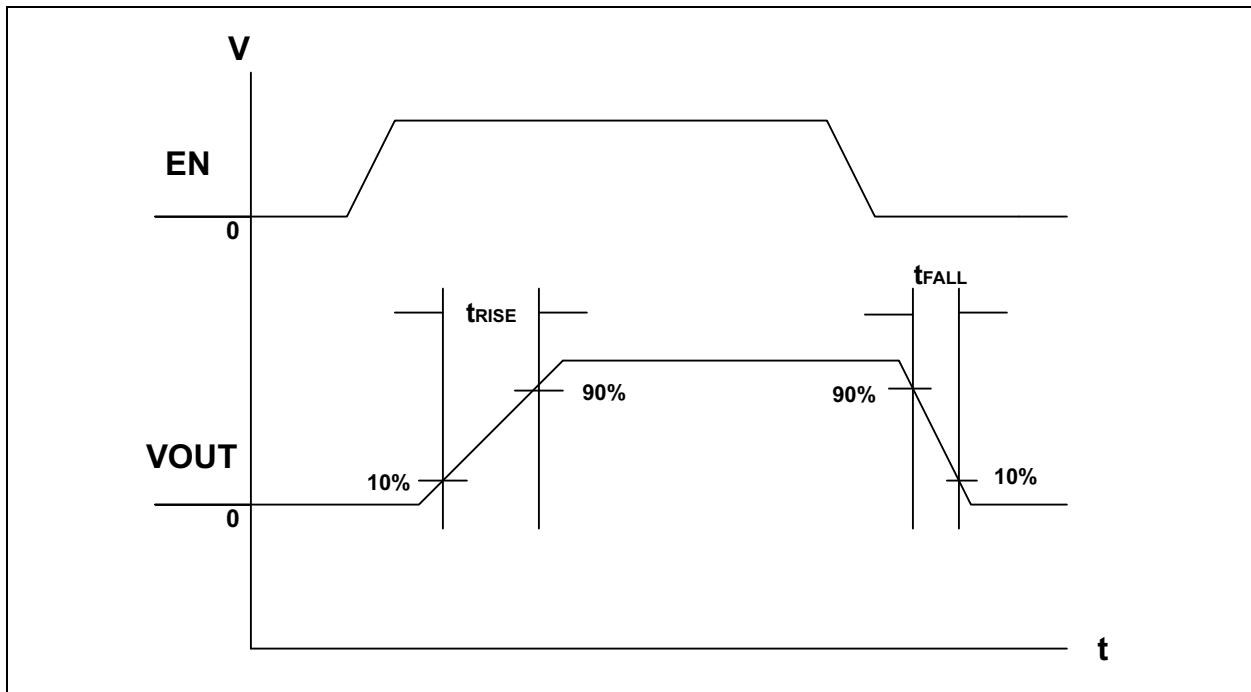

FIGURE 5-1: Output Rise/Fall Time.

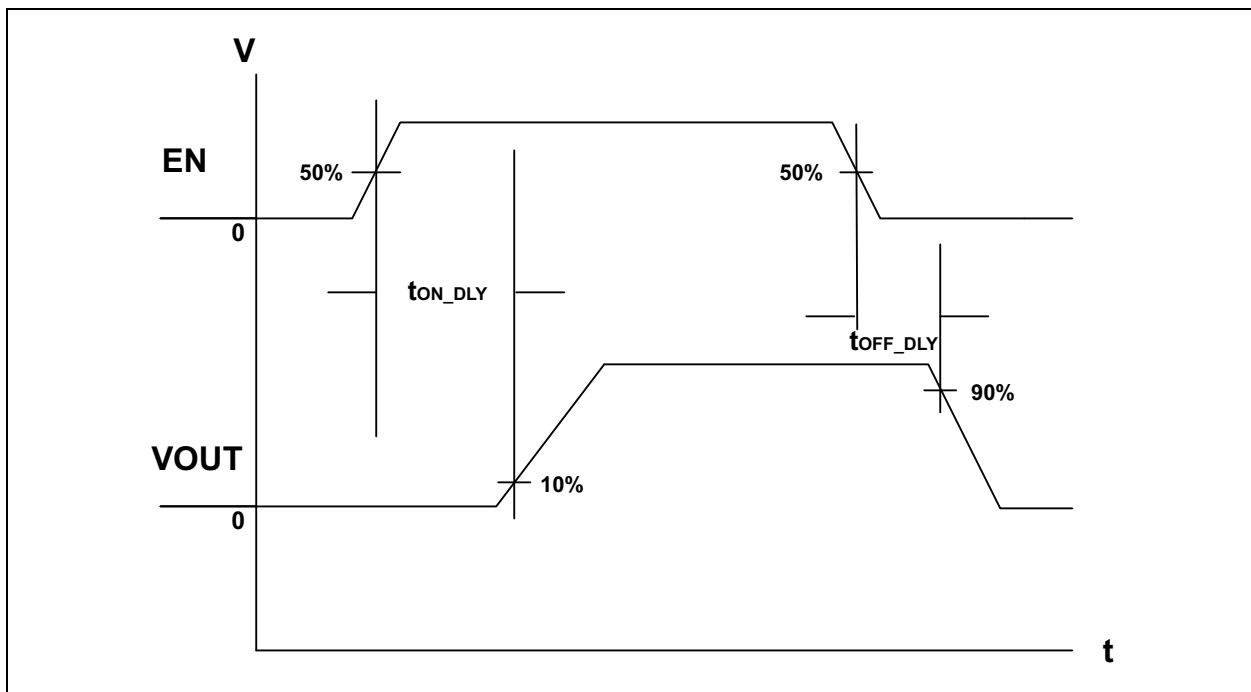

FIGURE 5-2: Turn-On/Off Delay.

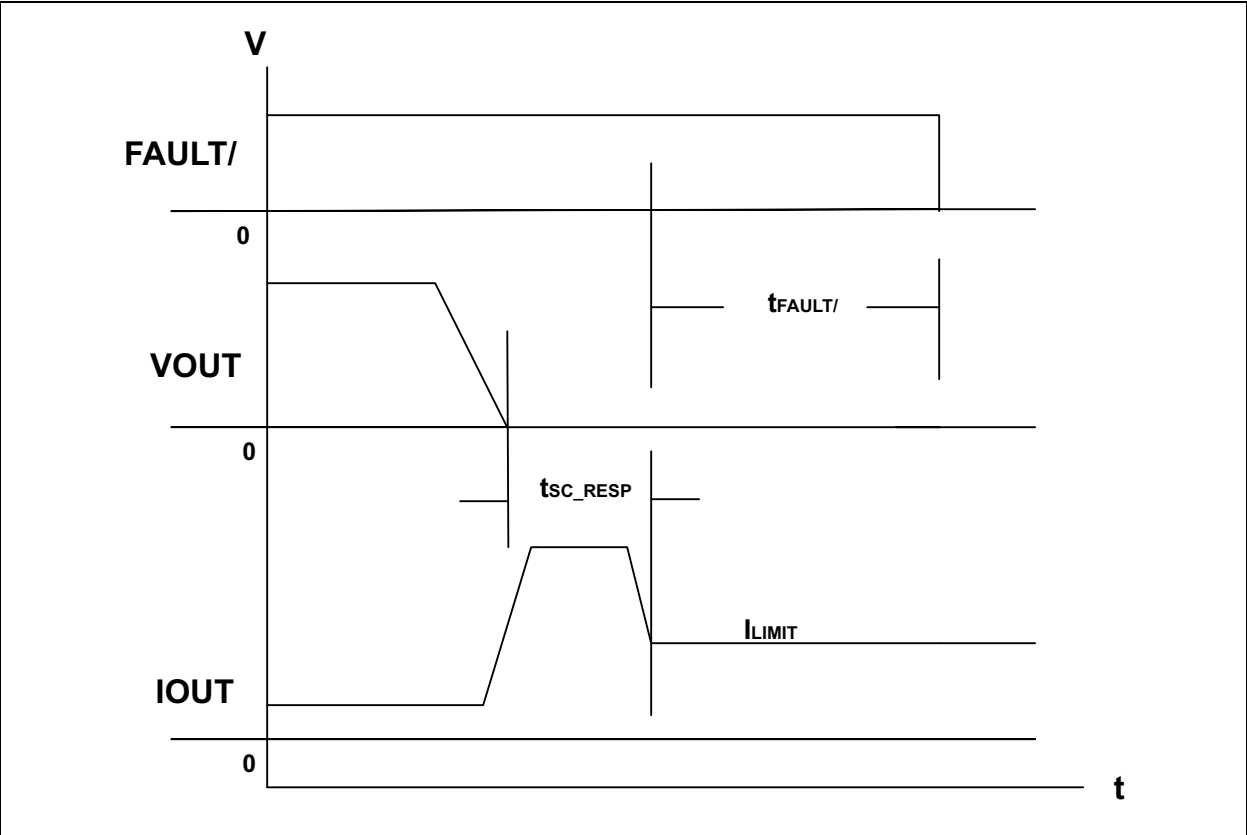
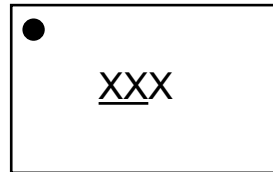

FIGURE 5-3: Short-Circuit Response Time and Overcurrent Fault Flag Delay.

6.0 PACKAGING INFORMATION

6.1 Package Marking Information

6-Lead SOT-23*



Example

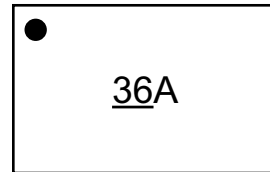

6-Lead TDFN*

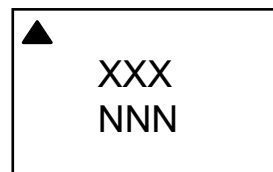

Example

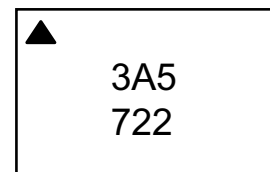

Legend:	XX...X	Product code or customer-specific information
	Y	Year code (last digit of calendar year)
	YY	Year code (last 2 digits of calendar year)
	WW	Week code (week of January 1 is week '01')
	NNN	Alphanumeric traceability code
	(e3)	Pb-free JEDEC® designator for Matte Tin (Sn)
	*	This package is Pb-free. The Pb-free JEDEC designator ((e3)) can be found on the outer packaging for this package.
	•, ▲, ▼	Pin one index is identified by a dot, delta up, or delta down (triangle mark).
Note:	In the event the full Microchip part number cannot be marked on one line, it will be carried over to the next line, thus limiting the number of available characters for customer-specific information. Package may or may not include the corporate logo.	
	Underbar (_) and/or Overbar (¯) symbol may not be to scale.	

MIC2033

6-Lead TDFN 2 mm x 2 mm Package Outline and Recommended Land Pattern

Note: For the most current package drawings, please see the Microchip Packaging Specification located at <http://www.microchip.com/packaging>

TITLE

6 LEAD TDFN 2x2mm PACKAGE OUTLINE & RECOMMENDED LAND PATTERN (0.65mm lead pitch)

DRAWING #	TDFN22-6LD-PL-1	UNIT	MM
-----------	-----------------	------	----

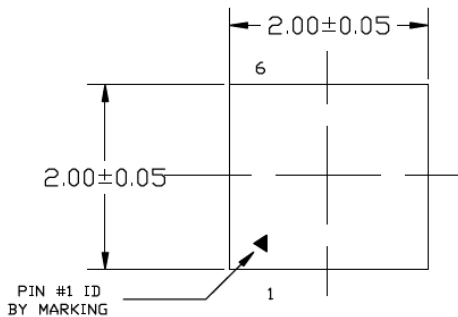

TOP VIEW
NOTE: 1, 2, 3

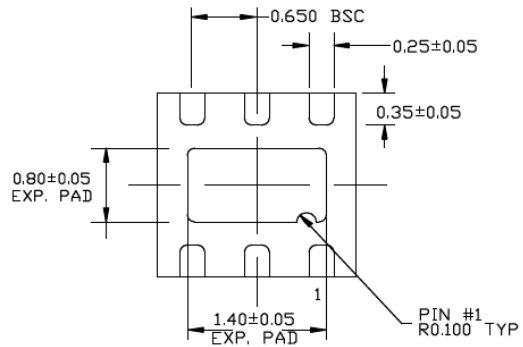

BOTTOM VIEW
NOTE: 1, 2, 3

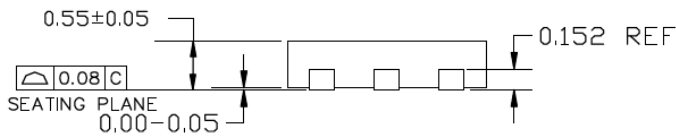

END VIEW
NOTE: 1, 2, 3

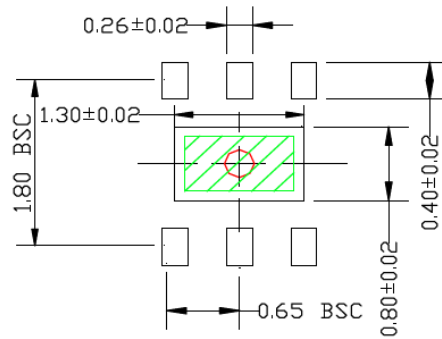

RECOMMENDED LAND PATTERN
NOTE: 4, 5

NOTE:

1. MAX PACKAGE WARPAGE IS 0.08 MM
2. MAX ALLOWABLE BURR IS 0.076MM IN ALL DIRECTIONS
3. PIN #1 IS ON TOP WILL BE LASER MARKED
4. RED CIRCLE IN LAND PATTERN REPRESENTS THERMAL VIA. SIZE SHOULD BE 0.30-0.3 MM IN DIAMETER AND SHOULD BE CONNECTED TO GND FOR MAX THERMAL PERFORMANCE
5. GREEN RECTANGLES (SHADED AREA) REPRESENTS SOLDER STENCIL OPENING ON EXPOSED PAD AREA. SIZE SHOULD BE 1.10x0.60 MM.

6-Lead SOT-23 Package Outline and Recommended Land Pattern

Note: For the most current package drawings, please see the Microchip Packaging Specification located at <http://www.microchip.com/packaging>

TITLE

6 LEAD SOT23 PACKAGE OUTLINE & RECOMMENDED LAND PATTERN

DRAWING # SOT23-6LD-PL-1

UNIT MM

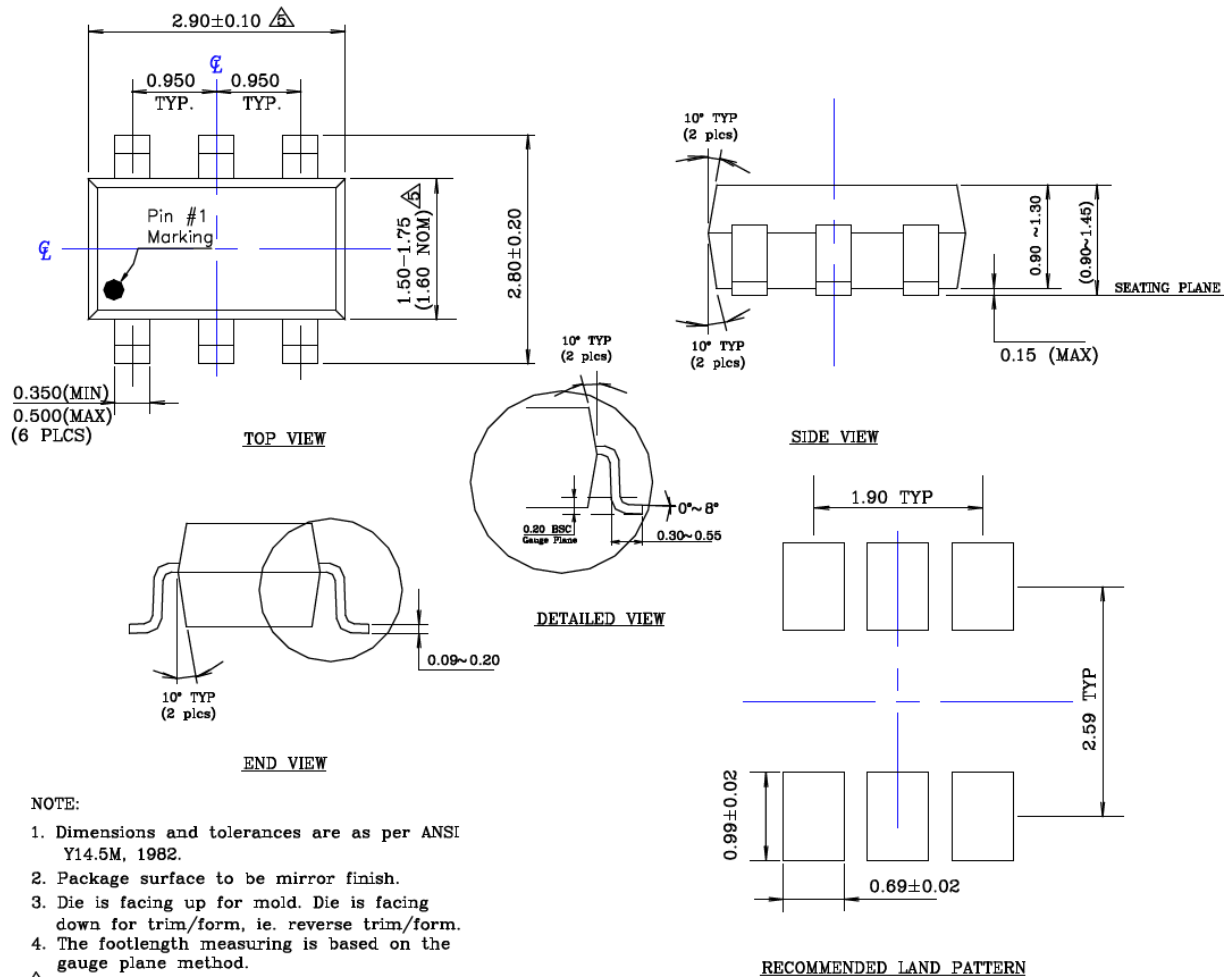

NOTE:

1. Dimensions and tolerances are as per ANSI Y14.5M, 1982.
 2. Package surface to be mirror finish.
 3. Die is facing up for mold. Die is facing down for trim/form, ie. reverse trim/form.
 4. The footlength measuring is based on the gauge plane method.
- △ Dimension are exclusive of mold flash & gate burr.

MIC2033

NOTES:

APPENDIX A: REVISION HISTORY

Revision A (March 2018)

- Converted Micrel document MIC2033 to Microchip data sheet DS20005539A.
- Minor text changes throughout.
- Value of C1 updated in [Typical Application Circuit](#).
- Maximum value of input capacitor corrected in [Input Capacitor](#) section.
- V_{EN} to GND corrected maximum value in [Absolute Maximum Ratings †](#).
- V_{EN} and V_{FAULT} combined in [Operating Ratings ‡](#).
- C_{CSLEW} value corrected to OPEN in [Figure 2-24](#).
- CSLEW external capacitor value in the [Soft-Start](#) section corrected to 0.1 μ F.

Revision B (January 2022)

- Updated package marking drawing in [Section 6.1, Package Marking Information](#).

MIC2033

NOTES:

PRODUCT IDENTIFICATION SYSTEM

To order or obtain information, e.g., on pricing or delivery, contact your local Microchip representative or sales office.

PART NO.	-	XX	X	X	XX	-	XX
Device		Current Limit	Enable	Temperature	Package		Media Type
Device:		MIC2033:					High-Accuracy, High-Side, Fixed Current-Limit Power Switch
Current Limit:		05 = 0.5A					
		55 = 0.55A					
		08 = 0.8A					
		10 = 1.0A					
		12 = 1.2A					
Enable:		A = Active-High					
		B = Active-Low					
Temperature:		Y = -40°C to +125°C					
Package:		M6 = SOT-23-6L					
		MT = 6-Lead 2 mm x 2 mm TDFN (Note 1)					
Media Type:		T5 = 500/Reel					
		TR = 3,000/Reel					
Note 1: Thin DFN is a GREEN RoHS-compliant package. Lead finish is NiPdAu. Mold compound is Halogen Free.							
Examples:							
a) MIC2033-05AYM6-T5: High-Accuracy, High-Side, Fixed Current-Limit Power Switch, 0.5A Current Limit, Active-High Enable, -40°C to +125°C Temp. Range, SOT-23-6L Package, 500/Reel							
b) MIC2033-55AYMT-TR: High-Accuracy, High-Side, Fixed Current-Limit Power Switch, 0.55A Current Limit Active-High Enable, -40°C to +125°C Temp. Range, 6-Pin 2 mm x 2 mm TDFN Package, 3,000/Reel							
c) MIC2033-08BYM6-TR: High-Accuracy, High-Side, Fixed Current-Limit Power Switch, 0.8A Current Limit, Active-Low Enable, -40°C to +125°C Temp. Range, SOT-23-6L Package, 3,000/Reel							
d) MIC2033-10BYMT-T5: High-Accuracy, High-Side, Fixed Current-Limit Power Switch, 1.0A Current Limit Active-Low Enable, -40°C to +125°C Temp. Range, 6-Pin 2 mm x 2 mm TDFN Package, 500/Reel							
e) MIC2033-12AYM6-T5: High-Accuracy, High-Side, Fixed Current-Limit Power Switch, 1.2A Current Limit, Active-High Enable, -40°C to +125°C Temp. Range, SOT-23-6L Package, 500/Reel							
f) MIC2033-12BYMT-TR: High-Accuracy, High-Side, Fixed Current-Limit Power Switch, 1.2A Current Limit Active-Low Enable, -40°C to +125°C Temp. Range, 6-Pin 2 mm x 2 mm TDFN Package, 3,000/Reel							
Note 1: Tape and Reel identifier only appears in the catalog part number description. This identifier is used for ordering purposes and is not printed on the device package. Check with your Microchip Sales Office for package availability with the Tape and Reel option.							

MIC2033

NOTES:

Note the following details of the code protection feature on Microchip products:

- Microchip products meet the specifications contained in their particular Microchip Data Sheet.
- Microchip believes that its family of products is secure when used in the intended manner, within operating specifications, and under normal conditions.
- Microchip values and aggressively protects its intellectual property rights. Attempts to breach the code protection features of Microchip product is strictly prohibited and may violate the Digital Millennium Copyright Act.
- Neither Microchip nor any other semiconductor manufacturer can guarantee the security of its code. Code protection does not mean that we are guaranteeing the product is “unbreakable”. Code protection is constantly evolving. Microchip is committed to continuously improving the code protection features of our products.

This publication and the information herein may be used only with Microchip products, including to design, test, and integrate Microchip products with your application. Use of this information in any other manner violates these terms. Information regarding device applications is provided only for your convenience and may be superseded by updates. It is your responsibility to ensure that your application meets with your specifications. Contact your local Microchip sales office for additional support or, obtain additional support at <https://www.microchip.com/en-us/support/design-help/client-support-services>.

THIS INFORMATION IS PROVIDED BY MICROCHIP "AS IS". MICROCHIP MAKES NO REPRESENTATIONS OR WARRANTIES OF ANY KIND WHETHER EXPRESS OR IMPLIED, WRITTEN OR ORAL, STATUTORY OR OTHERWISE, RELATED TO THE INFORMATION INCLUDING BUT NOT LIMITED TO ANY IMPLIED WARRANTIES OF NON-INFRINGEMENT, MERCHANTABILITY, AND FITNESS FOR A PARTICULAR PURPOSE, OR WARRANTIES RELATED TO ITS CONDITION, QUALITY, OR PERFORMANCE.

IN NO EVENT WILL MICROCHIP BE LIABLE FOR ANY INDIRECT, SPECIAL, PUNITIVE, INCIDENTAL, OR CONSEQUENTIAL LOSS, DAMAGE, COST, OR EXPENSE OF ANY KIND WHATSOEVER RELATED TO THE INFORMATION OR ITS USE, HOWEVER CAUSED, EVEN IF MICROCHIP HAS BEEN ADVISED OF THE POSSIBILITY OR THE DAMAGES ARE FORESEEABLE. TO THE FULLEST EXTENT ALLOWED BY LAW, MICROCHIP'S TOTAL LIABILITY ON ALL CLAIMS IN ANY WAY RELATED TO THE INFORMATION OR ITS USE WILL NOT EXCEED THE AMOUNT OF FEES, IF ANY, THAT YOU HAVE PAID DIRECTLY TO MICROCHIP FOR THE INFORMATION.

Use of Microchip devices in life support and/or safety applications is entirely at the buyer's risk, and the buyer agrees to defend, indemnify and hold harmless Microchip from any and all damages, claims, suits, or expenses resulting from such use. No licenses are conveyed, implicitly or otherwise, under any Microchip intellectual property rights unless otherwise stated.

For information regarding Microchip's Quality Management Systems, please visit www.microchip.com/quality.

Trademarks

The Microchip name and logo, the Microchip logo, Adaptec, AnyRate, AVR, AVR logo, AVR Freaks, BesTime, BitCloud, CryptoMemory, CryptoRF, dsPIC, flexPWR, HELDO, IGLOO, JukeBlox, KeeLoq, Klear, LANCheck, LinkMD, maXStylus, maXTouch, MediaLB, megaAVR, Microsemi, Microsemi logo, MOST, MOST logo, MPLAB, OptoLyzer, PIC, picoPower, PICSTART, PIC32 logo, PolarFire, Prochip Designer, QTouch, SAM-BA, SenGenuity, SpyNIC, SST, SST Logo, SuperFlash, Symmetricom, SyncServer, Tachyon, TimeSource, tinyAVR, UNI/O, Vectron, and XMEGA are registered trademarks of Microchip Technology Incorporated in the U.S.A. and other countries.

AgileSwitch, APT, ClockWorks, The Embedded Control Solutions Company, EtherSynch, Flashtec, Hyper Speed Control, HyperLight Load, IntelliMOS, Libero, motorBench, mTouch, Powermite 3, Precision Edge, ProASIC, ProASIC Plus, ProASIC Plus logo, QuietWire, SmartFusion, SyncWorld, Temux, TimeCesium, TimeHub, TimePictra, TimeProvider, TrueTime, WinPath, and ZL are registered trademarks of Microchip Technology Incorporated in the U.S.A.

Adjacent Key Suppression, AKS, Analog-for-the-Digital Age, Any Capacitor, AnyIn, AnyOut, Augmented Switching, BlueSky, BodyCom, CodeGuard, CryptoAuthentication, CryptoAutomotive, CryptoCompanion, CryptoController, dsPICDEM, dsPICDEM.net, Dynamic Average Matching, DAM, ECAN, Espresso T1S, EtherGREEN, GridTime, IdealBridge, In-Circuit Serial Programming, ICSP, INICnet, Intelligent Paralleling, Inter-Chip Connectivity, JitterBlocker, Knob-on-Display, maxCrypto, maxView, memBrain, Mindi, MiWi, MPASM, MPF, MPLAB Certified logo, MPLIB, MPLINK, MultiTRAK, NetDetach, NVM Express, NVMe, Omniscient Code Generation, PICDEM, PICDEM.net, PICKit, PICtail, PowerSmart, PureSilicon, QMatrix, REAL ICE, Ripple Blocker, RTAX, RTG4, SAM-ICE, Serial Quad I/O, simpleMAP, SimpliPHY, SmartBuffer, SmartHLS, SMART-I.S., storClad, SQL, SuperSwitcher, SuperSwitcher II, Switchtec, SynchroPHY, Total Endurance, TSHARC, USBCheck, VariSense, VectorBlox, VeriPHY, ViewSpan, WiperLock, XpressConnect, and ZENA are trademarks of Microchip Technology Incorporated in the U.S.A. and other countries.

SQTP is a service mark of Microchip Technology Incorporated in the U.S.A.

The Adaptec logo, Frequency on Demand, Silicon Storage Technology, Symmcom, and Trusted Time are registered trademarks of Microchip Technology Inc. in other countries.

GestIC is a registered trademark of Microchip Technology Germany II GmbH & Co. KG, a subsidiary of Microchip Technology Inc., in other countries.

All other trademarks mentioned herein are property of their respective companies.

© 2018 - 2022, Microchip Technology Incorporated and its subsidiaries.

All Rights Reserved.

ISBN: 978-1-5224-9574-1



MICROCHIP

Worldwide Sales and Service

AMERICAS

Corporate Office
2355 West Chandler Blvd.
Chandler, AZ 85224-6199
Tel: 480-792-7200
Fax: 480-792-7277
Technical Support:
<http://www.microchip.com/support>
Web Address:
www.microchip.com

Atlanta
Duluth, GA
Tel: 678-957-9614
Fax: 678-957-1455

Austin, TX
Tel: 512-257-3370

Boston
Westborough, MA
Tel: 774-760-0087
Fax: 774-760-0088

Chicago
Itasca, IL
Tel: 630-285-0071
Fax: 630-285-0075

Dallas
Addison, TX
Tel: 972-818-7423
Fax: 972-818-2924

Detroit
Novi, MI
Tel: 248-848-4000

Houston, TX
Tel: 281-894-5983

Indianapolis
Noblesville, IN
Tel: 317-773-8323
Fax: 317-773-5453
Tel: 317-536-2380

Los Angeles
Mission Viejo, CA
Tel: 949-462-9523
Fax: 949-462-9608
Tel: 951-273-7800

Raleigh, NC
Tel: 919-844-7510

New York, NY
Tel: 631-435-6000

San Jose, CA
Tel: 408-735-9110
Tel: 408-436-4270

Canada - Toronto
Tel: 905-695-1980
Fax: 905-695-2078

ASIA/PACIFIC

Australia - Sydney
Tel: 61-2-9868-6733

China - Beijing
Tel: 86-10-8569-7000

China - Chengdu
Tel: 86-28-8665-5511

China - Chongqing
Tel: 86-23-8980-9588

China - Dongguan
Tel: 86-769-8702-9880

China - Guangzhou
Tel: 86-20-8755-8029

China - Hangzhou
Tel: 86-571-8792-8115

China - Hong Kong SAR
Tel: 852-2943-5100

China - Nanjing
Tel: 86-25-8473-2460

China - Qingdao
Tel: 86-532-8502-7355

China - Shanghai
Tel: 86-21-3326-8000

China - Shenyang
Tel: 86-24-2334-2829

China - Shenzhen
Tel: 86-755-8864-2200

China - Suzhou
Tel: 86-186-6233-1526

China - Wuhan
Tel: 86-27-5980-5300

China - Xian
Tel: 86-29-8833-7252

China - Xiamen
Tel: 86-592-2388138

China - Zhuhai
Tel: 86-756-3210040

ASIA/PACIFIC

India - Bangalore
Tel: 91-80-3090-4444

India - New Delhi
Tel: 91-11-4160-8631

India - Pune
Tel: 91-20-4121-0141

Japan - Osaka
Tel: 81-6-6152-7160

Japan - Tokyo
Tel: 81-3-6880-3770

Korea - Daegu
Tel: 82-53-744-4301

Korea - Seoul
Tel: 82-2-554-7200

Malaysia - Kuala Lumpur
Tel: 60-3-7651-7906

Malaysia - Penang
Tel: 60-4-227-8870

Philippines - Manila
Tel: 63-2-634-9065

Singapore
Tel: 65-6334-8870

Taiwan - Hsin Chu
Tel: 886-3-577-8366

Taiwan - Kaohsiung
Tel: 886-7-213-7830

Taiwan - Taipei
Tel: 886-2-2508-8600

Thailand - Bangkok
Tel: 66-2-694-1351

Vietnam - Ho Chi Minh
Tel: 84-28-5448-2100

EUROPE

Austria - Wels
Tel: 43-7242-2244-39
Fax: 43-7242-2244-393

Denmark - Copenhagen
Tel: 45-4485-5910
Fax: 45-4485-2829

Finland - Espoo
Tel: 358-9-4520-820

France - Paris
Tel: 33-1-69-53-63-20
Fax: 33-1-69-30-90-79

Germany - Garching
Tel: 49-8931-9700

Germany - Haan
Tel: 49-2129-3766400

Germany - Heilbronn
Tel: 49-7131-72400

Germany - Karlsruhe
Tel: 49-721-625370

Germany - Munich
Tel: 49-89-627-144-0
Fax: 49-89-627-144-44

Germany - Rosenheim
Tel: 49-8031-354-560

Israel - Ra'anana
Tel: 972-9-744-7705

Italy - Milan
Tel: 39-0331-742611
Fax: 39-0331-466781

Italy - Padova
Tel: 39-049-7625286

Netherlands - Drunen
Tel: 31-416-690399
Fax: 31-416-690340

Norway - Trondheim
Tel: 47-7288-4388

Poland - Warsaw
Tel: 48-22-3325737

Romania - Bucharest
Tel: 40-21-407-87-50

Spain - Madrid
Tel: 34-91-708-08-90
Fax: 34-91-708-08-91

Sweden - Gothenberg
Tel: 46-31-704-60-40

Sweden - Stockholm
Tel: 46-8-5090-4654

UK - Wokingham
Tel: 44-118-921-5800
Fax: 44-118-921-5820