



Surface Mount Silicon 5 Watt Zener Diodes

DESCRIPTION

The SMBG5333B - SMBG5388B series of surface mount 5.0 watt Zeners provides a selection from 3.3 to 200 volts with different tolerances as identified by suffix letter on the part number. It is equivalent to the JEDEC registered 1N5333 thru 1N5388B with identical electrical characteristics and testing. These parts are available with either Sn/Pb plating or a RoHS compliant matte-tin finish. This Gull-wing design (SMBG) in the DO-215AA allows for visible solder connections. These plastic encapsulated Zeners have a moisture classification of "Level 1" with no dry pack required. Microsemi also offers numerous other Zener products to meet higher and lower power applications.

Important: For the latest information, visit our website <http://www.microsemi.com>.

FEATURES

- Surface mount equivalent to JEDEC registered 1N5333 thru 1N5388 series.
- Ideal for high-density and low-profile mounting.
- Zener voltage available 3.3 V to 200 V.
- Plus/minus 10%, 5% and 2% voltage tolerances are available. (See [part nomenclature](#) block.)
- RoHS compliant versions available.

APPLICATIONS / BENEFITS

- Regulates voltage over broad operating current and temperature ranges.
- Wide selection from 3.3 to 200 V.
- Non-sensitive to ESD per MIL-STD-750 method 1020.
- Withstands high surge stresses.
- Minimal changes of voltage versus current.
- High specified maximum current (I_{ZM}) with adequate heat sinking.
- Moisture classification is "Level 1" per IPC/JEDEC J-STD-020B with no dry pack required.

MAXIMUM RATINGS

Parameters/Test Conditions	Symbol	Value	Unit
Junction and Storage Temperature	T_J and T_{STG}	-65 to +150	°C
Thermal Resistance Junction-to-Lead	$R_{\theta JL}$	25	°C/W
Thermal Resistance Junction-to-Ambient ⁽¹⁾	$R_{\theta JA}$	90	°C/W
Off-State Power Dissipation @ 25 °C ⁽²⁾	P_D	5.0	W
Forward Voltage @ 1.0 A	V_F	1.2	V
Solder Temperature @ 10 s	T_{SP}	260	°C

- Notes:**
1. When mounted on FR4 PC board (1oz Cu) with recommended footprint (see [pad layout](#)).
 2. 5 watts at $T_L \leq 25$ °C, or 1.38 watts at $T_A = 25$ °C when mounted on FR4 PC board with recommended footprint (also see [Figure 1](#)).

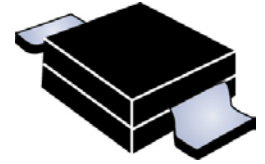

DO-215AA Gull-wing Package

NOTE: All SMB series are equivalent to prior SMS package identifications.

Also available in:

DO-214AA Package

(J-bend surface mount)
 [SMBJ5333 – SMBJ5388](#)

T-18 Package

(axial-leaded)
 [1N5333 – 1N5388](#)

MSC – Lawrence

6 Lake Street,
 Lawrence, MA 01841
 Tel: 1-800-446-1158 or
 (978) 620-2600
 Fax: (978) 689-0803

MSC – Ireland

Gort Road Business Park,
 Ennis, Co. Clare, Ireland
 Tel: +353 (0) 65 6840044
 Fax: +353 (0) 65 6822298

Website:

www.microsemi.com

MECHANICAL and PACKAGING

- CASE: Void-free transfer molded thermosetting epoxy body meeting UL94V-0.
- TERMINALS: Gull-wing tin-lead or RoHS compliant annealed matte-tin plating solderable per MIL-STD-750, method 2026.
- MARKING: Part number without SMBx prefix (e.g. 5334B, 5334Be3, MX5348C, 5376A, etc.).
- POLARITY: Cathode indicated by band. Diode to be operated with the banded end positive with respect to the opposite end.
- TAPE & REEL option: Standard per EIA-481-1-A with 12 mm tape (add "TR" suffix to part number). Consult factory for quantities.
- WEIGHT: 0.1 grams.
- See [Package Dimensions](#) on last page.

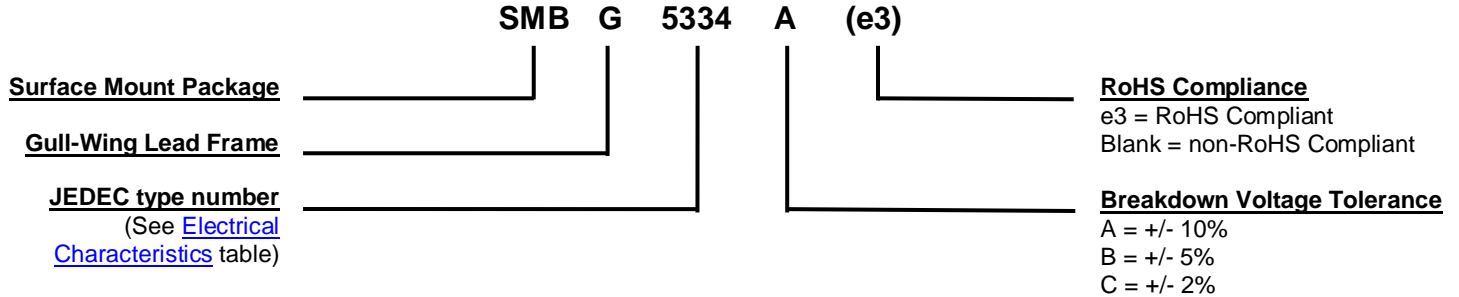
PART NOMENCLATURE

SYMBOLS & DEFINITIONS

Symbol	Definition
I_R	Reverse Current: The maximum reverse (leakage) current that will flow at the specified voltage and temperature.
I_Z, I_{ZT}, I_{ZK}	Regulator Current: The dc regulator current (I_Z), at a specified test point (I_{ZT}), near breakdown knee (I_{ZK}).
I_{ZM}	Maximum Regulator (Zener) Current: The maximum rated dc current for the specified power rating.
I_{ZSM}	Maximum Zener Surge Current: The non-repetitive peak value of Zener surge current at a specified wave form.
V_R	Reverse Voltage: The reverse voltage dc value, no alternating component.
V_Z	Zener Voltage: The Zener voltage the device will exhibit at a specified current (I_Z) in its breakdown region.
Z_{ZT} or Z_{ZK}	Dynamic Impedance: The small signal impedance of the diode when biased to operate in its breakdown region at a specified rms current modulation (typically 10% of I_{ZT} or I_{ZK}) and superimposed on I_{ZT} or I_{ZK} respectively.

ELECTRICAL CHARACTERISTICS @ T_L = 30 °C

TYPE NUMBER	REGULATOR VOLTAGE (V _Z)	TEST CURRENT (I _{ZT})	MAXIMUM DYNAMIC IMPEDANCE (Z _Z) (A & B suffix only)	MAXIMUM REVERSE CURRENT (I _R)	I _R TEST VOLTAGE (V _R) (A suffix only)	I _R TEST VOLTAGE (V _R) (B & C suffix only)	MAXIMUM REGULATOR CURRENT (I _{ZM}) (B & C suffix only)	MAXIMUM DYNAMIC KNEE IMPEDANCE Z _{ZK} @ 1.0 mA	MAXIMUM SURGE CURRENT (I _{ZSM})
	V	mA	Ohms	µA	V	V	mA	Ohms	Amps
SMBG5333B	3.3	380	3.0	300	1.0	1.0	1440	400	20
SMBG5334B	3.6	350	2.5	150	1.0	1.0	1320	500	18.7
SMBG5335B	3.9	320	2.0	50	1.0	1.0	1220	500	17.6
SMBG5336B	4.3	290	2.0	10	1.0	1.0	1100	500	16.4
SMBG5337B	4.7	260	2.0	5.0	1.0	1.0	1010	450	15.3
SMBG5338B	5.1	240	1.5	1.0	1.0	1.0	930	400	14.4
SMBG5339B	5.6	220	1.0	1.0	2.0	2.0	865	400	13.4
SMBG5340B	6.0	200	1.0	1.0	3.0	3.0	790	300	12.7
SMBG5341B	6.2	200	1.0	1.0	3.0	3.0	765	200	12.4
SMBG5342B	6.8	175	1.0	10	4.9	5.2	700	200	11.5
SMBG5343B	7.5	175	1.5	10	5.4	5.7	630	200	10.7
SMBG5344B	8.2	150	1.5	10	5.9	6.2	580	200	10
SMBG5345B	8.7	150	2.0	10	6.25	6.6	545	200	9.5
SMBG5346B	9.1	150	2.0	7.5	6.6	6.9	520	150	9.2
SMBG5347B	10	125	2.0	5.0	7.2	7.6	475	125	8.6
SMBG5348B	11	125	2.5	5.0	8.0	8.4	430	125	8.0
SMBG5349B	12	100	2.5	2.0	8.6	9.1	395	125	7.5
SMBG5350B	13	100	2.5	1.0	9.4	9.9	365	100	7.0
SMBG5351B	14	100	2.5	1.0	10.1	10.6	340	75	6.7
SMBG5352B	15	75	2.5	1.0	10.8	11.5	315	75	6.3
SMBG5353B	16	75	2.5	1.0	11.5	12.2	295	75	6.0
SMBG5354B	17	70	2.5	0.5	12.2	12.9	280	75	5.8
SMBG5355B	18	65	2.5	0.5	13	13.7	264	75	5.5
SMBG5356B	19	65	3.0	0.5	13.7	14.4	250	75	5.3
SMBG5357B	20	65	3.0	0.5	14.4	15.2	237	75	5.1
SMBG5358B	22	50	3.5	0.5	15.8	16.7	216	75	4.7
SMBG5359B	24	50	3.5	0.5	17.3	18.2	198	100	4.4
SMBG5360B	25	50	4.0	0.5	18	19	190	110	4.3
SMBG5361B	27	50	5.0	0.5	19.4	20.6	176	120	4.1
SMBG5362B	28	50	6.0	0.5	20.1	21.2	170	130	3.9
SMBG5363B	30	40	8.0	0.5	21.6	22.8	158	140	3.7
SMBG5364B	33	40	10	0.5	23.8	25.1	144	150	3.5
SMBG5365B	36	30	11	0.5	25.9	27.4	132	160	3.3
SMBG5366B	39	30	14	0.5	28.1	29.7	122	170	3.1
SMBG5367B	43	30	20	0.5	31	32.7	110	190	2.8
SMBG5368B	47	25	25	0.5	33.8	35.8	100	210	2.7
SMBG5369B	51	25	27	0.5	36.7	38.8	93	230	2.5
SMBG5370B	56	20	35	0.5	40.3	42.6	86	280	2.3
SMBG5371B	60	20	40	0.5	43	45.5	79	350	2.2
SMBG5372B	62	20	42	0.5	44.6	47.1	76	400	2.1
SMBG5373B	68	20	44	0.5	49	51.7	70	500	2.0
SMBG5374B	75	20	45	0.5	54	56	63	620	1.9
SMBG5375B	82	15	65	0.5	59	62.2	58	720	1.8
SMBG5376B	87	15	75	0.5	63	66	54.5	760	1.7
SMBG5377B	91	15	75	0.5	65.5	69.2	52.5	760	1.6
SMBG5378B	100	12	90	0.5	72	76	47.5	800	1.5
SMBG5379B	110	12	125	0.5	79.2	83.6	43	1000	1.4
SMBG5380B	120	10	170	0.5	86.4	91.2	39.5	1150	1.3
SMBG5381B	130	10	190	0.5	93.6	98.8	36.6	1250	1.2
SMBG5382B	140	8.0	230	0.5	101	106	34	1500	1.2
SMBG5383B	150	8.0	330	0.5	108	114	31.6	1500	1.1
SMBG5384B	160	8.0	350	0.5	115	122	29.4	1650	1.1
SMBG5385B	170	8.0	380	0.5	122	129	28	1750	1.0
SMBG5386B	180	5.0	430	0.5	130	137	26.4	1750	1.0
SMBG5387B	190	5.0	450	0.5	137	144	25	1850	0.9
SMBG5388B	200	5.0	480	0.5	144	152	23.6	1850	0.9

NOTE 1: Zener voltage (V_Z) is measured at T_L = 25 °C (+8, -2 °C). Voltage measurement to be performed 40 ±10 milliseconds after application of dc current.

NOTE 2: The Zener impedance is derived from 1 kHz ac voltage resulting from an ac current modulation having an rms value equal to 10% of the dc Zener current (I_{ZT} or I_{ZK}) superimposed on I_{ZT} or I_{ZK}. See [MicroNote 202](#) for Zener impedance variation with different operating currents.

NOTE 3: The maximum current (I_{ZM}) shown is for a ± 5% tolerance devices. The I_{ZM} for other tolerances can be calculated using the formula: I_{ZM} = P/V_{ZM} where V_{ZM} is the V_Z at the high end of the voltage tolerance specified and P is the rated power for the method of mounting.

NOTE 4: The surge current (I_{ZSM}) is specified as the maximum peak of a non-recurrent half-sine wave of 8.3 ms duration.

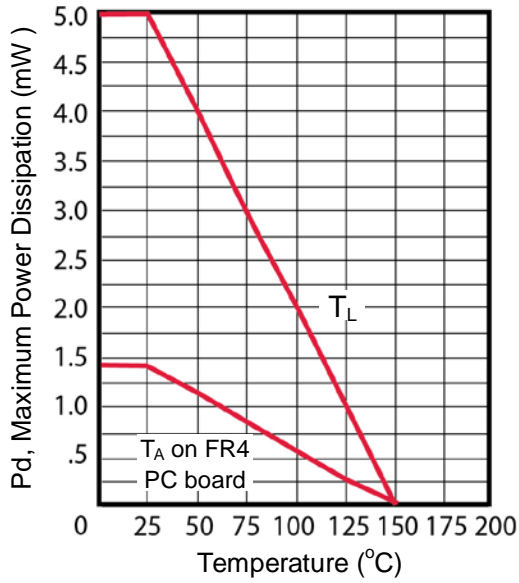
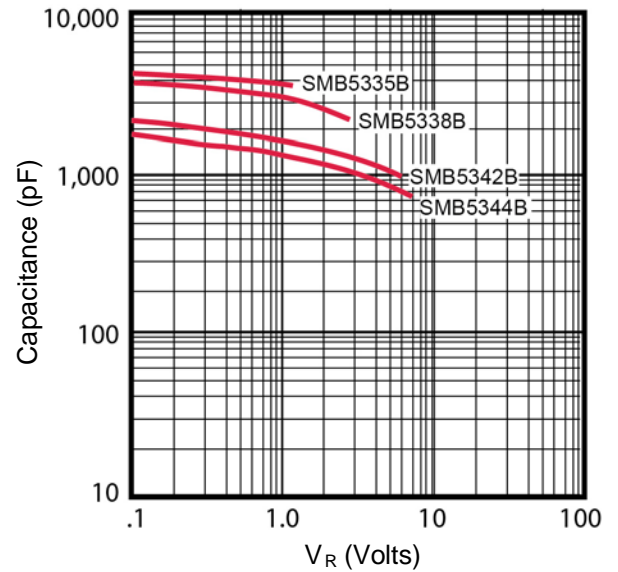
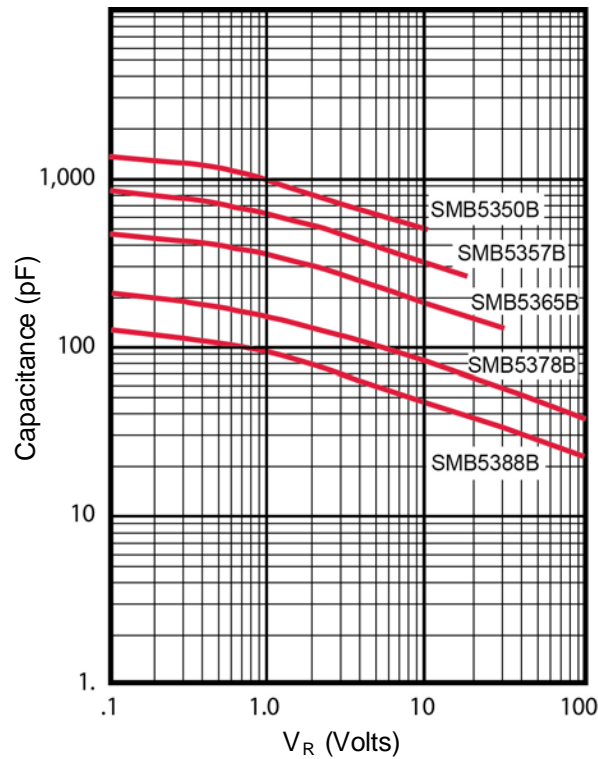
GRAPHS

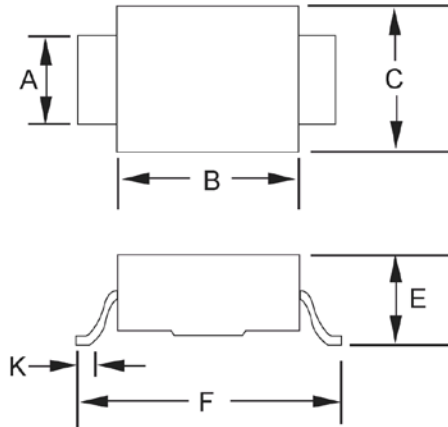
FIGURE 1 – Power Derating Curve

FIGURE 2 – Capacitance vs. Zener Voltage

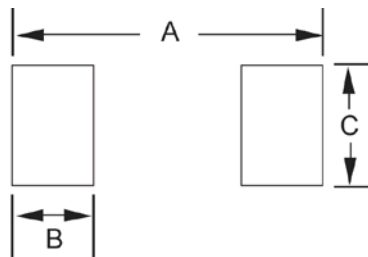
FIGURE 3 - Typical Capacitance vs. Reverse Voltage for 5 Watt Zeners

PACKAGE DIMENSIONS

Ltr	Dimensions			
	Inch		Millimeters	
	Min	Max	Min	Max
A	.077	.083	1.96	2.10
B	.160	.180	4.06	4.57
C	.130	.155	3.30	3.94
E	.077	.104	1.95	2.65
F	.235	.255	5.97	6.48
K	.015	.030	.381	.762

PAD LAYOUT

	INCH	mm
A	0.320	8.13
B	0.085	2.16
C	0.110	2.79