

General Description

TPBL9198 is a high-performance, 300mA LDO regulator, offering extremely high PSRR and ultra-low dropout. Ideal for portable RF and wireless applications with demanding performance and space requirements.

The TPBL9198 is available in 5pin SOT23-5, Package .the output standards of 1.2V, 1.5V, 1.8V, 2.5V, 2.8V, 2.9V, 3.0V, 3.3V, 3.6V

Features

- Quiescent Current: 70uA
- PSRR: 70dB@1KHz
- < 1uA current at shutdown mode
- Output current: 300mA(Typ.)
- SOT23-5 package

Applications

- CDM/GSM mobile phone
- PDAs /MP3
- Audio/Video equipment

Ordering Information

TPBL9198-33BAPRN

PRN=SOT23-5 Package

BA=active high with external pull down

Output voltage: 12=1.2V

15=1.5V

18=1.8V

25=2.5V

28=2.8V

29=2.9V

30=3.0V

33=3.3V

36=3.6V

TP= TECH PUBLIC

BLOCK DIAGRAM

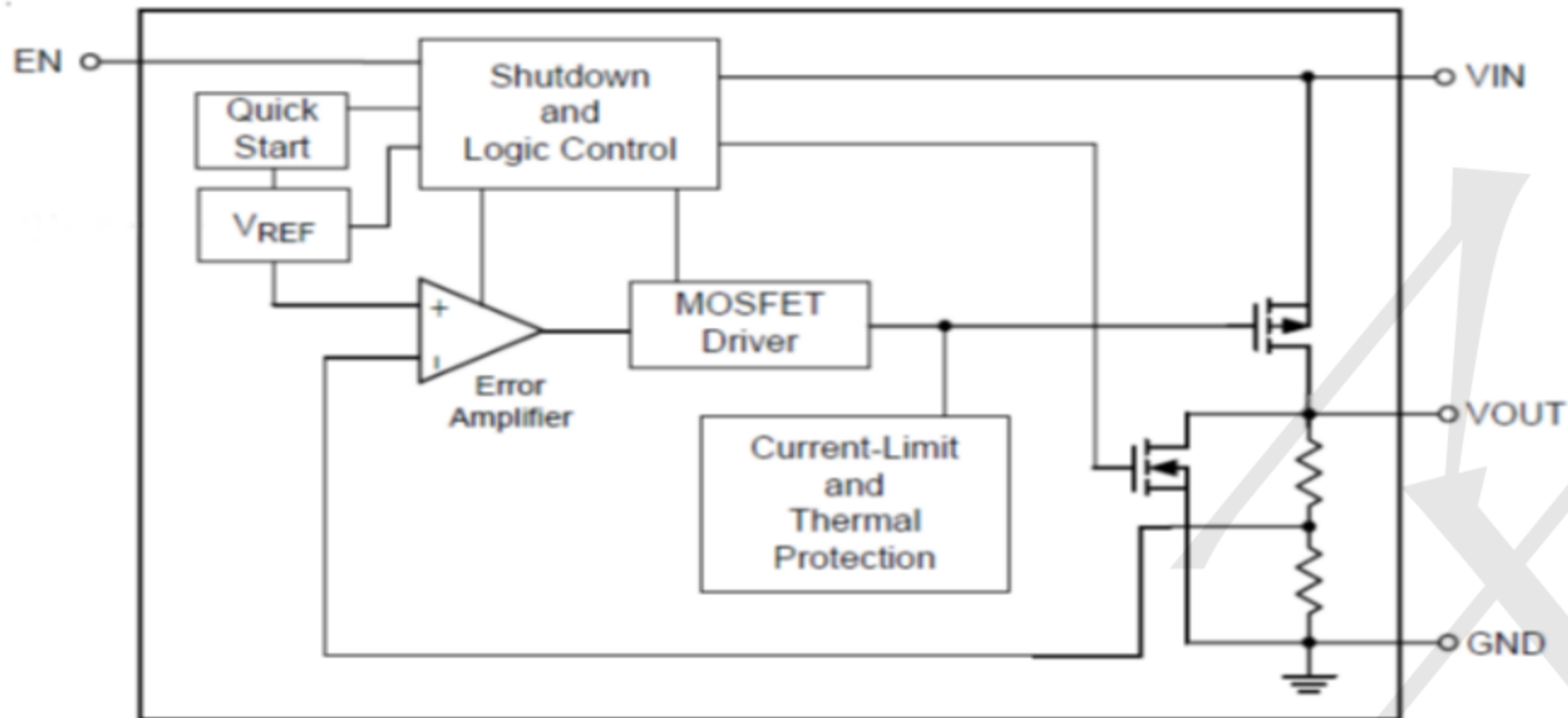

PIN CONFIGURATION

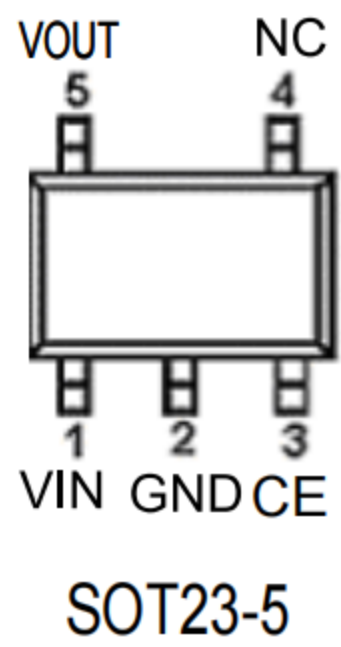

Pin Name	Function
VIN	Supply power
GND	Ground
CE	Enable pin
NC	NC
VOUT	Voltage output

Absolute Maximum Rating ($T_A=25^\circ\text{C}$ unless otherwise noted)

Parameter	Symbol	Maximum Rating		Unit
Input Voltage	V_{IN}	6		V
Output Voltage	V_{OUT}	$V_{SS}-0.3 \sim V_{IN}+0.3$		
Output Current	I_{out}	450		mA
Power Dissipation	P_D	SOT-23-5	250	mW
Operating Ambient Temperature	T_{opr}	-40~+85		°C
Storage Temperature	T_{stg}	-40~+125		

Electrical Characteristics ($T = 25^\circ\text{C}$ unless otherwise noted)

($V_{in}=V_{out}+1V, C_{in}=C_{out}=1\mu F, T_a=25^\circ\text{C}$)

PARAMETER	SYMBOL	CONDITIONS	MIN	TYP	MAX	UNITS
Output Voltage	$V_{OUT(E)}$ (Note 2)	$I_{OUT}=40\text{mA},$ $V_{IN}=V_{out}+1V$	X 0.98	$V_{OUT(T)}$ (Note 1)	X 1.02	V
Input Voltage	V_{IN}				6	V
Max. Output Current	I_{OUTmax}	$V_{IN}=V_{out}+1V$		300		mA
Load Regulation	ΔV_{OUT}	$V_{IN}=V_{out}+1V,$ $1\text{mA} \leq I_{OUT} \leq 100\text{mA}$		50		mV
Dropout Voltage (Note 3)	V_{dif1}	$I_{OUT} = 100\text{mA}$		90		mV
	V_{dif2}	$I_{OUT} = 200\text{mA}$		230		mV
Supply Current	I_{SS}	$V_{IN}=V_{out}+1V$		70		μA
Standby Current	I_{CEL}	$V_{ce}=0V$		1		μA
Line Regulation	$\frac{\Delta V_{OUT}}{\Delta V_{IN} \cdot V_{OUT}}$	$I_{OUT} = 40\text{mA}$ $V_{out}+1V \leq V_{IN} \leq 8V$		0.05		%/V
Output Noise	e_n	$I_{OUT} = 40\text{mA},$ 300Hz~50kHz		50		μVrms
Ripple Rejection Rate	PSRR	$V_{in} = [V_{out}+1]V$ +1Vp-pAC $I_{OUT} = 40\text{mA}, f=1\text{kHz}$		70		dB

TYPICAL APPLICATION

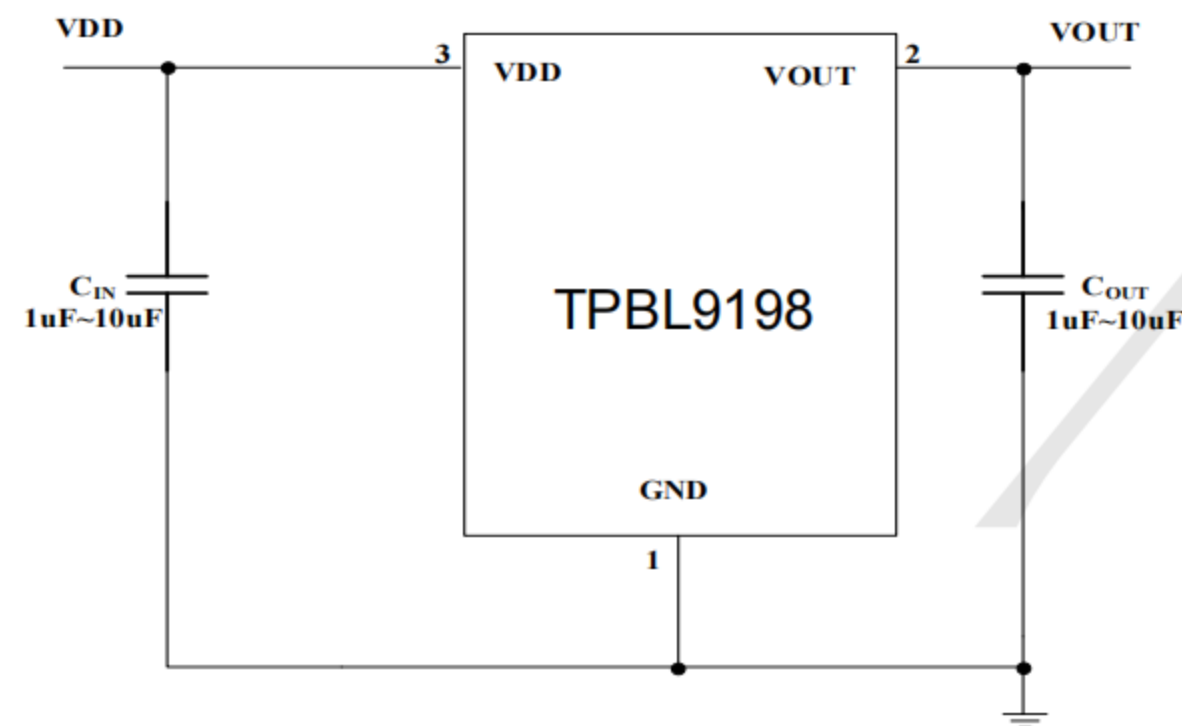

Figure 1: Application circuit of Fixed V_{OUT} LDO

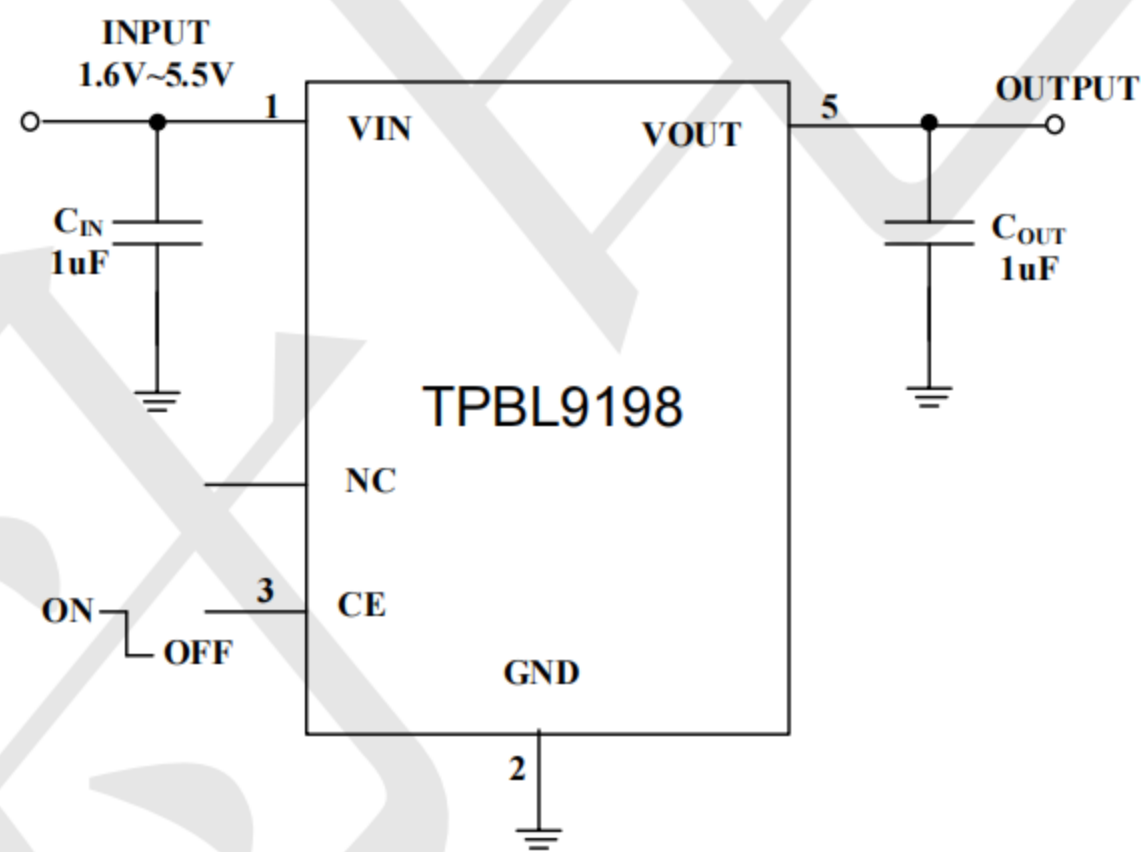
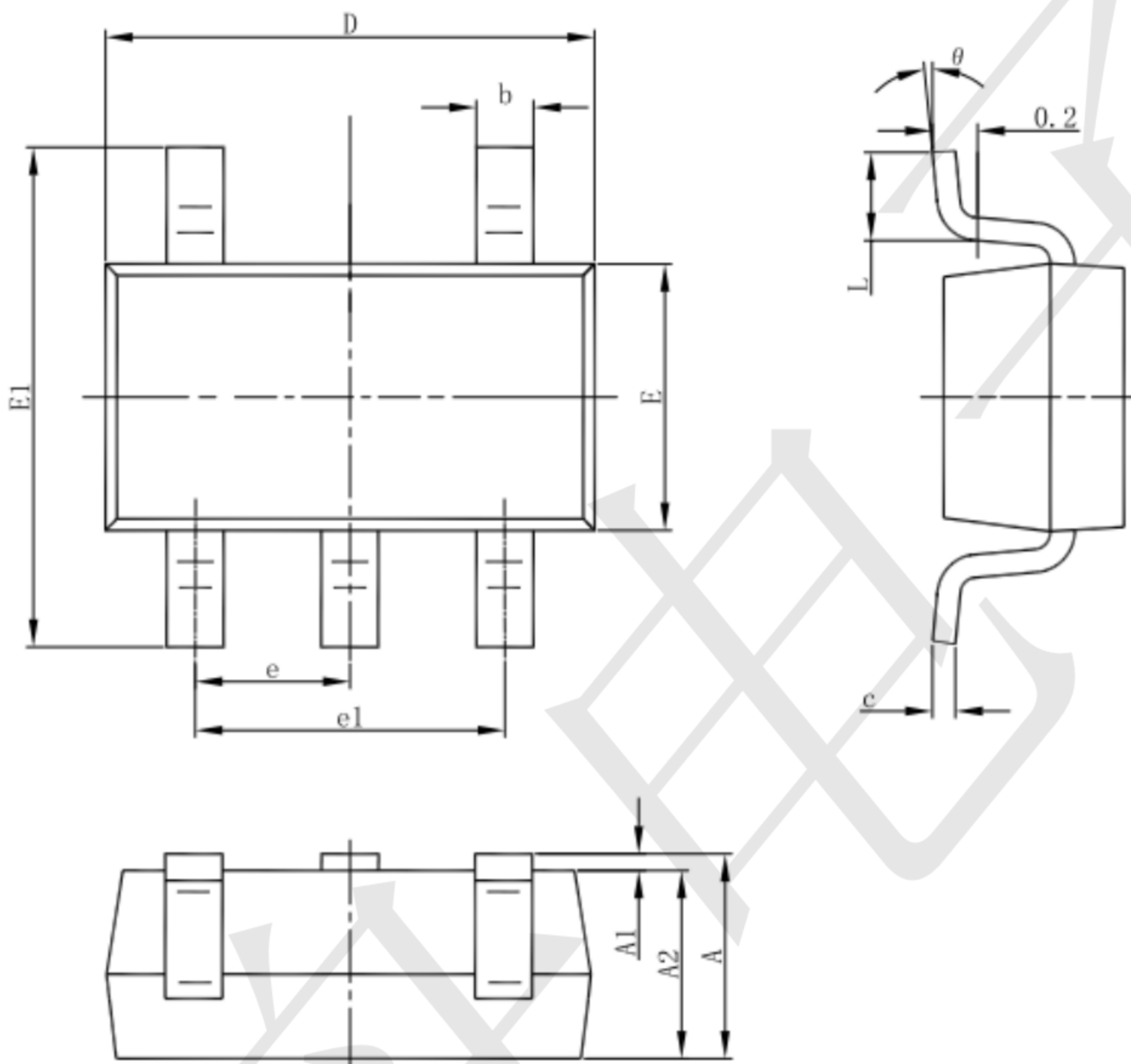

Figure 2: Application circuit of Fixed V_{OUT} LDO with enable function

Package information

SOT23-5



Symbol	Dimensions In Millimeters		Dimensions In Inches	
	Min	Max	Min	Max
A	1.050	1.250	0.041	0.049
A1	0.000	0.100	0.000	0.004
A2	1.050	1.150	0.041	0.045
b	0.300	0.500	0.012	0.020
c	0.100	0.200	0.004	0.008
D	2.820	3.020	0.111	0.119
E	1.500	1.700	0.059	0.067
E1	2.650	2.950	0.104	0.116
e	0.950(BSC)		0.037(BSC)	
e1	1.800	2.000	0.071	0.079
L	0.300	0.600	0.012	0.024
theta	0°	8°	0°	8°