

General Description

NJM2107F is a single operational amplifier of ultra miniature surface mount package.

NJM2107F has features of low operating supply voltage and low saturation output voltage. The NJM2107F is suitable for small electronic equipments and hybrid circuits.

Features

- Operating Voltage ($V_+/V_- = \pm 1.0V$ to $\pm 3.5V$)
- Low Output Saturation: 4Vp-p at single 5V supply
- V_- Shield Plate between +input and -input
- Suitable Pin Arrangement for Application
- Bipolar Technology

Ordering Information

Name	Package	Packing Specification
NJM2107F	SOT-23-5L	3000 /7inch Tape& Reel

PIN CONFIGURATION

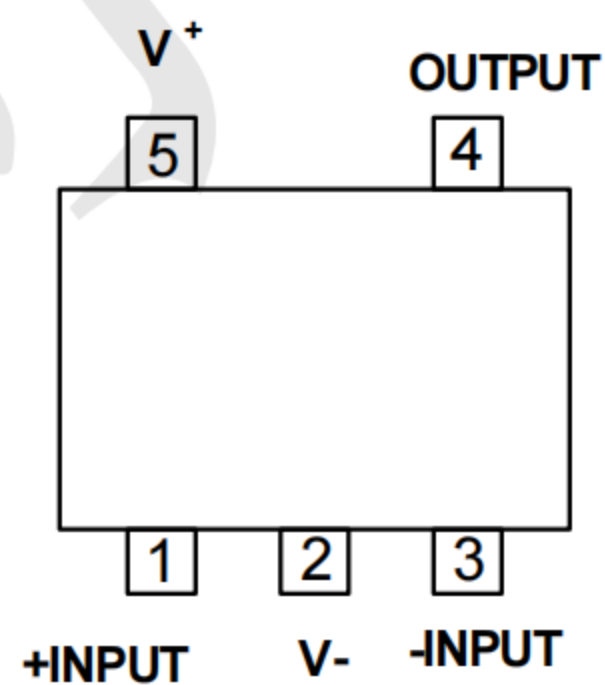

Marking:2107

Absolute Maximum Ratings

Characteristic	Symbol	Value	Unit
Supply Voltage	V^+/V^-	± 3.5	V
Differential Input Voltage	V_{ID}	± 7	V
Input Voltage	V_{IC}	± 3.5	V
Power Dissipation	P_D	200	mW
Operating Temperature	T_{opr}	$-40 \sim +85$	$^{\circ}\text{C}$
Storage Temperature	T_{stg}	$-40 \sim +125$	$^{\circ}\text{C}$

Electrical Characteristics

(unless otherwise specified: $T_a=25^{\circ}\text{C}$, $V^+/V^- = 2.5\text{V}$)

Characteristics	Symbol	Test conditions	Min	Typ	Max	Unit
Input Offset Voltage	V_{IO}	$R_s=10\text{k}\Omega$		1	6	mV
Input Offset Current	I_{IO}	$I^+ - I^-$		5	200	nA
Input Bias Current	I_B			100	500	nA
Input Common Mode Voltage Range	V_{ICM}		± 1.5			V
Large Signal Voltage Gain	A_V	$R_L=10\text{ k}\Omega, V_o=\pm 2\text{V}$	60	80		dB
Output Voltage Swing	V_{OM}	$R_L=2.5\text{ k}\Omega$	± 2.0	± 2.2		V
Common Mode Rejection Ratio	CMR	$R_s \leq 10\text{k}\Omega$	60	80		dB
Supply Voltage Rejection Ratio	SVR	$R_s \leq 10\text{k}\Omega$	60	70		dB
Slew Rate	SR	$V_{IN}=\pm 1\text{V}_{p-p}, A_{CL}=+1$		3		$\text{V}/\mu\text{s}$
Operating Current	I_{cc}		1	2	3	mA

EQUIVALENT CIRCUIT

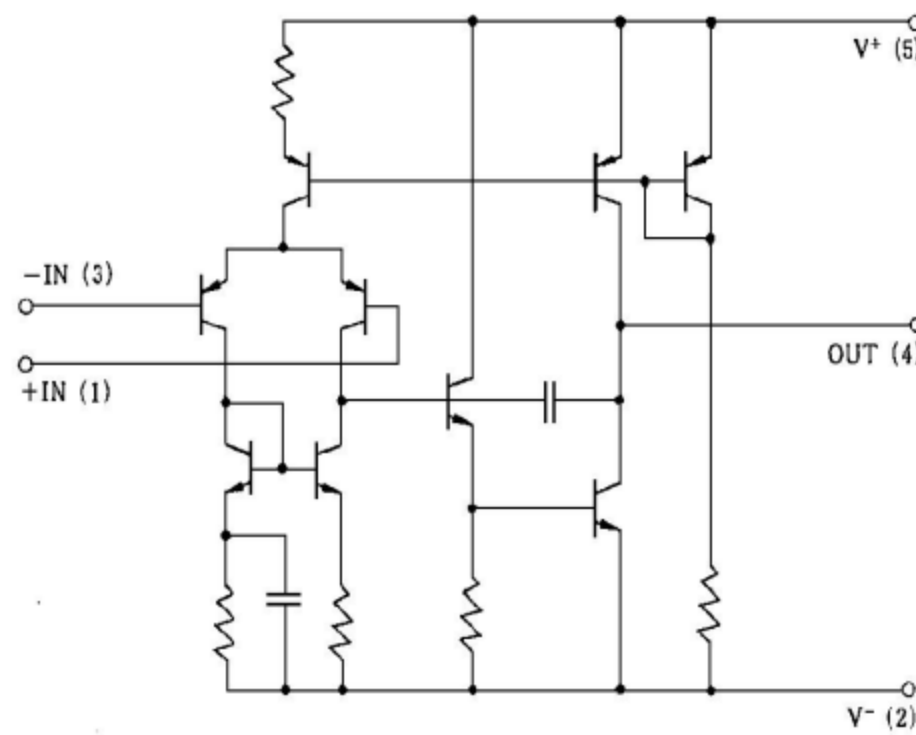

TEST CIRCUIT

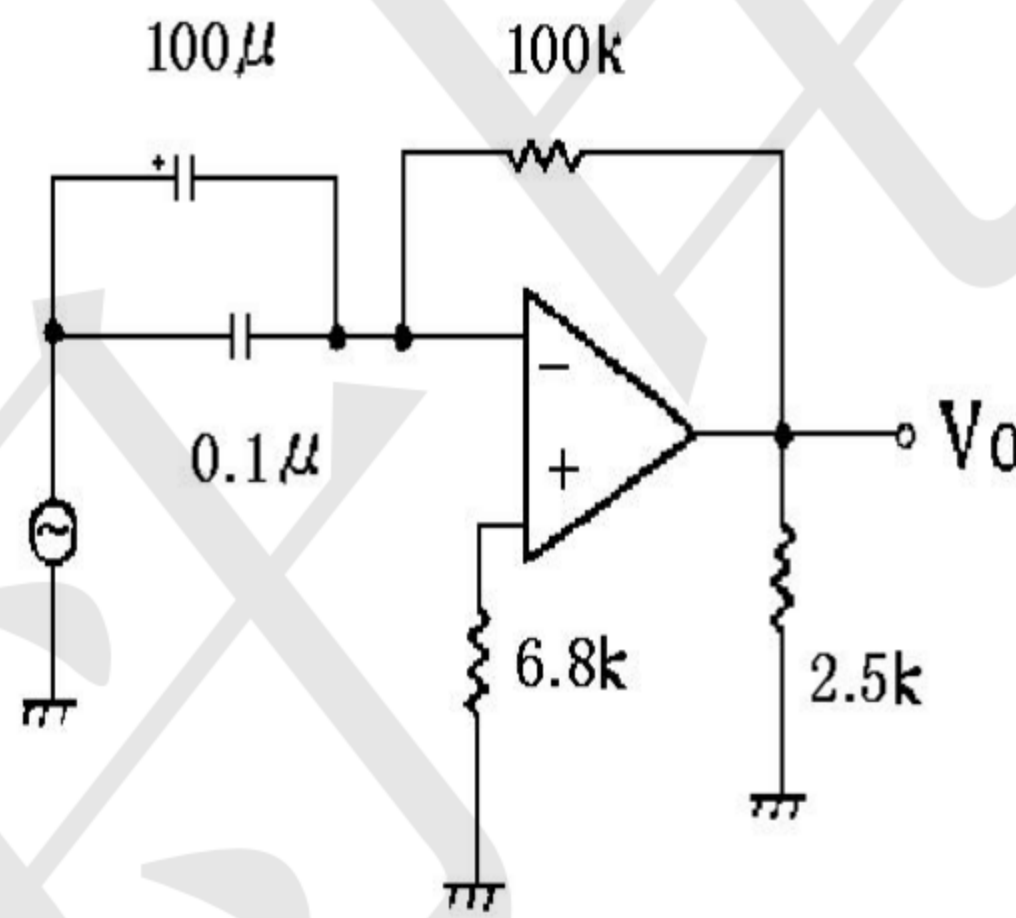

TYPICAL CHARACTERISTICS

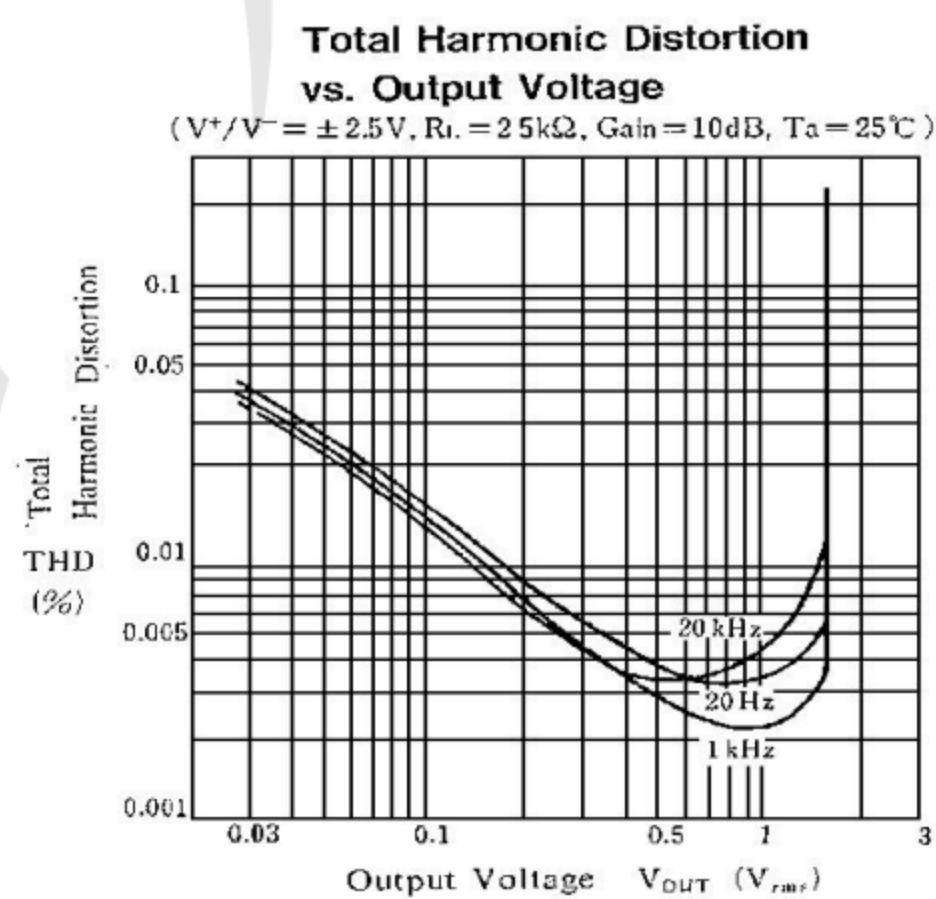

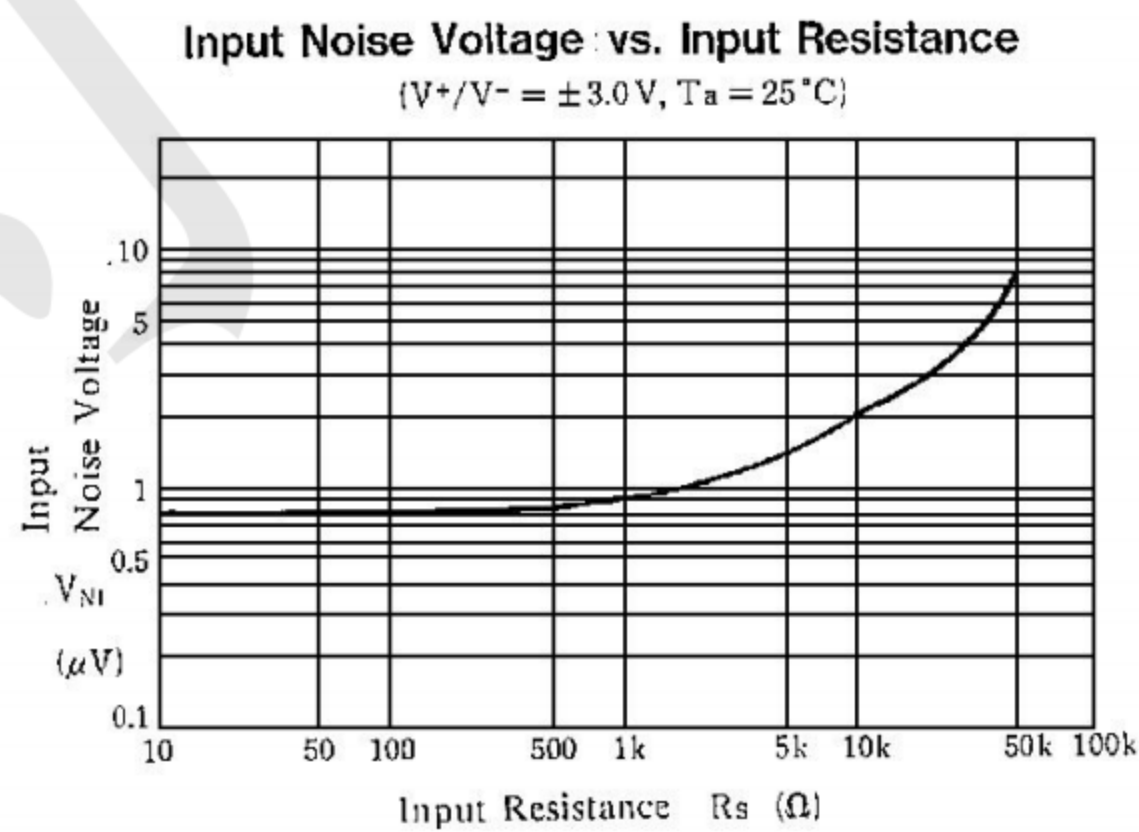
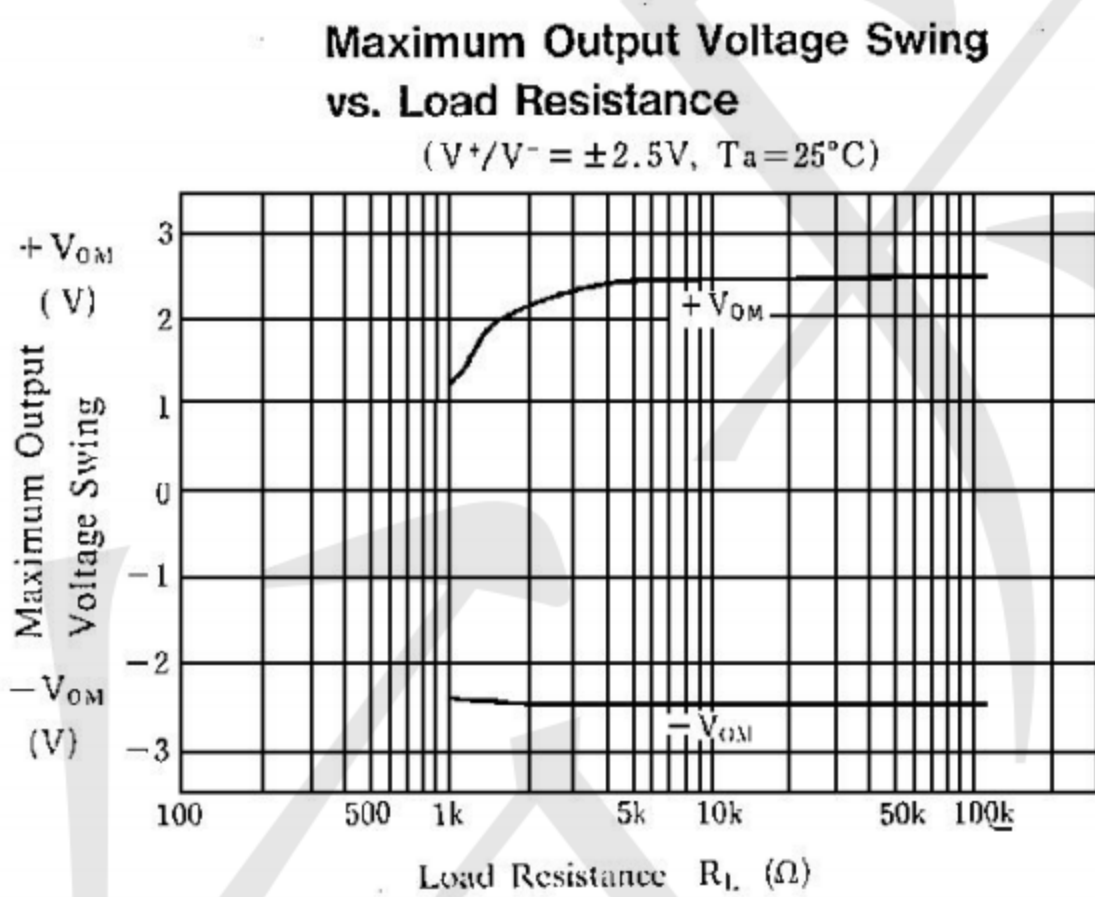
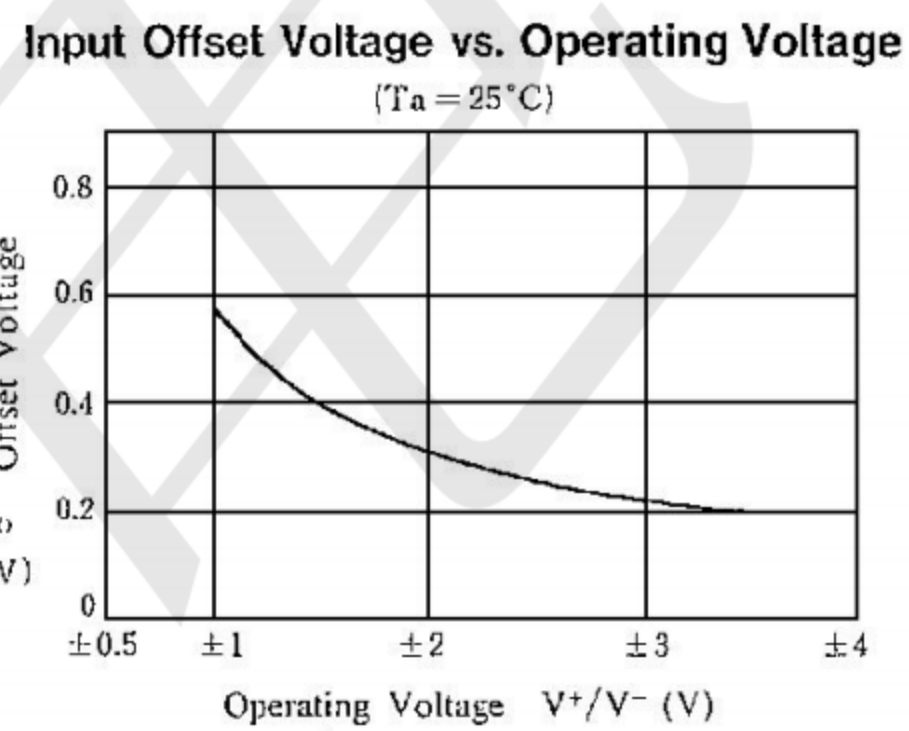
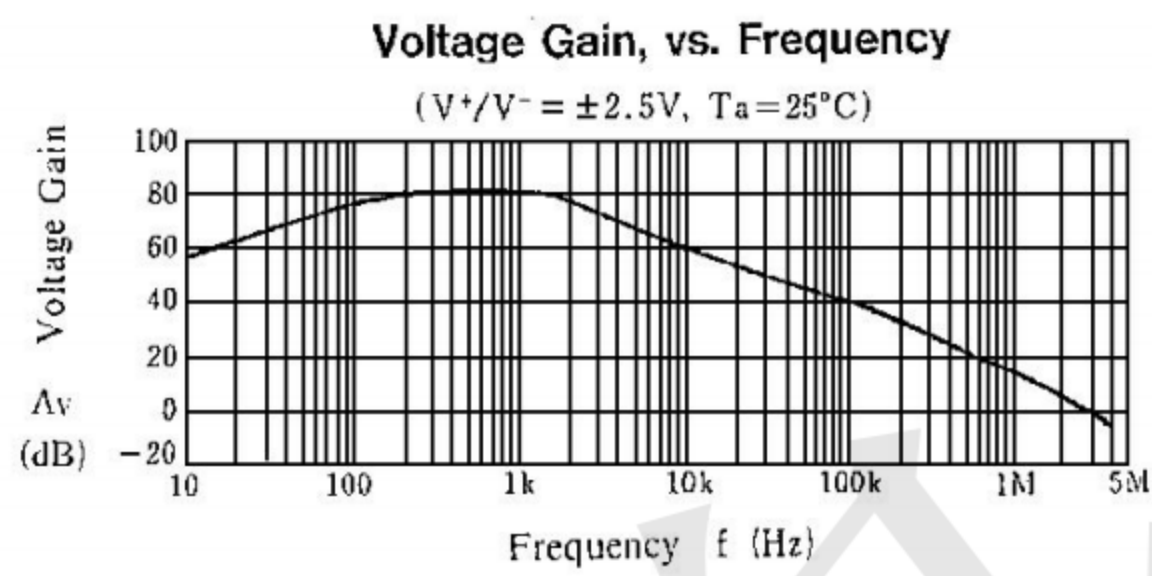
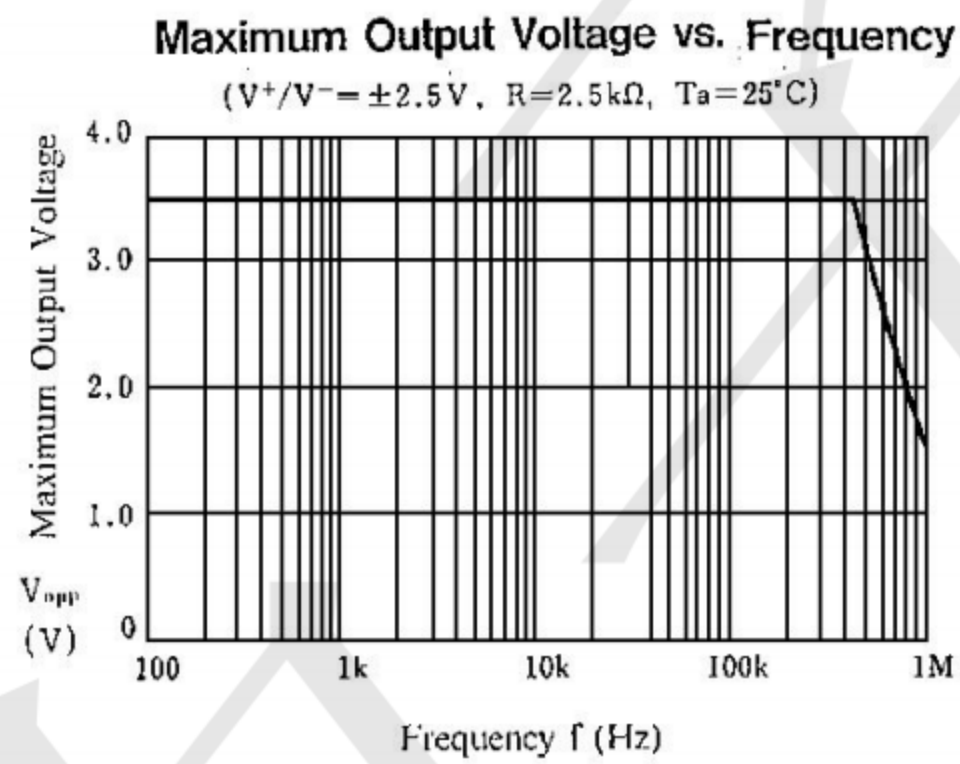
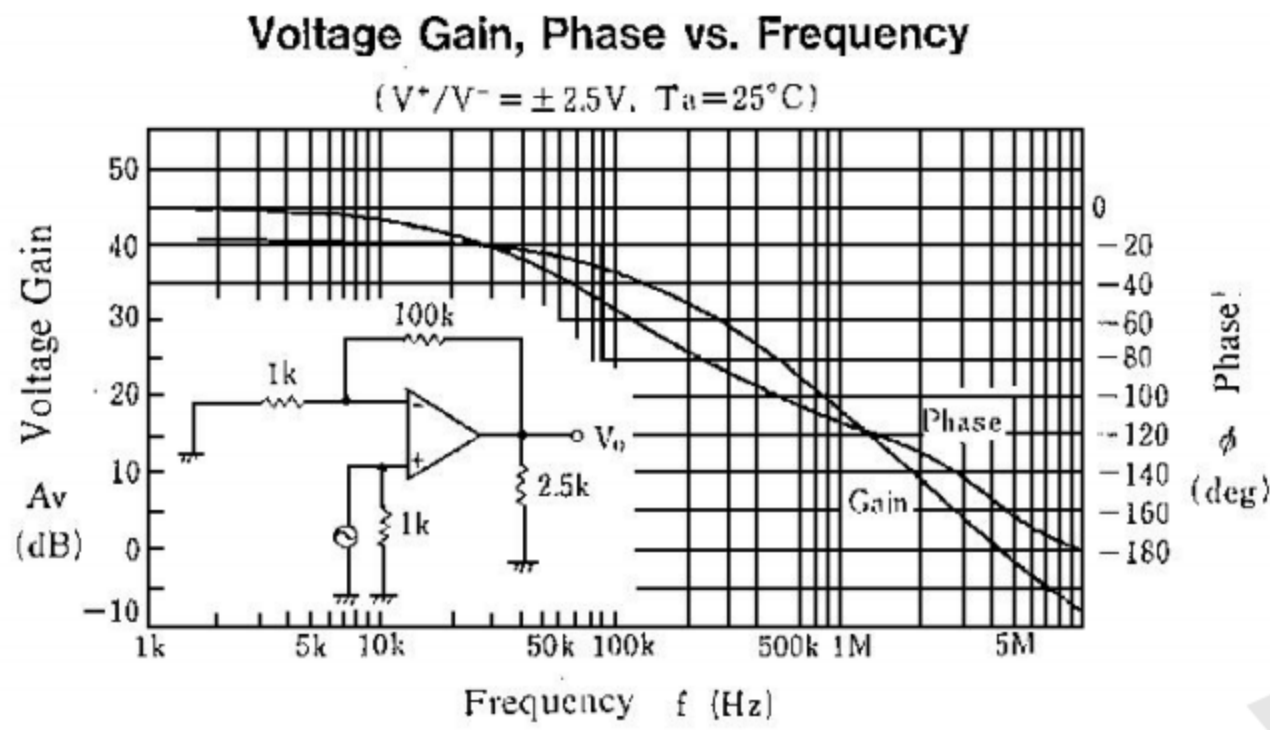



Operating Current vs. Temperature
($V^+/V^- = 2.5V$)

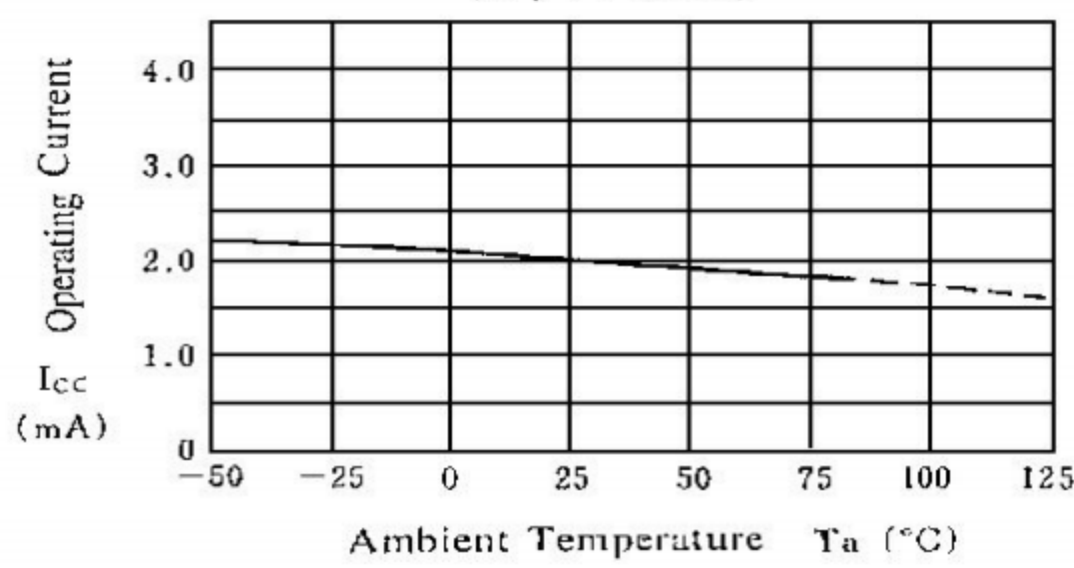

Maximum Output Voltage Swing vs. Temperature
($V^+/V^- = \pm 2.5V$)

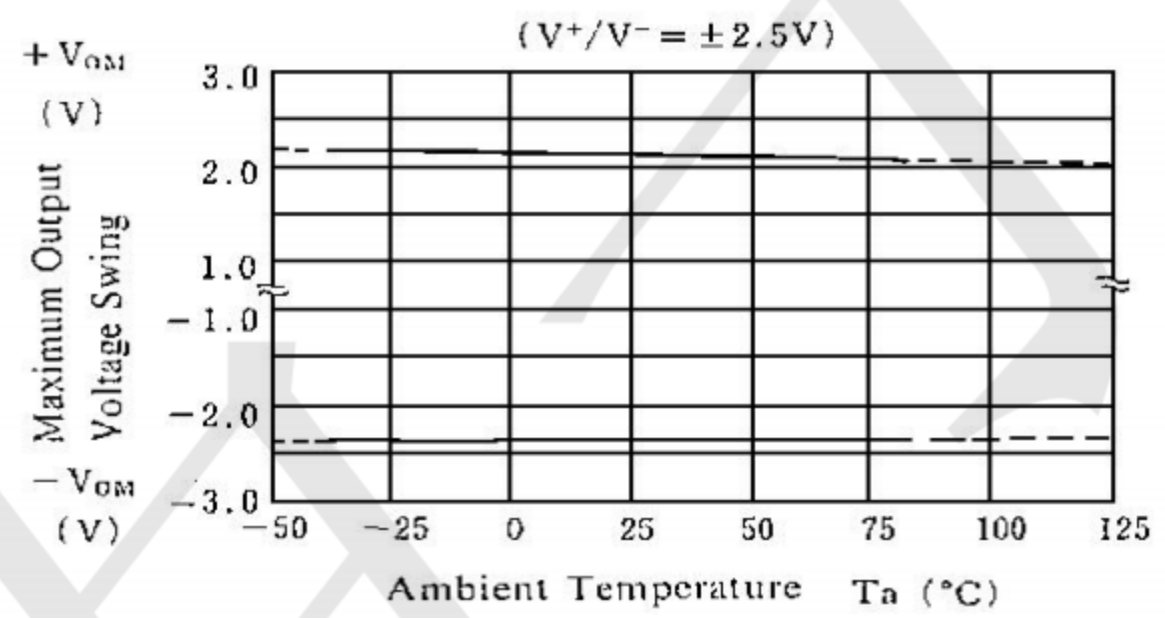

Input Offset Voltage vs. Temperature
($V^+/V^- = \pm 2.5V$)

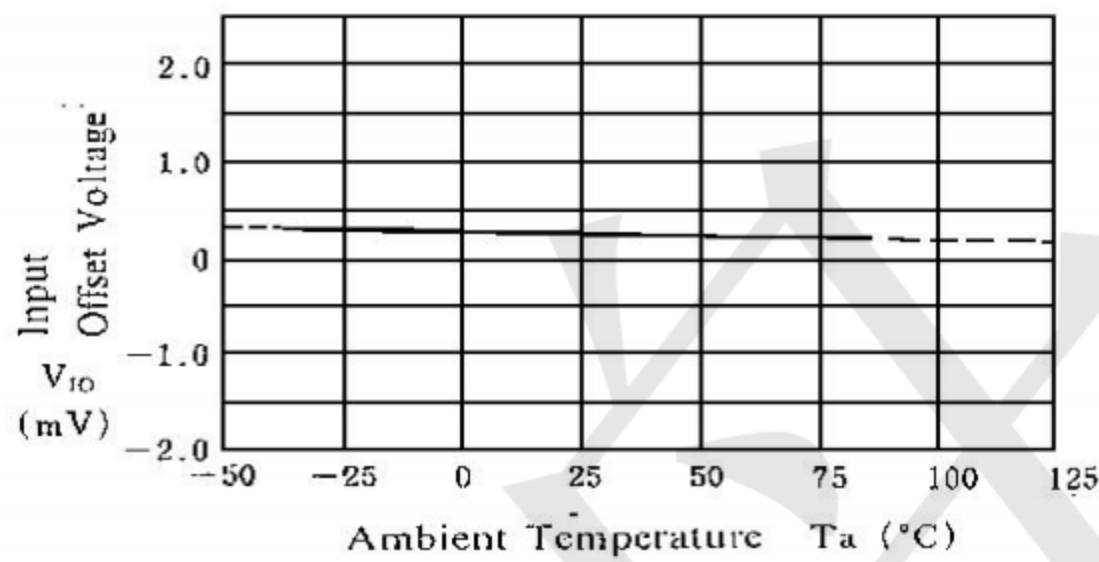

Input Bias Current vs. Temperature
($V^+/V^- = \pm 2.5V$)

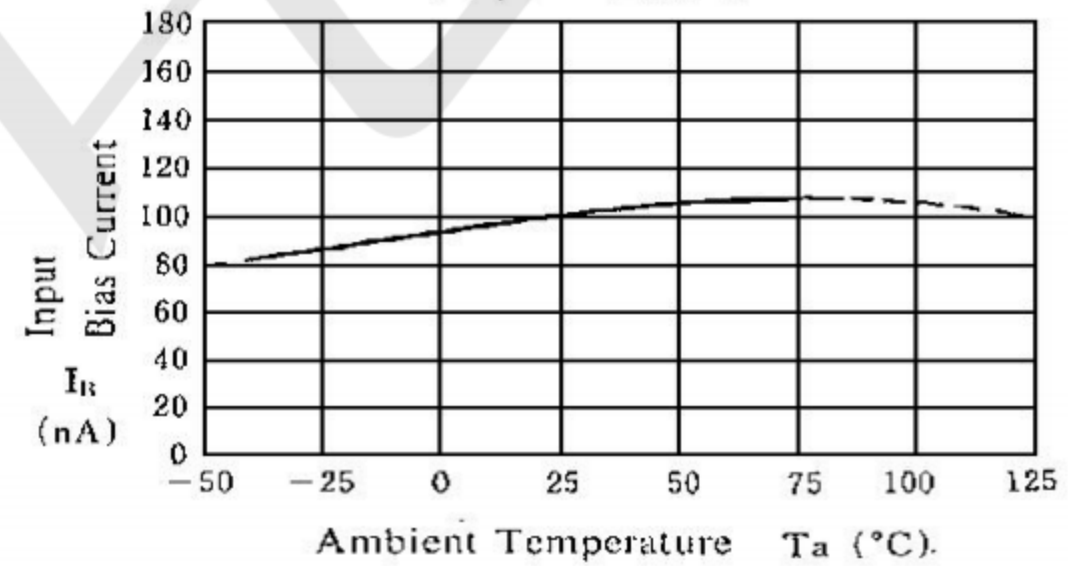

Operating Current vs. Operating Voltage
($T_a = 25^\circ C$)

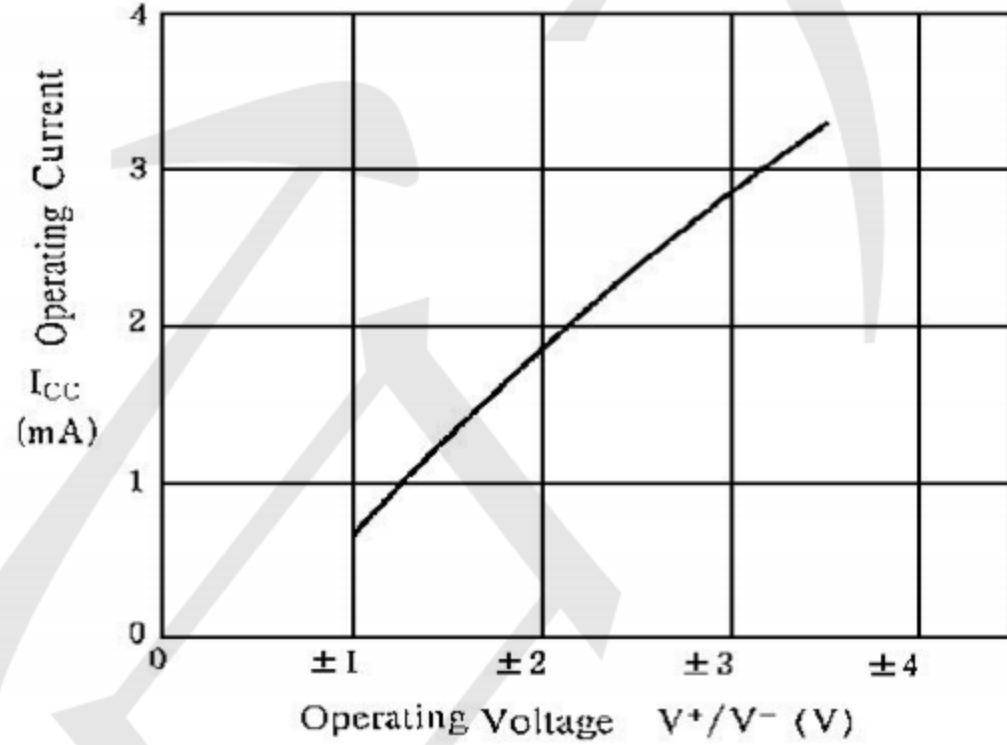

Maximum Output Voltage Swing vs. Operating Voltage
($R_L = 2.5 k\Omega, T_a = 25^\circ C$)

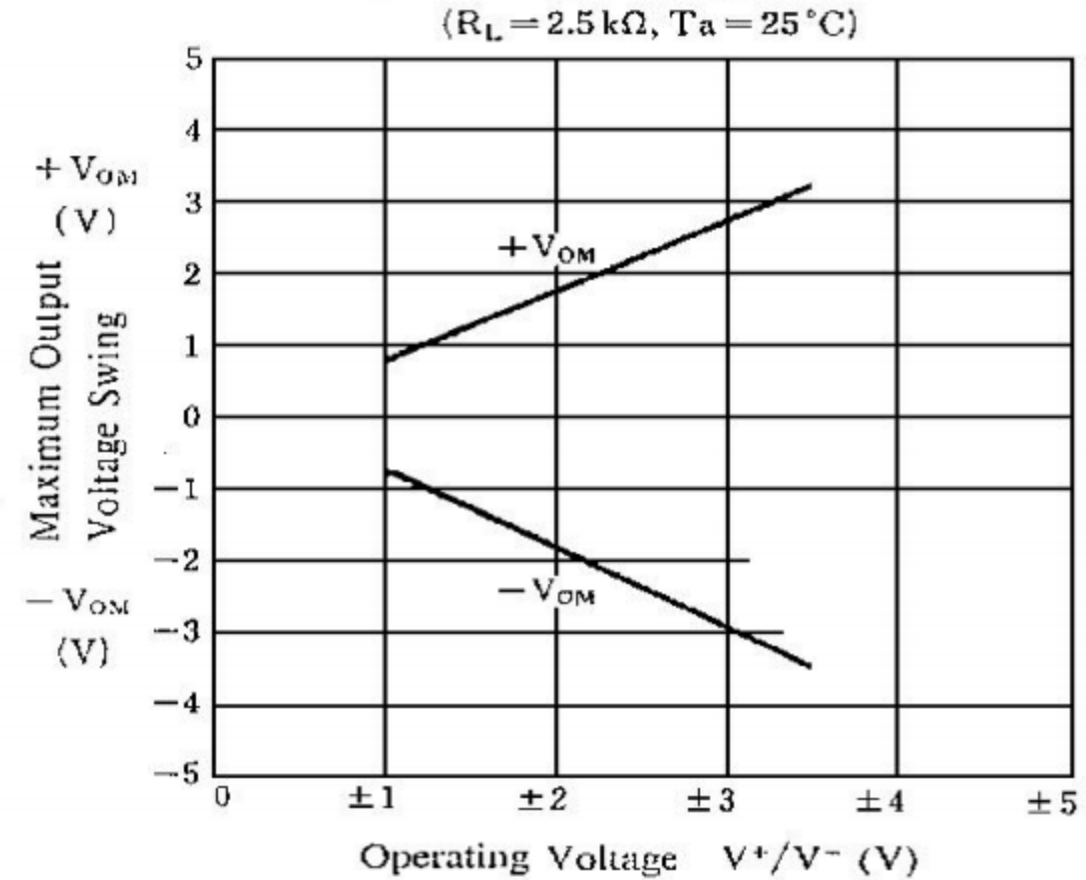



Package information

SOT-23-5L

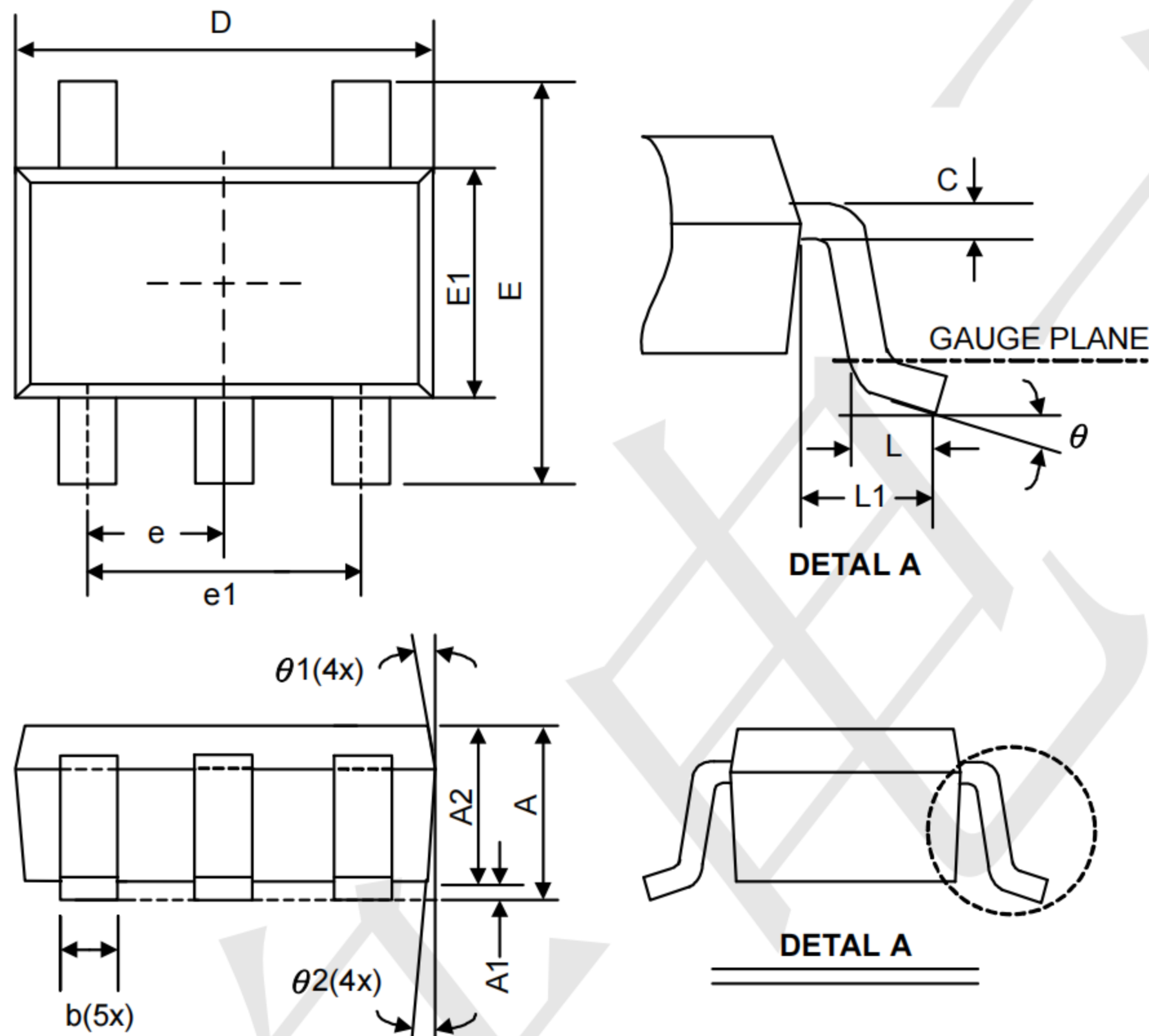

Symbol	Dimensions in Millimeters			Dimensions in Inches		
	Min.	Nom.	Max.	Min.	Nom.	Max.
A	-	-	1.45	-	-	0.057
A1	0	0.08	0.15	0	0.003	0.006
A2	0.9	1.1	1.3	0.035	0.043	0.051
b	0.3	0.4	0.5	0.012	0.016	0.02
C	0.08	0.15	0.22	0.003	0.006	0.009
D	2.7	2.9	3.1	0.106	0.114	0.122
E1	1.4	1.6	1.8	0.055	0.063	0.071
E	2.6	2.8	3	0.102	0.11	0.118
L	0.3	0.45	0.6	0.012	0.018	0.024
L1	0.5	0.6	0.7	0.02	0.024	0.028
e1	1.9 BSC			0.075 BSC		
e	0.95 BSC			0.037 BSC		
θ	0°	4°	8°	0°	4°	8°
$\theta 1$	5°	10°	15°	5°	10°	15°
$\theta 2$	5°	10°	15°	5°	10°	15°