

## TRANSISTOR(PNP)

### FEATURES

- Complementary to S9014

MARKING: M6

MAXIMUM RATINGS ( $T_A=25^{\circ}\text{C}$  unless otherwise noted)

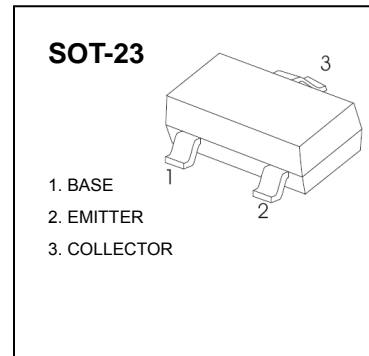

Symbol	Parameter	Value	Units
$V_{CB0}$	Collector-Base Voltage	-50	V
$V_{CE0}$	Collector-Emitter Voltage	-45	V
$V_{EBO}$	Emitter-Base Voltage	-5	V
$I_C$	Collector Current -Continuous	-0.1	A
$P_C$	Collector Power Dissipation	0.2	W
$T_j$	Junction Temperature	150	$^{\circ}\text{C}$
$T_{stg}$	Storage Temperature	-55-150	$^{\circ}\text{C}$

### ELECTRICAL CHARACTERISTICS ( $T_{amb}=25^{\circ}\text{C}$ unless otherwise specified)

Parameter	Symbol	Test conditions	MIN	TYP	MAX	UNIT
Collector-base breakdown voltage	$V_{(BR)CBO}$	$I_C = -100\mu\text{A}$ , $I_E = 0$	-50			V
Collector-emitter breakdown voltage	$V_{(BR)CEO}$	$I_C = -0.1\text{mA}$ , $I_B = 0$	-45			V
Emitter-base breakdown voltage	$V_{(BR)EBO}$	$I_E = -100\mu\text{A}$ , $I_C = 0$	-5			V
Collector cut-off current	$I_{CBO}$	$V_{CB} = -50\text{V}$ , $I_E = 0$			-0.1	$\mu\text{A}$
Emitter cut-off current	$I_{EBO}$	$V_{EB} = -5\text{V}$ , $I_C = 0$			-0.1	$\mu\text{A}$
DC current gain	$h_{FE}$	$V_{CE} = -5\text{V}$ , $I_C = -1\text{mA}$	200		1000	
Collector-emitter saturation voltage	$V_{CE(sat)}$	$I_C = -100\text{mA}$ , $I_B = -10\text{mA}$			-0.3	V
Base-emitter saturation voltage	$V_{BE(sat)}$	$I_C = -100\text{mA}$ , $I_B = -10\text{mA}$			-1	V
Transition frequency	$f_T$	$V_{CE} = -5\text{V}$ , $I_C = -10\text{mA}$ $f = 30\text{MHz}$	150			MHz

### CLASSIFICATION OF $h_{FE}$

Rank	L	H
Range	200-450	450-1000

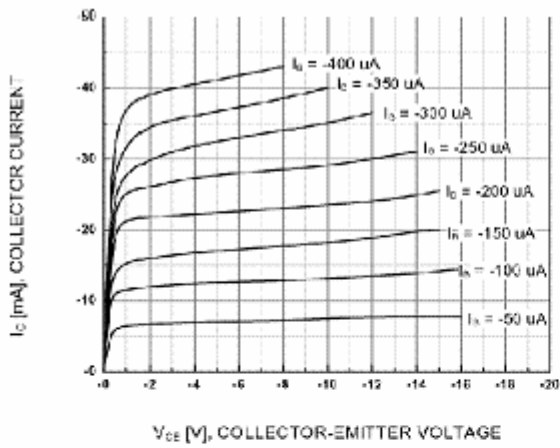

Figure 1. Static Characteristic

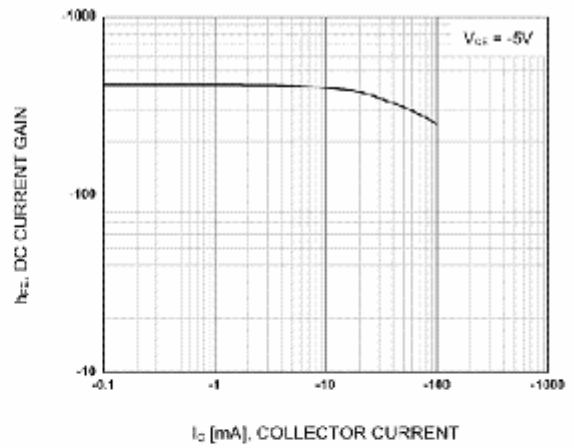

Figure 2. DC current Gain

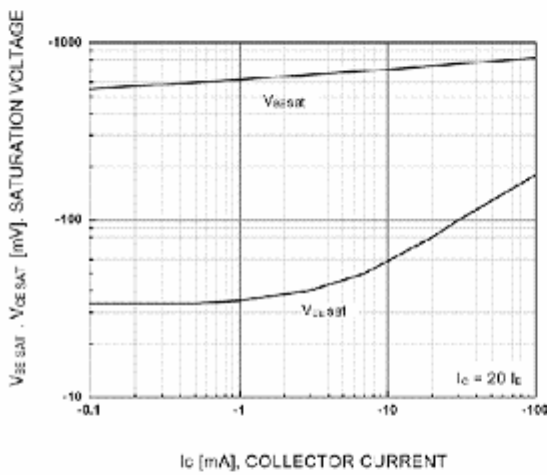

Figure 3. Base-Emitter Saturation Voltage  
Collector-Emitter Saturation Voltage

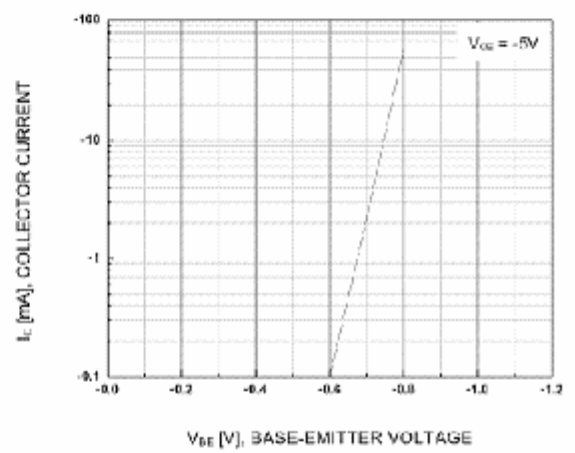

Figure 4. Base-Emitter On Voltage

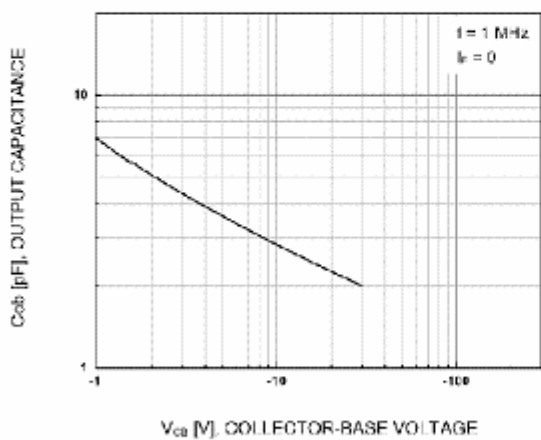

Figure 5. Collector Output Capacitance

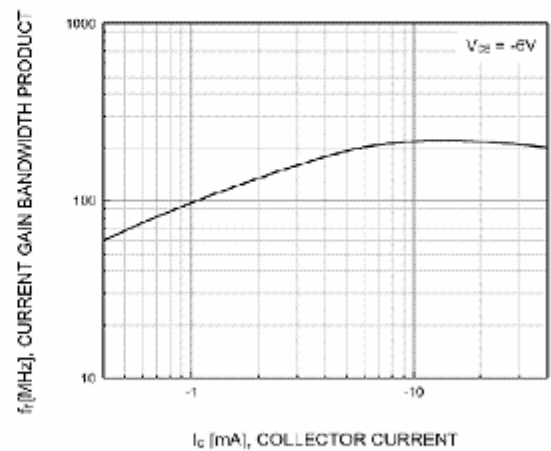

Figure 6. Current Gain Bandwidth Product