



V_{DS}	1000 V
$I_D @ 25^\circ C$	32 A
$R_{DS(on)}$	65 m Ω

Features

- Optimized package with separate driver source pin
- High blocking voltage with low on-resistance
- High-speed switching with low capacitances
- Fast intrinsic diode with low reverse recovery (Q_{rr})
- Halogen free, RoHS compliant

Benefits

- Reduce switching losses and minimize gate ringing
- Higher system efficiency
- Reduce cooling requirements
- Increase power density
- Increase system switching frequency

Applications

- Renewable energy
- EV battery chargers
- High voltage DC/DC converters
- Switch Mode Power Supplies

Part Number	Package
GC3M0065100K	TO-247-4



TO-247-4
Package

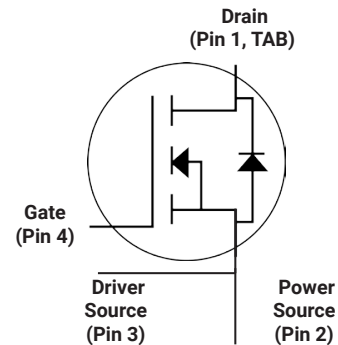

Maximum Ratings ($T_C = 25^\circ C$ unless otherwise specified)

Symbol	Parameter	Value	Unit	Test Conditions	Note
V_{DSmax}	Drain - Source Voltage	1000	V	$V_{GS} = 0 V, I_D = 100 \mu A$	
V_{GSmax}	Gate - Source Voltage (dynamic)	-8/+19	V	AC ($f > 1 Hz$)	Note: 1
V_{GSop}	Gate - Source Voltage (static)	-4/+15	V	Static	Note: 2
I_D	Continuous Drain Current	32	A	$V_{GS} = 15 V, T_C = 25^\circ C$	Fig. 19
		21		$V_{GS} = 15 V, T_C = 100^\circ C$	
$I_{D(pulse)}$	Pulsed Drain Current	90	A	Pulse width t_p limited by T_{jmax}	Fig. 22
E_{AS}	Avalanche energy, Single pulse	110	mJ	$I_D = 22A, V_{DD} = 50V$	
P_D	Power Dissipation	113.5	W	$T_C = 25^\circ C, T_J = 150^\circ C$	Fig. 20
T_J, T_{stg}	Operating Junction and Storage Temperature	-55 to +150	$^\circ C$		
T_L	Solder Temperature	260	$^\circ C$	1.6mm (0.063") from case for 10s	

Note (1): When using MOSFET Body Diode $V_{GSmax} = -4V/+19V$

Note (2): MOSFET can also safely operate at 0/+15 V

Electrical Characteristics ($T_C = 25^\circ\text{C}$ unless otherwise specified)

Symbol	Parameter	Min.	Typ.	Max.	Unit	Test Conditions	Note
$V_{(BR)DSS}$	Drain-Source Breakdown Voltage	1000			V	$V_{GS} = 0\text{ V}, I_D = 100\ \mu\text{A}$	
$V_{GS(th)}$	Gate Threshold Voltage	1.8	2.1	3.5	V	$V_{DS} = V_{GS}, I_D = 5\ \text{mA}$	Fig. 11
			1.6		V	$V_{DS} = V_{GS}, I_D = 5\ \text{mA}, T_J = 150^\circ\text{C}$	
I_{DSS}	Zero Gate Voltage Drain Current		1	100	μA	$V_{DS} = 1000\ \text{V}, V_{GS} = 0\ \text{V}$	
I_{GSS}	Gate-Source Leakage Current		10	250	nA	$V_{GS} = 15\ \text{V}, V_{DS} = 0\ \text{V}$	
$R_{DS(on)}$	Drain-Source On-State Resistance		65	78	m Ω	$V_{GS} = 15\ \text{V}, I_D = 20\ \text{A}$	Fig. 4, 5, 6
			95			$V_{GS} = 15\ \text{V}, I_D = 20\ \text{A}, T_J = 150^\circ\text{C}$	
g_{fs}	Transconductance		14		S	$V_{DS} = 20\ \text{V}, I_{DS} = 20\ \text{A}$	Fig. 7
			12			$V_{DS} = 20\ \text{V}, I_{DS} = 20\ \text{A}, T_J = 150^\circ\text{C}$	
C_{iss}	Input Capacitance		760		pF	$V_{GS} = 0\ \text{V}, V_{DS} = 600\ \text{V}$ $f = 1\ \text{MHz}$ $V_{AC} = 25\ \text{mV}$	Fig. 17, 18
C_{oss}	Output Capacitance		70				
C_{rss}	Reverse Transfer Capacitance		5				
E_{oss}	C_{oss} Stored Energy		15				μJ
E_{ON}	Turn-On Switching Energy (Body Diode FWD)		127		μJ	$V_{DS} = 700\ \text{V}, V_{GS} = -4\ \text{V}/15\ \text{V}, I_D = 20\ \text{A},$ $R_{G(ext)} = 2.5\ \Omega, L = 130\ \mu\text{H}, T_J = 150^\circ\text{C}$	Fig. 26
E_{OFF}	Turn Off Switching Energy (Body Diode FWD)		36				
$t_{d(on)}$	Turn-On Delay Time		7		ns	$V_{DD} = 700\ \text{V}, V_{GS} = -4\ \text{V}/15\ \text{V}$ $I_D = 20\ \text{A}, R_{G(ext)} = 2.5\ \Omega,$ Timing relative to V_{DS} Inductive load	Fig. 27
t_r	Rise Time		9				
$t_{d(off)}$	Turn-Off Delay Time		13				
t_f	Fall Time		7				
$R_{G(int)}$	Internal Gate Resistance		3.5		Ω	$f = 1\ \text{MHz}, V_{AC} = 25\ \text{mV}$	
Q_{gs}	Gate to Source Charge		9		nC	$V_{DS} = 700\ \text{V}, V_{GS} = -4\ \text{V}/15\ \text{V}$ $I_D = 20\ \text{A}$ Per IEC60747-8-4 pg 21	Fig. 12
Q_{gd}	Gate to Drain Charge		16				
Q_g	Total Gate Charge		37				

Reverse Diode Characteristics ($T_C = 25^\circ\text{C}$ unless otherwise specified)

Symbol	Parameter	Typ.	Max.	Unit	Test Conditions	Note
V_{SD}	Diode Forward Voltage	4.5		V	$V_{GS} = -4\ \text{V}, I_{SD} = 10\ \text{A}$	Fig. 8, 9, 10
		4.2		V	$V_{GS} = -4\ \text{V}, I_{SD} = 10\ \text{A}, T_J = 150^\circ\text{C}$	
I_S	Continuous Diode Forward Current		22	A	$V_{GS} = -4\ \text{V}$	Note 1
$I_{S,pulse}$	Diode pulse Current		90	A	$V_{GS} = -4\ \text{V}$, pulse width t_p limited by T_{jmax}	Note 1
t_{rr}	Reverse Recover time	18		ns	$V_{GS} = -4\ \text{V}, I_{SD} = 20\ \text{A}, V_R = 700\ \text{V}$ $\text{dif}/\text{dt} = 4500\ \text{A}/\mu\text{s}, T_J = 150^\circ\text{C}$	Note 1
Q_{rr}	Reverse Recovery Charge	251		nC		
I_{rrm}	Peak Reverse Recovery Current	24		A		

Thermal Characteristics

Symbol	Parameter	Typ.	Max.	Unit	Test Conditions	Note
$R_{\theta JC}$	Thermal Resistance from Junction to Case	0.94	1.1	$^\circ\text{C}/\text{W}$		Fig. 21
$R_{\theta JA}$	Thermal Resistance From Junction to Ambient		40			

Typical Performance

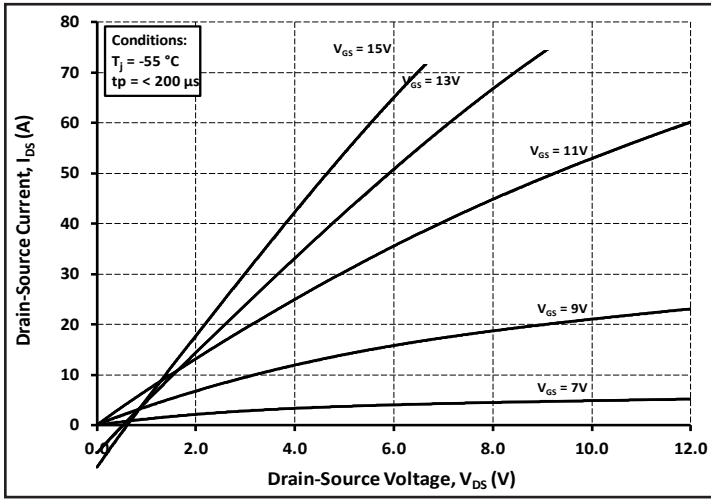

Figure 1. Output Characteristics $T_J = -55\text{ }^\circ\text{C}$

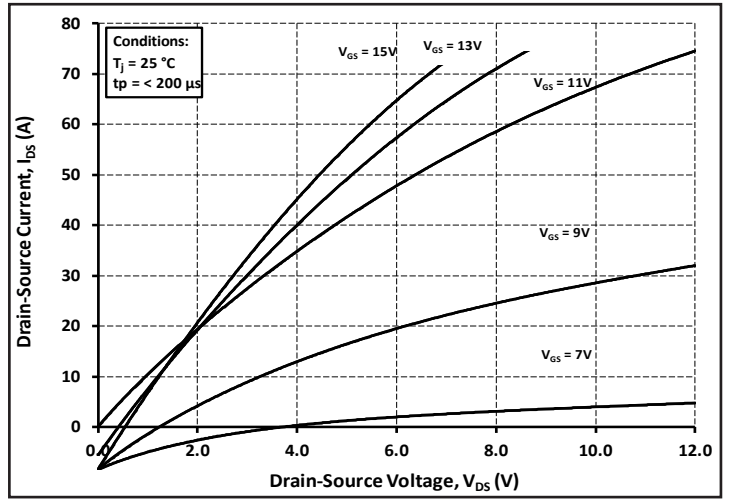

Figure 2. Output Characteristics $T_J = 25\text{ }^\circ\text{C}$

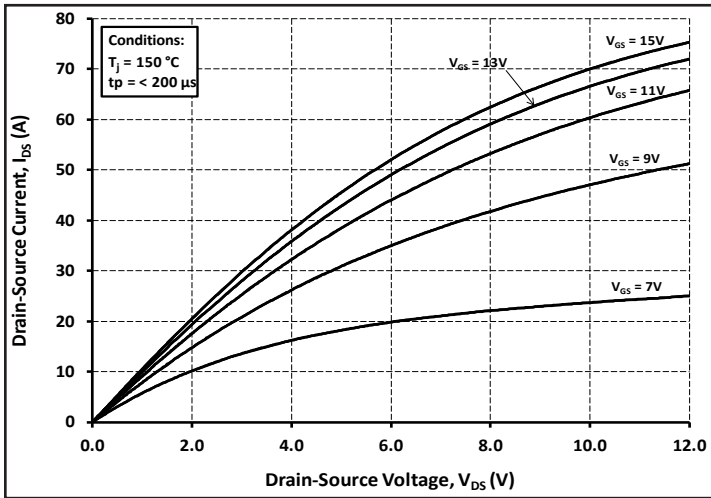

Figure 3. Output Characteristics $T_J = 150\text{ }^\circ\text{C}$

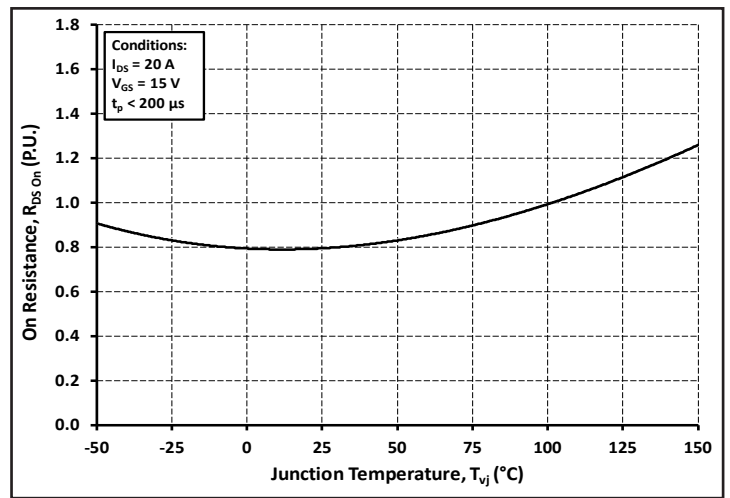

Figure 4. Normalized On-Resistance vs. Temperature

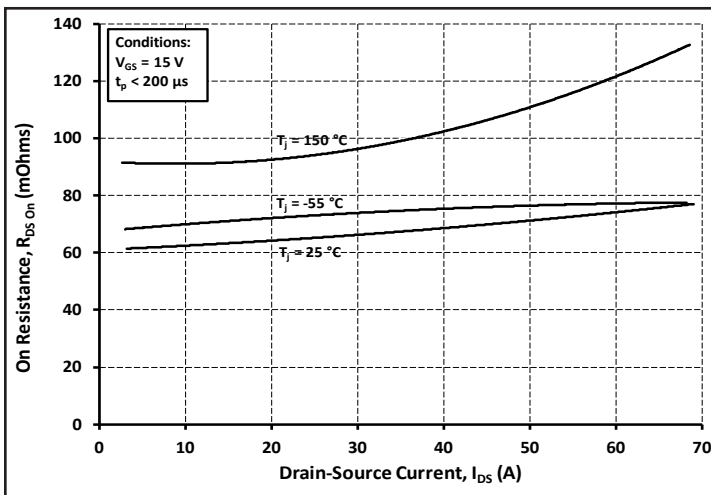

Figure 5. On-Resistance vs. Drain Current For Various Temperatures

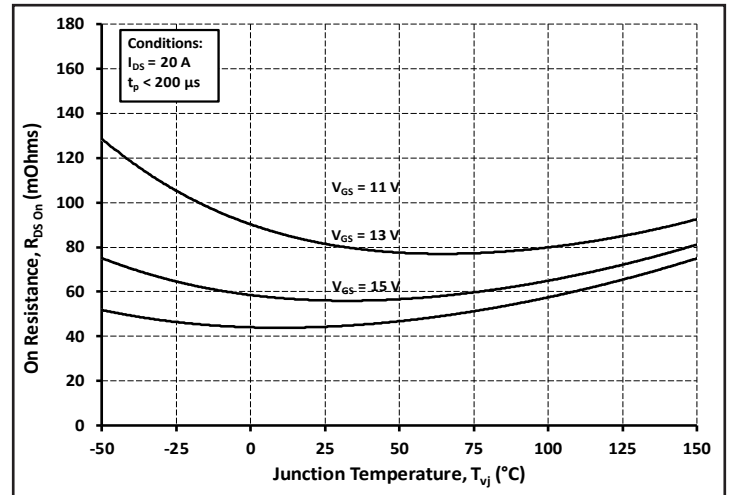

Figure 6. On-Resistance vs. Temperature For Various Gate Voltage

Typical Performance

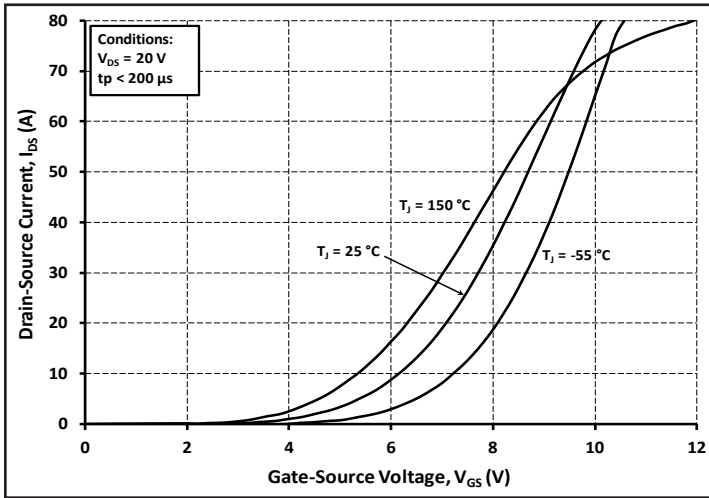

Figure 7. Transfer Characteristic for Various Junction Temperatures

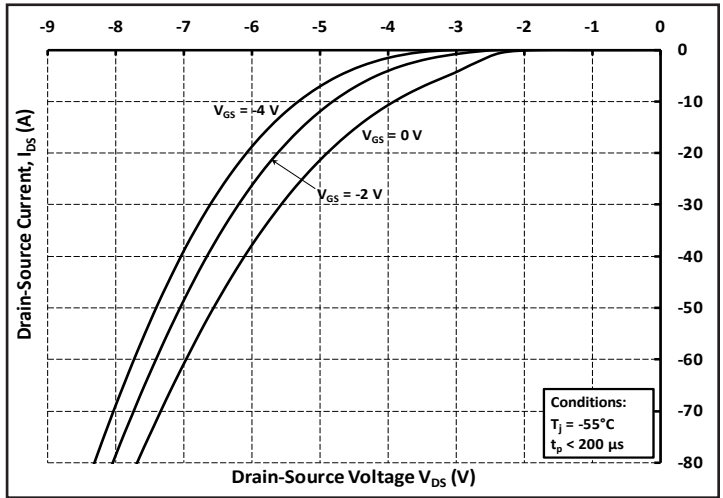

Figure 8. Body Diode Characteristic at -55 °C

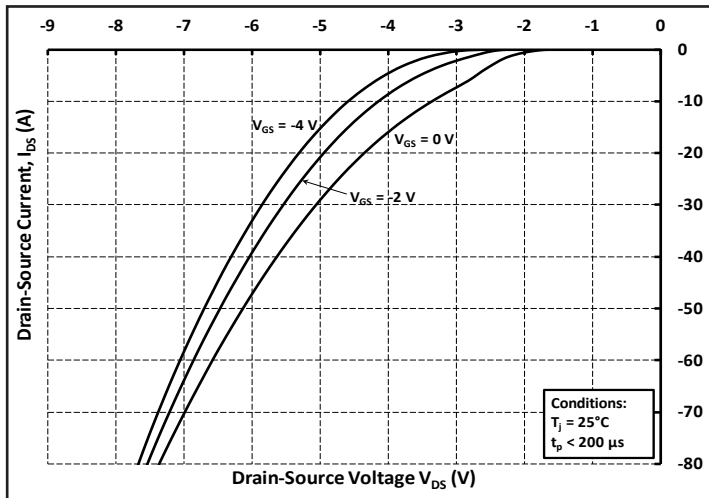

Figure 9. Body Diode Characteristic at 25 °C

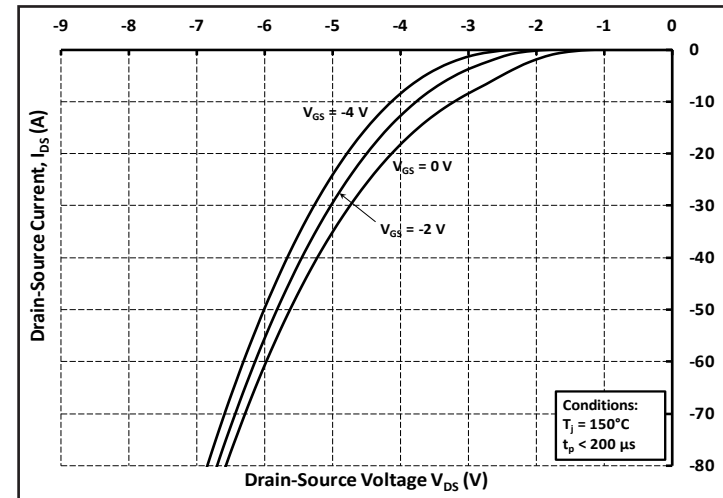

Figure 10. Body Diode Characteristic at 150 °C

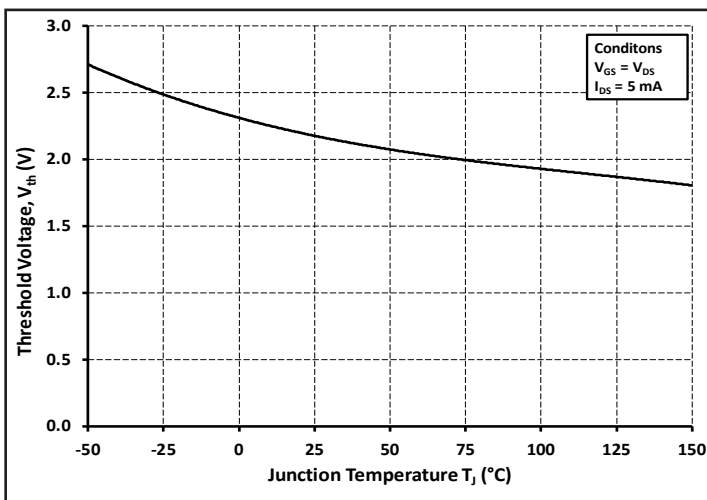

Figure 11. Threshold Voltage vs. Temperature

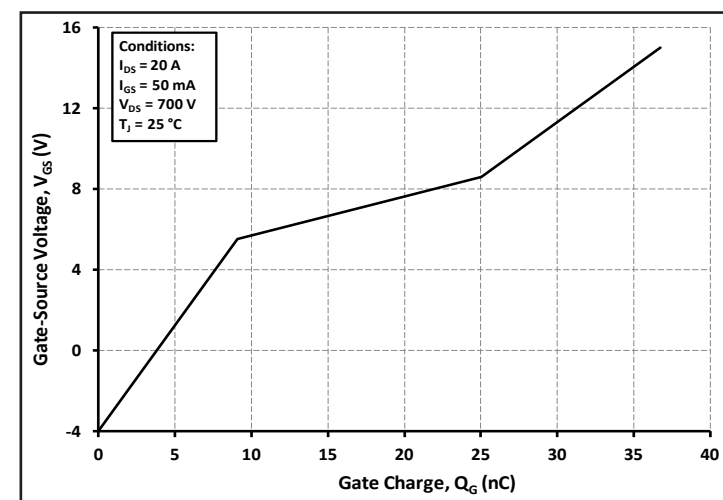

Figure 12. Gate Charge Characteristics

Typical Performance

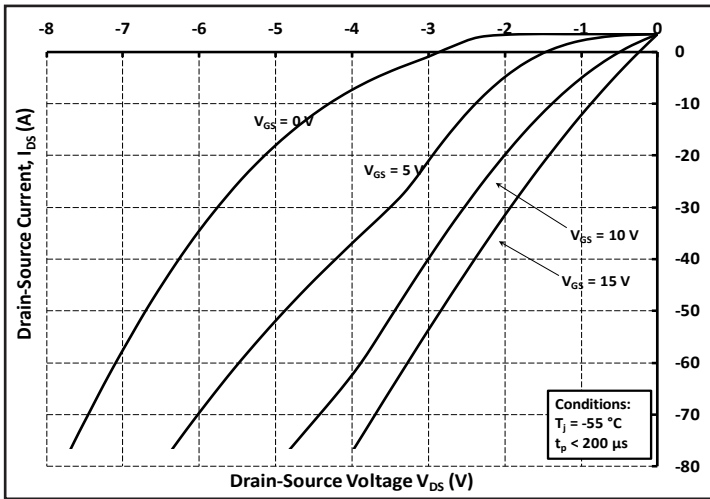

Figure 13. 3rd Quadrant Characteristic at -55 °C

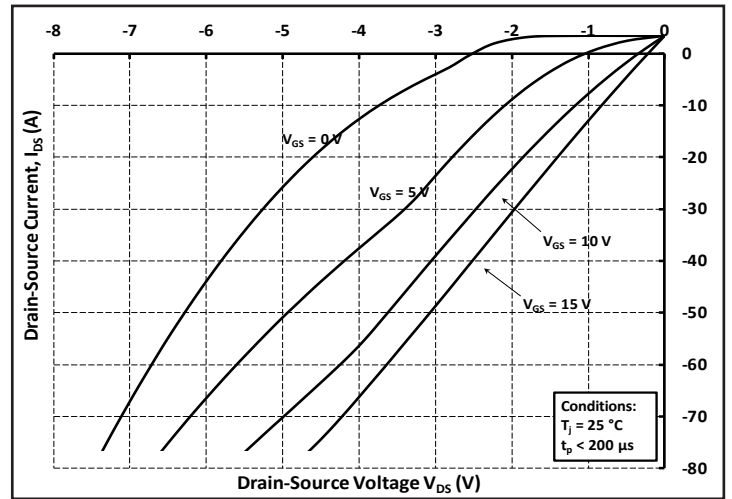

Figure 14. 3rd Quadrant Characteristic at 25 °C

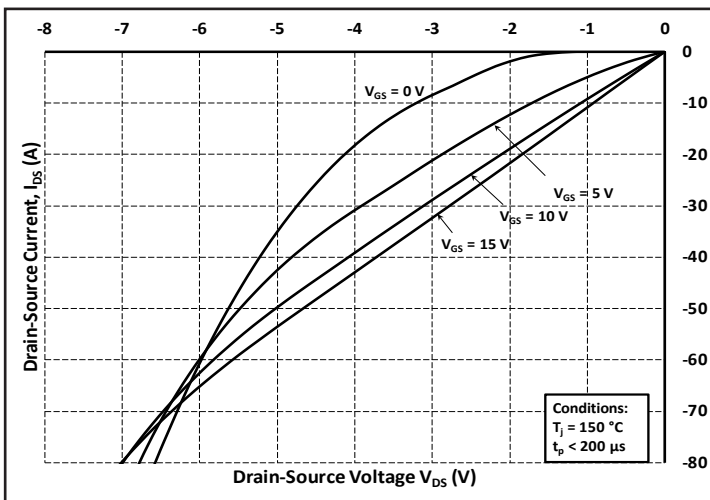

Figure 15. 3rd Quadrant Characteristic at 150 °C

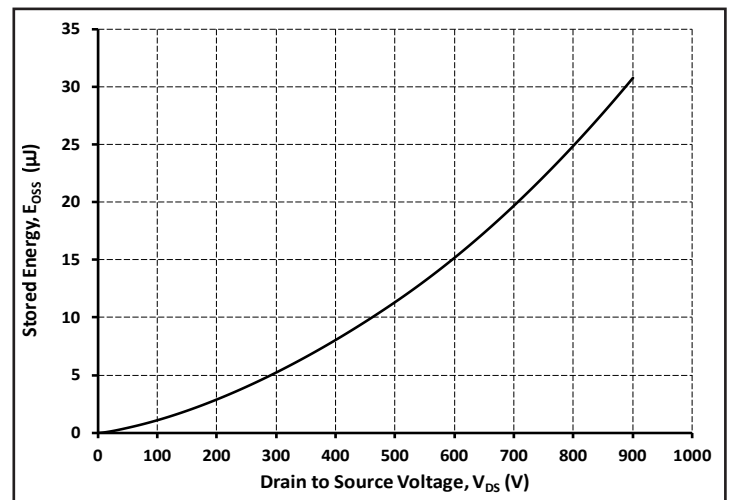

Figure 16. Output Capacitor Stored Energy

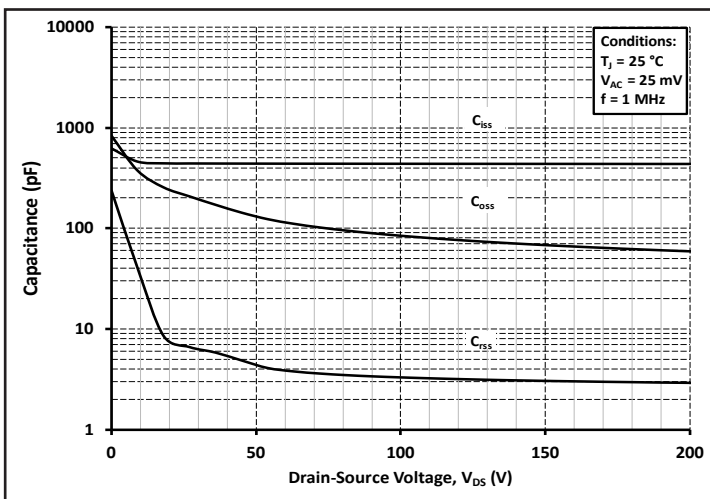

Figure 17. Capacitances vs. Drain-Source Voltage (0 - 200V)

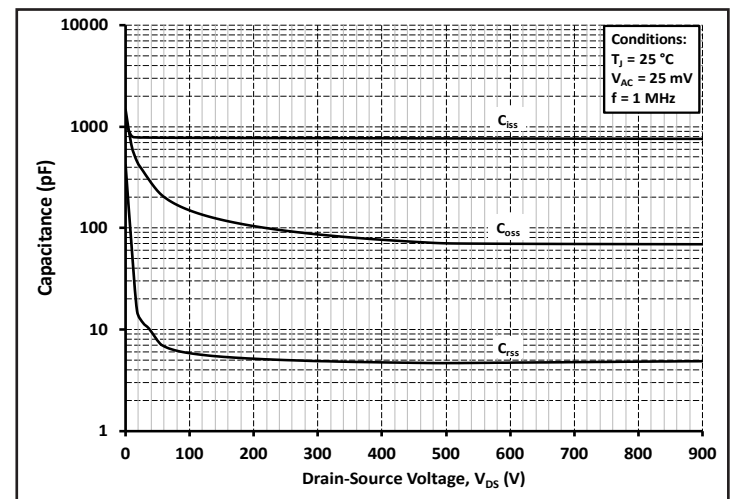

Figure 18. Capacitances vs. Drain-Source Voltage (0 - 1000V)

Typical Performance

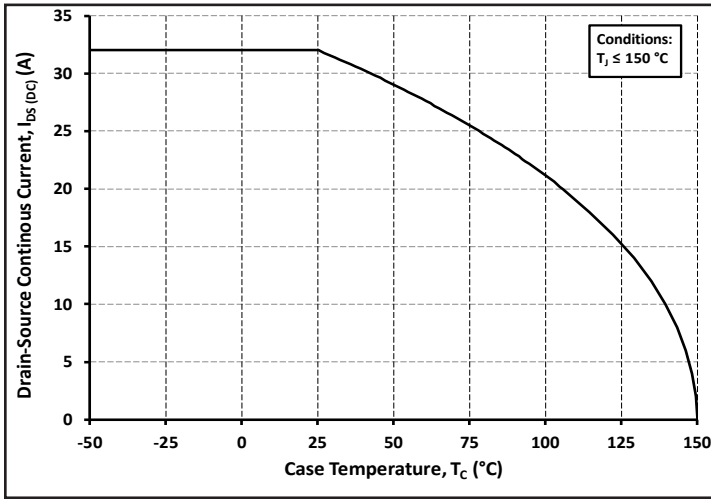

Figure 19. Continuous Drain Current Derating vs. Case Temperature

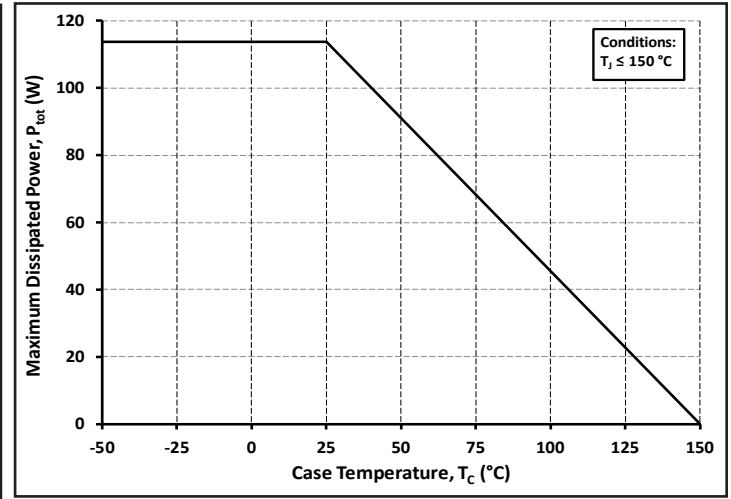

Figure 20. Maximum Power Dissipation Derating vs. Case Temperature

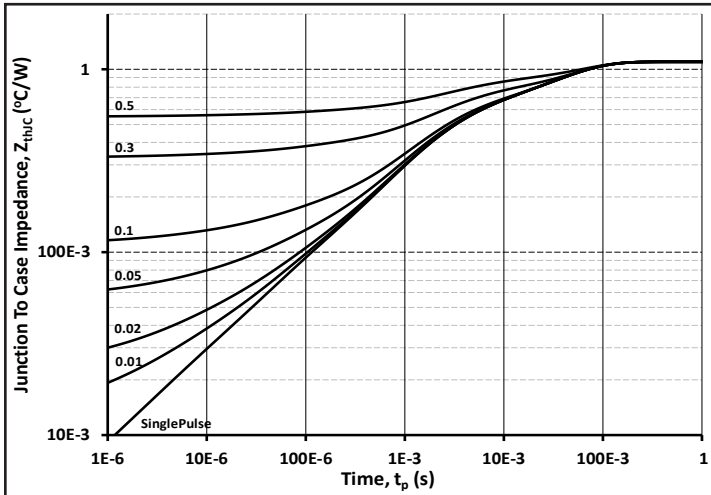

Figure 21. Transient Thermal Impedance (Junction - Case)

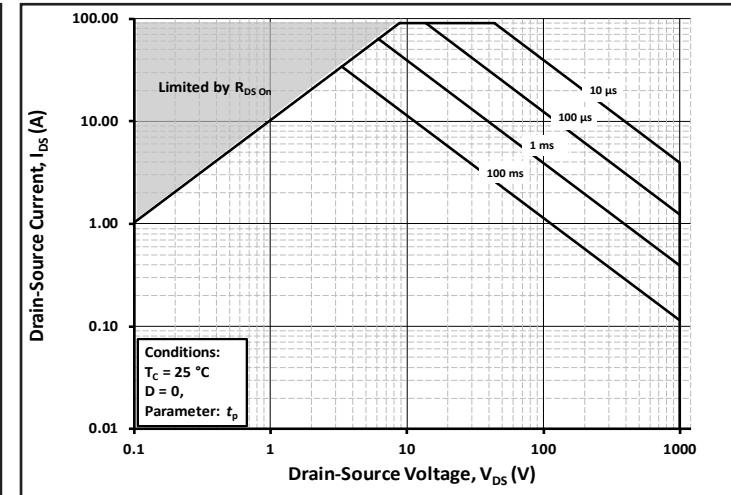

Figure 22. Safe Operating Area

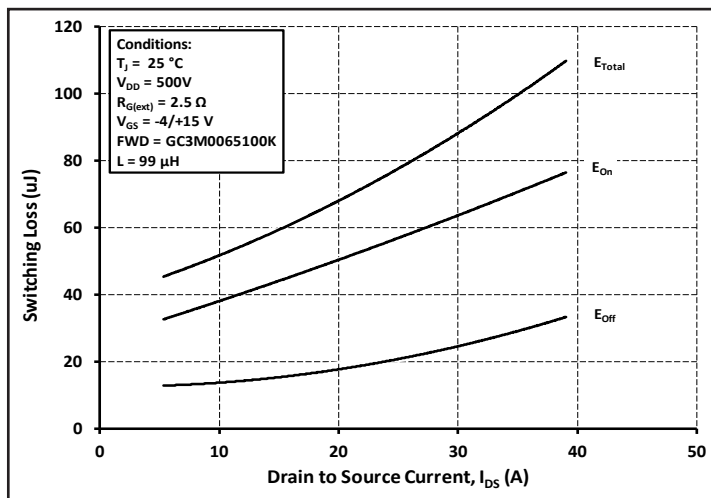

Figure 23. Clamped Inductive Switching Energy vs. Drain Current ($V_{DD} = 500V$)

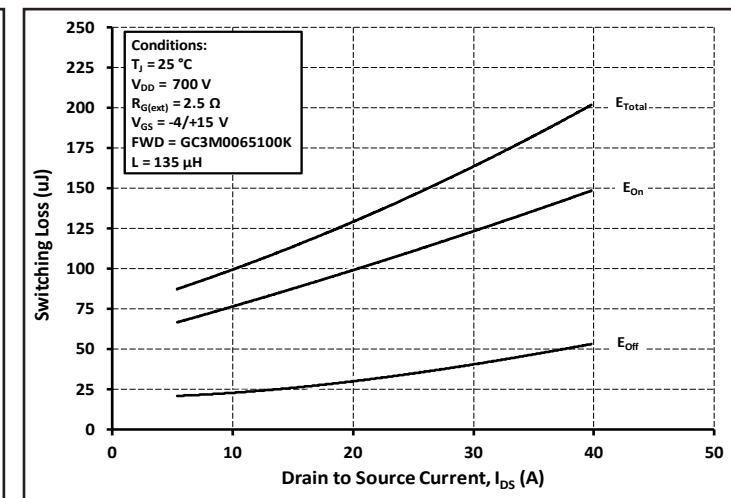

Figure 24. Clamped Inductive Switching Energy vs. Drain Current ($V_{DD} = 700V$)

Typical Performance

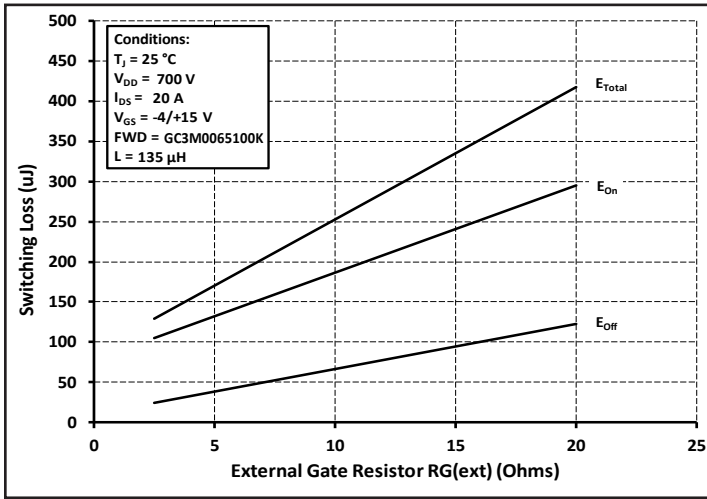

Figure 25. Clamped Inductive Switching Energy vs. $R_{G(ext)}$

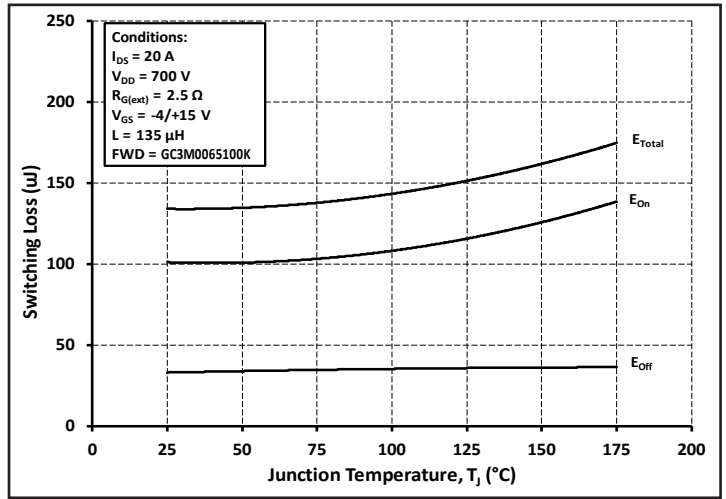

Figure 26. Clamped Inductive Switching Energy vs. Temperature

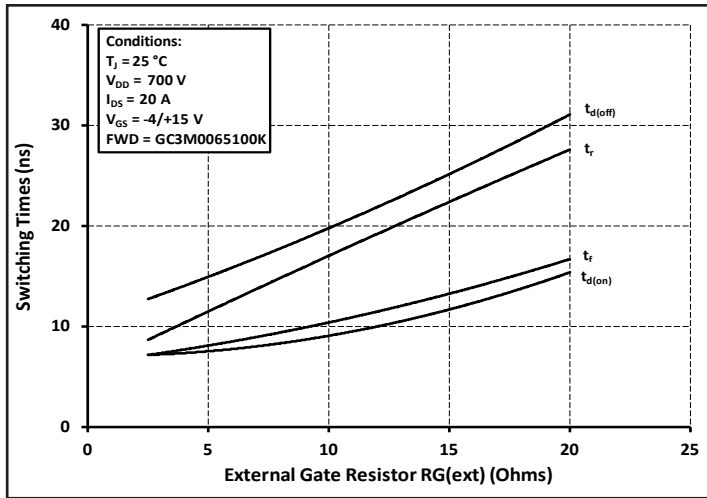

Figure 27. Switching Times vs. $R_{G(ext)}$

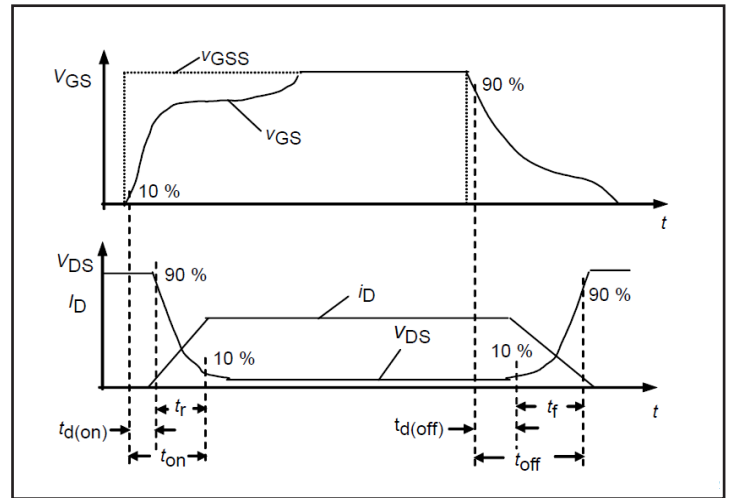

Figure 28. Switching Times Definition

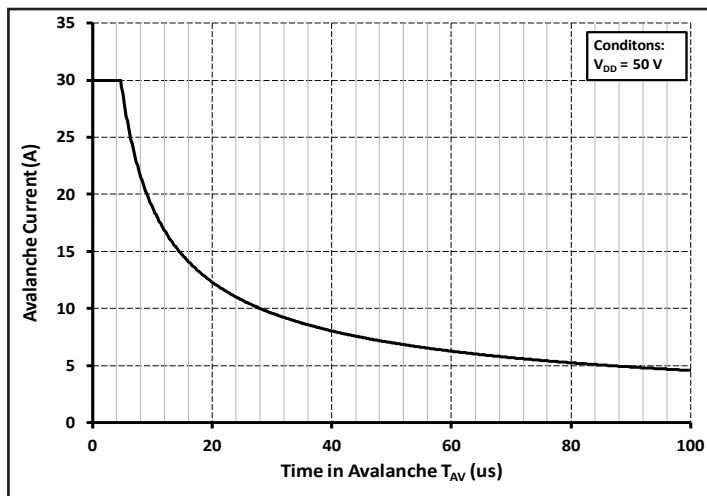

Figure 29. Single Avalanche SOA curve

Test Circuit Schematic

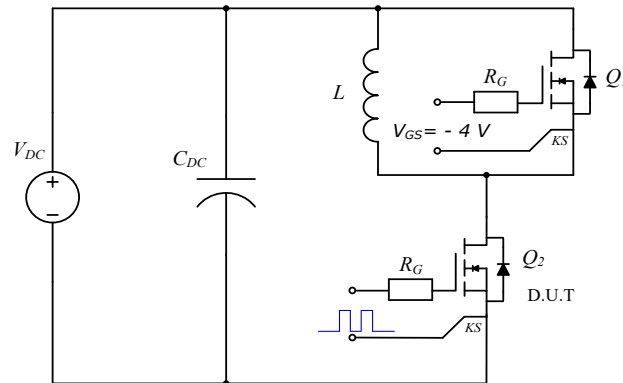
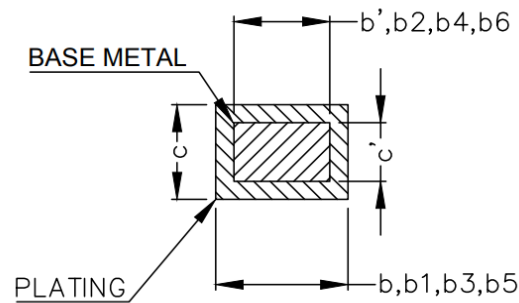
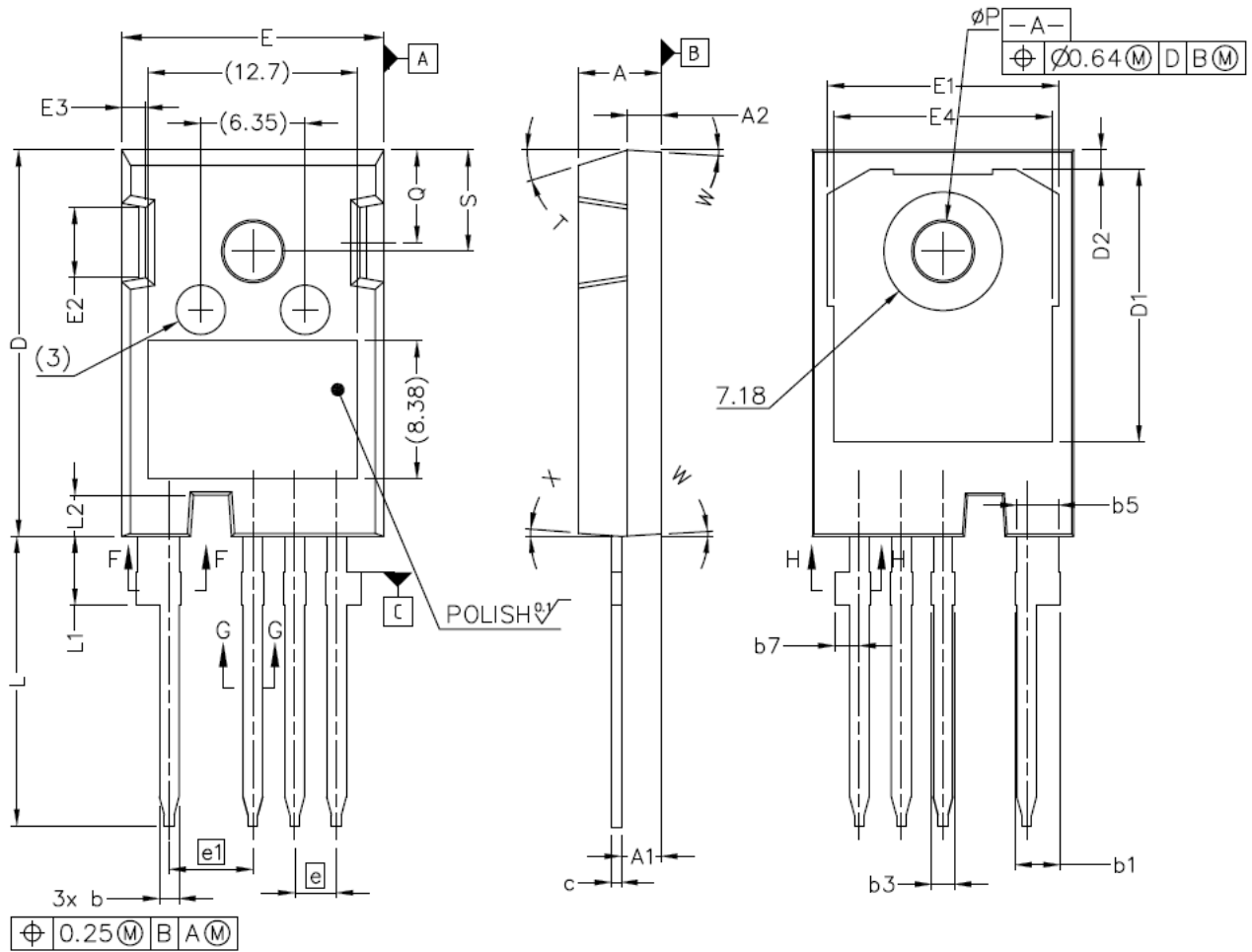

Figure 30. Clamped Inductive Switching Waveform Test Circuit

Note (3): Turn-off and Turn-on switching energy and timing values measured using SiC MOSFET Body Diode as shown above.

Package Dimensions

Package TO-247-4L



SECTION "F-F", "G-G" AND "H-H"
SCALE: NONE

Package Dimensions

Package TO-247-4L

SYM	MILLIMETERS	
	MIN	MAX
A	4.83	5.21
A1	2.29	2.54
A2	1.91	2.16
b`	1.07	1.28
b	1.07	1.33
b1	2.39	2.94
b2	2.39	2.84
b3	1.07	1.60
b4	1.07	1.50
b5	2.39	2.69
b6	2.39	2.64
b7	1.30	1.70
c`	0.55	0.65
c	0.55	0.68
D	23.30	23.60
D1	16.25	17.65
D2	0.95	1.25
E	15.75	16.13

SYM	MILLIMETERS	
	MIN	MAX
E1	13.10	14.15
E2	3.68	5.10
E3	1.00	1.90
E4	12.38	13.43
e	2.54 BSC	
e1	5.08 BSC	
N*	4	
L	17.31	17.82
L1	3.97	4.37
L2	2.35	2.65
Ø P	3.51	3.65
Q	5.49	6.00
S	6.04	6.30
T	17.5° REF.	
W	3.5° REF.	
X	4° REF.	

