



* Pb Free Part



Customer Name	Standard	TAIYO YUDEN Mobile Technology Co., Ltd.	
System	GPS+GLONASS+Compass	Date	Dec. 19, 2018
Part Number	F6QA1G582H2JM	Version 2.3bA	Final

Electrical Specification

Table-1

Item		Condition (MHz)	Specification			Unit	Remarks
			Min.	Typ.	Max.		
Insertion loss(*1)		1574.42 - 1576.42	-	1.2	1.7	dB	
		1597.55 - 1605.89	-	1.8	2.5	dB	
		1559.05 - 1563.14	-	1.7	2.5	dB	
Ripple		1574.42 - 1576.42	-	0.1	0.8	dB	
		1597.55 - 1605.89	-	0.6	1.4	dB	
		1559.05 - 1563.14	-	0.2	1.2	dB	
VSWR	Input	1574.42 - 1576.42	-	1.5	2.1	-	
		1597.55 - 1605.89	-	1.4	2.0	-	
		1559.05 - 1563.14	-	1.5	2.0	-	
	Output	1574.42 - 1576.42	-	1.5	2.1	-	
		1597.55 - 1605.89	-	1.4	2.0	-	
		1559.05 - 1563.14	-	1.5	2.0	-	
Group delay ripple		1574.42 - 1576.42	-	1.0	6.0	ns	
		1597.55 - 1605.89	-	4.0	12.5	ns	
		1559.05 - 1563.14	-	5.0	16.0	ns	
Absolute attenuation		699 - 716	43	47	-	dB	
		777 - 787	45	46.5	-	dB	
		814 - 849	45	46.5	-	dB	
		880 - 915	45	46.5	-	dB	
		1427.9 - 1446.9	45	53	-	dB	
		1447.9 - 1462.9	45	54	-	dB	
		1710 - 1785	47	54	-	dB	
		1850 - 1915	47	54	-	dB	
		1920 - 1980	47	54	-	dB	
		2400 - 2500	45	50	-	dB	
2500 - 2570	45	50	-	dB			



* Pb Free Part



Customer Name	Standard	TAIYO YUDEN Mobile Technology Co., Ltd.	
System	GPS+GLONASS+Compass	Date	Dec. 19, 2018
Part Number	F6QA1G582H2JM	Version 2.3bA	Final

Item	Condition (MHz)	Specification			Unit	Remarks
		Min.	Typ.	Max.		
Terminating Impedance	Input port	50			Ω	
	Output port	50			Ω	
Operating Temperature		-30 to +85			$^{\circ}\text{C}$	
Maximum DC in all ports		-	-	5	VDC	Device only
DC impedance to ground		100			M Ω	Device only
Device size (L typ. xW typ. xH max.)		1.1 x 0.9 x 0.5			mm	

(*1) Specification of insertion loss excludes loss that comes from the test board.



* Pb Free Part

Customer Name	Standard	TAIYO YUDEN Mobile Technology Co., Ltd.	
System	GPS+GLONASS+Compass	Date	Dec. 19, 2018
Part Number	F6QA1G582H2JM	Version 2.3bA	Final

Dimensions

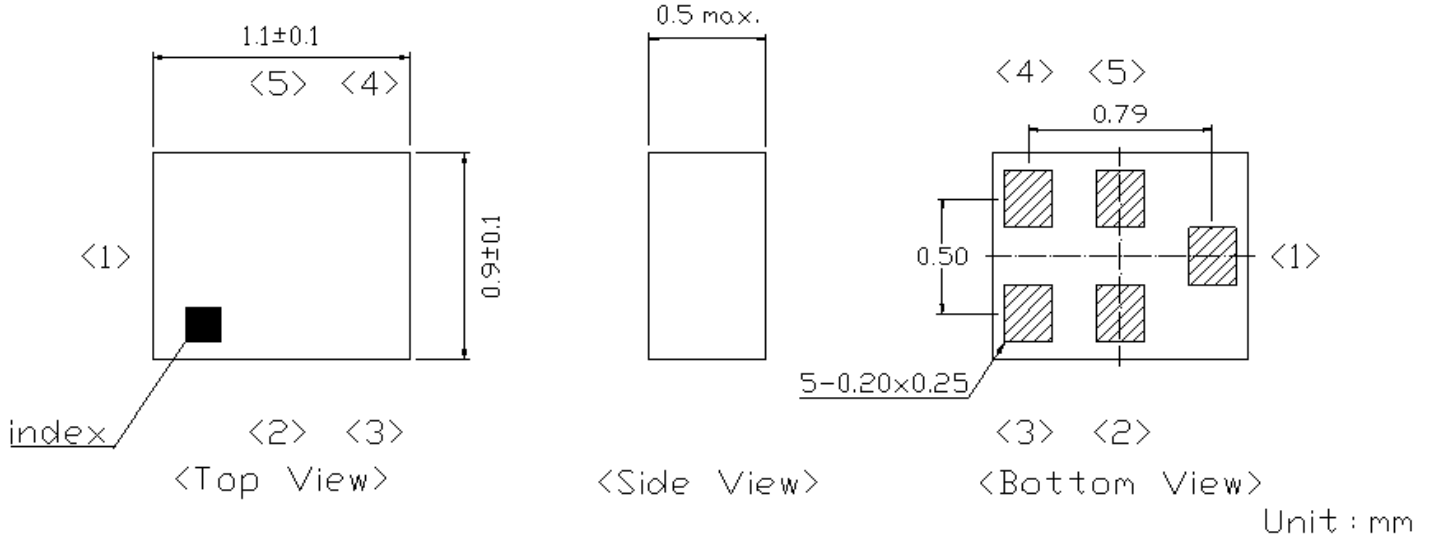

Figure-1

Pin Configuration

Table-2

Pin No.	Symbol	Function
1	IN	Input
2	GND	Ground
3	GND	Ground
4	OUT	Output
5	GND	Ground



* Pb Free Part

Customer Name	Standard	TAIYO YUDEN Mobile Technology Co., Ltd.	
System	GPS+GLONASS+Compass	Date	Dec. 19, 2018
Part Number	F6QA1G582H2JM	Version 2.3bA	Final

Evaluation Circuit

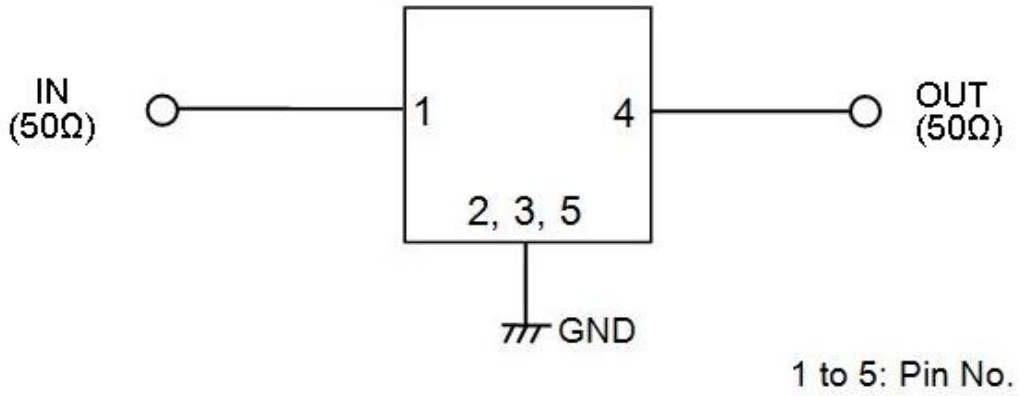

Figure-2

Recommended Foot Print Pattern

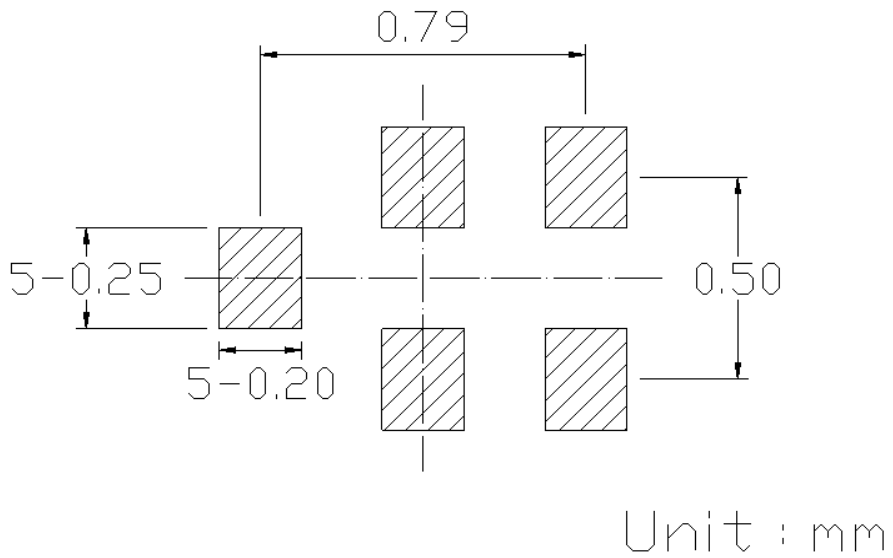

Figure-3



* Pb Free Part

Customer Name	Standard	TAIYO YUDEN Mobile Technology Co., Ltd.	
System	GPS+GLONASS+Compass	Date	Dec. 19, 2018
Part Number	F6QA1G582H2JM	Version 2.3bA	Final

Electrical Characteristics

Passband

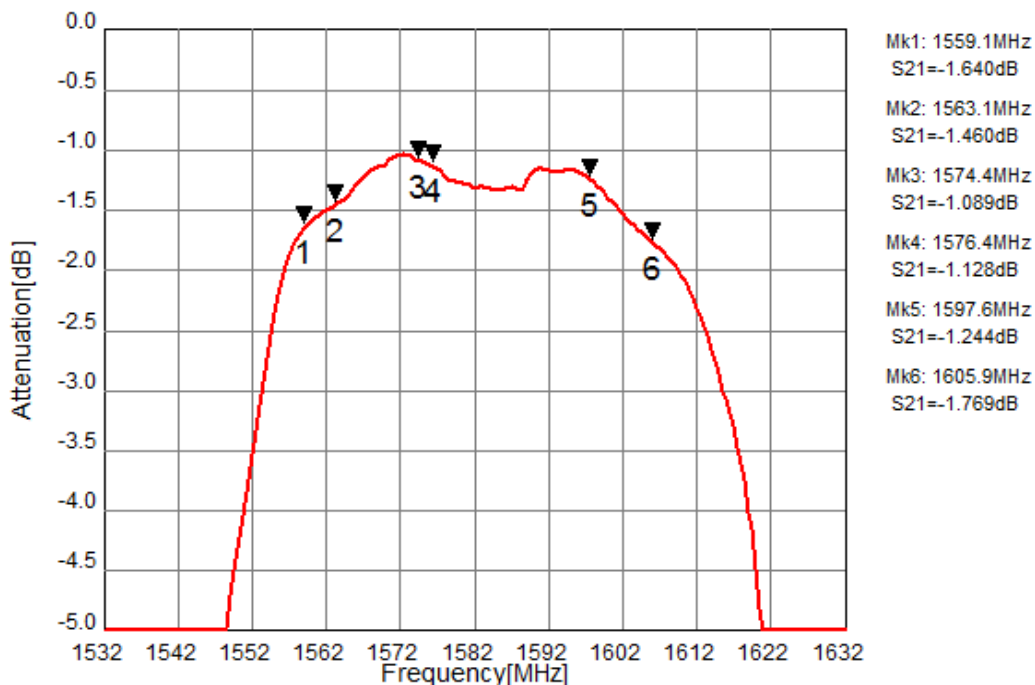
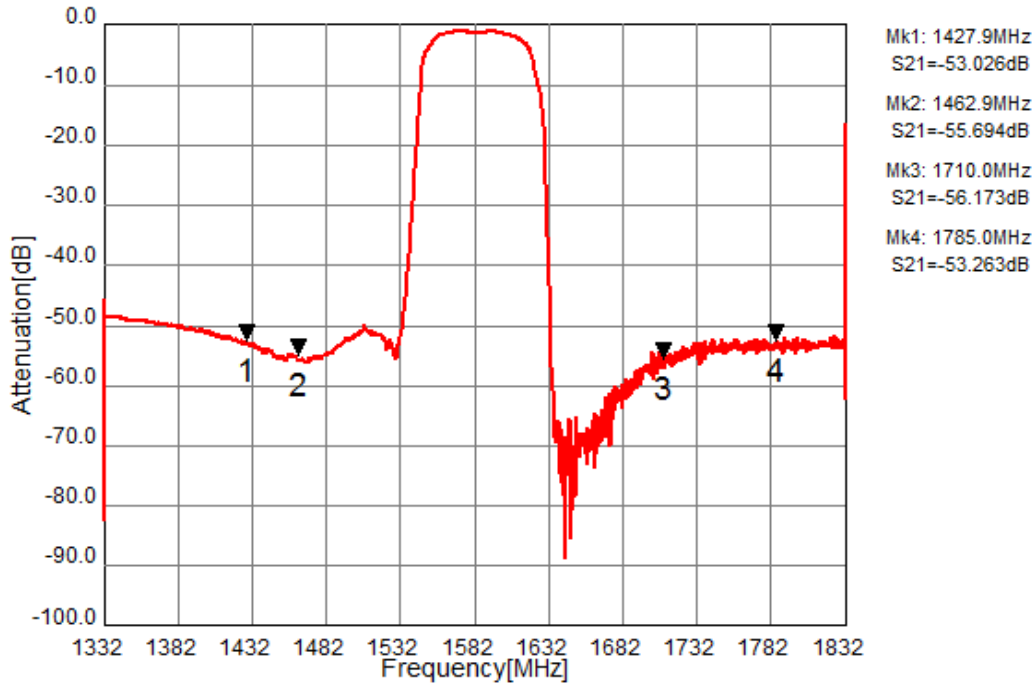

Figure-4-1

These data exclude loss that comes from the test board.

TAIYO YUDEN



* Pb Free Part

Customer Name	Standard	TAIYO YUDEN Mobile Technology Co., Ltd.	
System	GPS+GLONASS+Compass	Date	Dec. 19, 2018
Part Number	F6QA1G582H2JM	Version 2.3bA	Final

Input Port

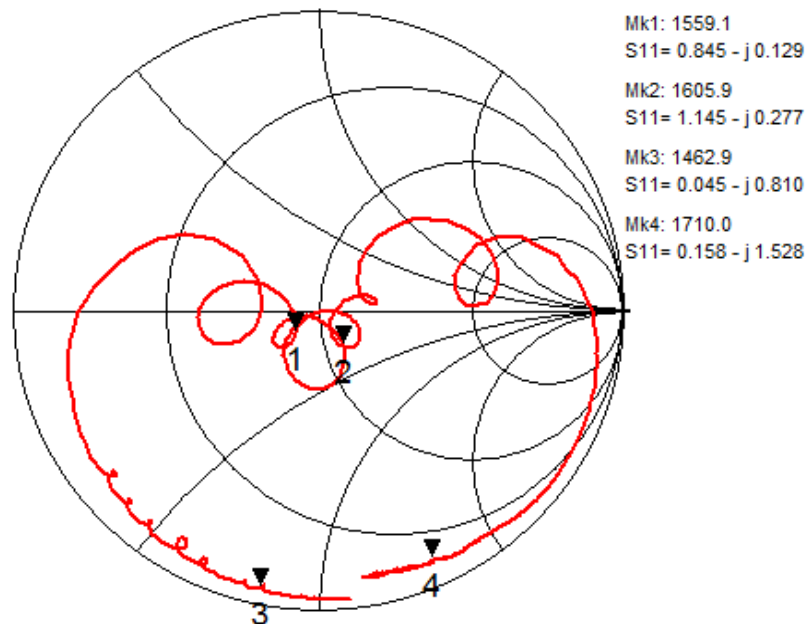
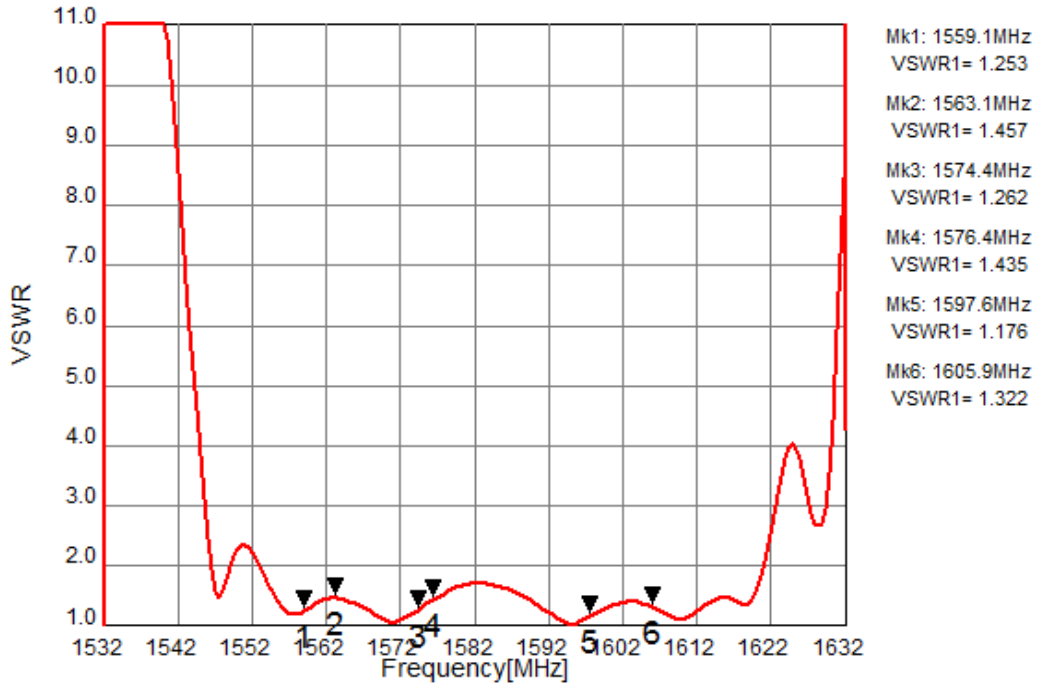

Figure-4-2

These data exclude loss that comes from the test board.



* Pb Free Part

Customer Name	Standard	TAIYO YUDEN Mobile Technology Co., Ltd.	
System	GPS+GLONASS+Compass	Date	Dec. 19, 2018
Part Number	F6QA1G582H2JM	Version 2.3bA	Final

Output Port

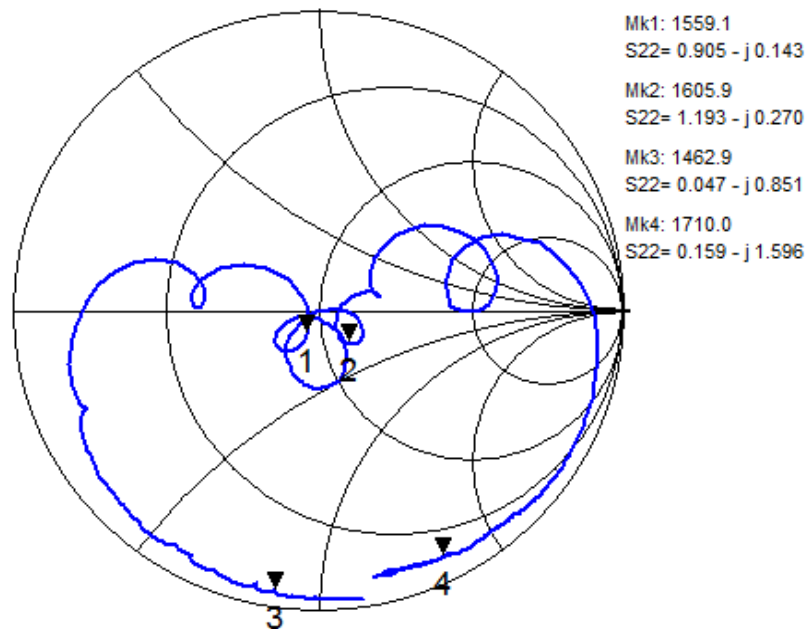
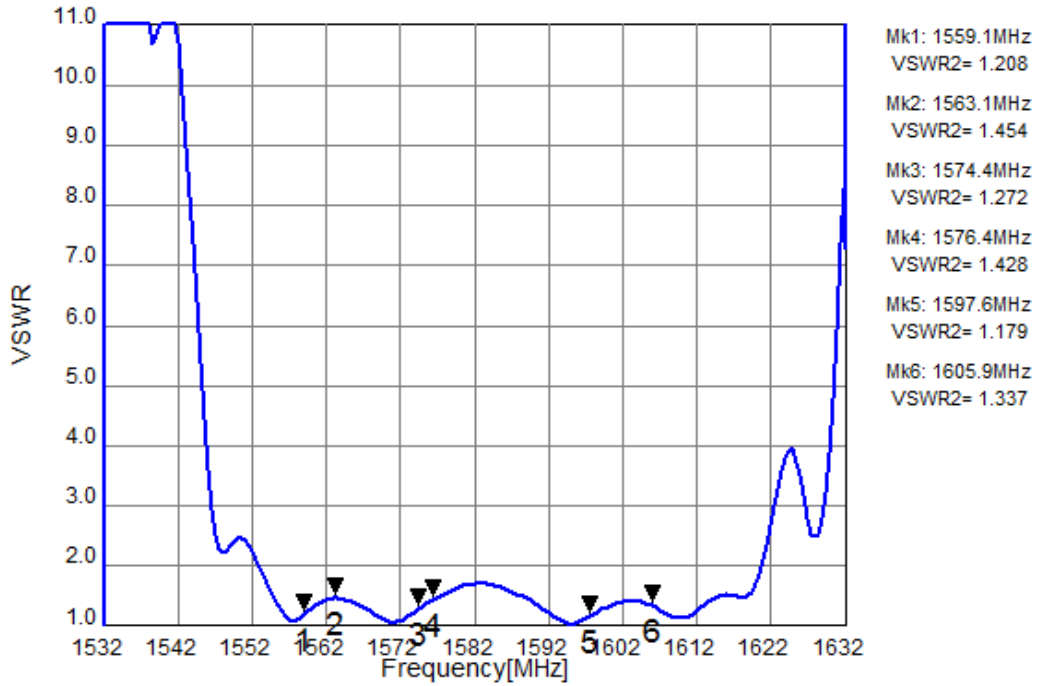

Figure-4-3

These data exclude loss that comes from the test board.



* Pb Free Part

Customer Name	Standard	TAIYO YUDEN Mobile Technology Co., Ltd.	
System	GPS+GLONASS+Compass	Date	Dec. 19, 2018
Part Number	F6QA1G582H2JM	Version 2.3bA	Final

Wide span

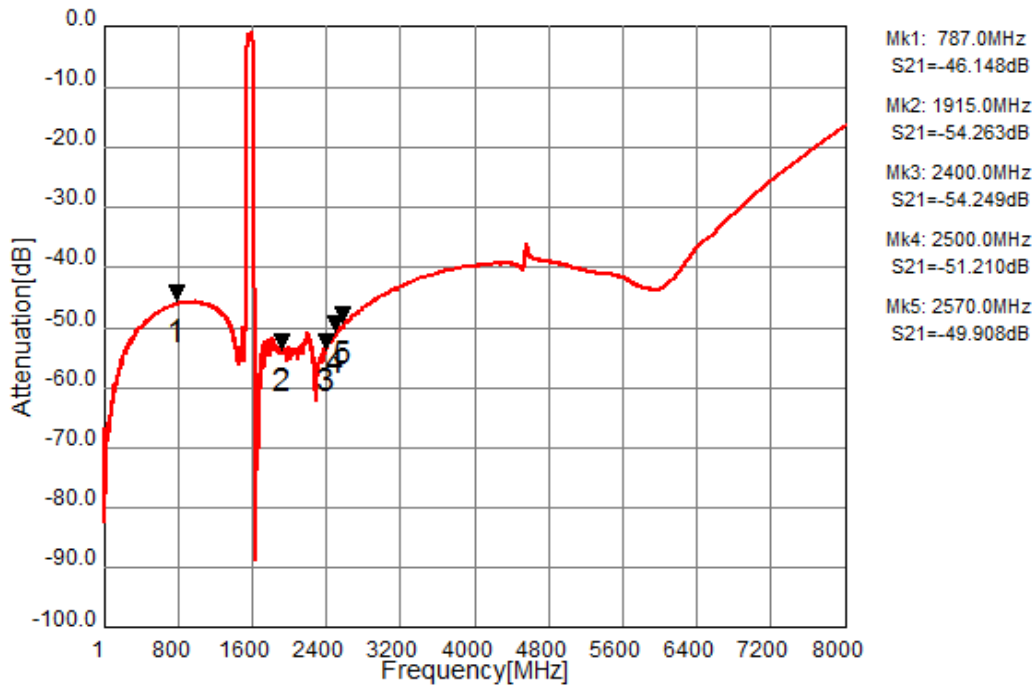

Group delay

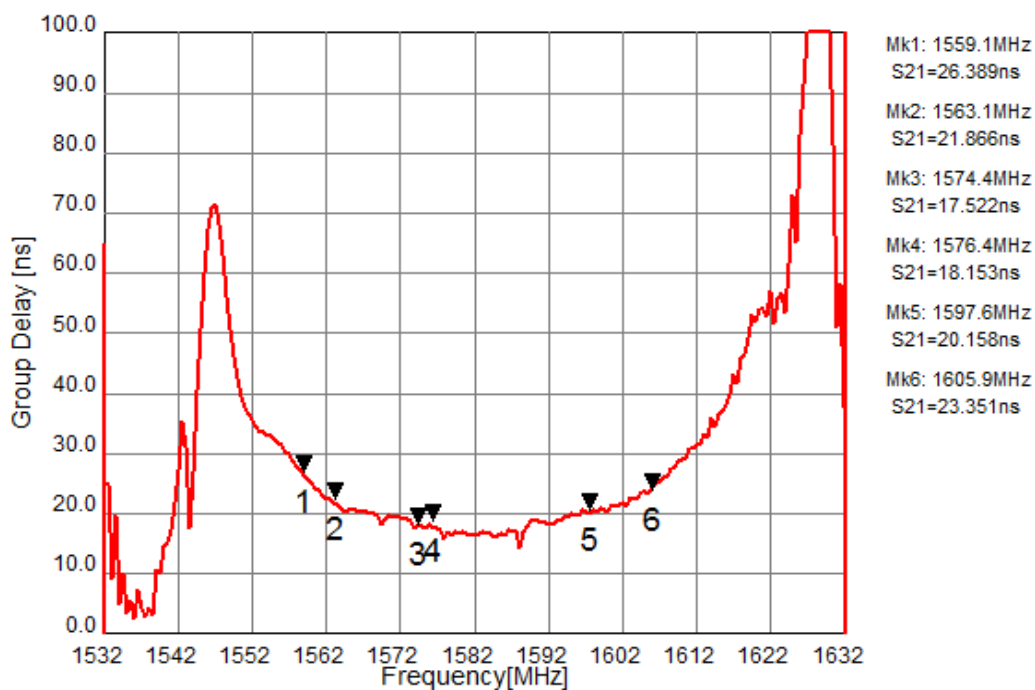

Figure-4-4

These data exclude loss that comes from the test board.





* Pb Free Part



Customer Name	Standard	TAIYO YUDEN Mobile Technology Co., Ltd.	
System	GPS+GLONASS+Compass	Date	Dec. 19, 2018
Part Number	F6QA1G582H2JM	Version 2.3bA	Final

Ordering Code

Standard Ordering Code	Packing	Reel size	Status
F6QA1G582H2JM-X	Tape & Reel	10,000 pcs.	MP

Option Ordering Code	Packing	Reel size	Status
F6QA1G582H2JM-XA	Tape & Reel	less than 10,000 pcs.	MP
F6QA1G582H2JM-Y	Tape & Reel	15,000 pcs.	MP
F6QA1G582H2JM-YA	Tape & Reel	less than 15,000 pcs.	MP
F6QA1G582H2JM-J	Tape & Reel	5,000 pcs.	MP
F6QA1G582H2JM-JA	Tape & Reel	less than 5,000 pcs.	MP
F6QA1G582H2JM-Q	Bulk	few pcs.	MP

*Minimum order quantity (MOQ) is assigned for each inquiry, Please contact to Sales Representatives.

*MP : Mass Production



* Pb Free Part

Customer Name	Standard	TAIYO YUDEN Mobile Technology Co., Ltd.	
System	GPS+GLONASS+Compass	Date	Dec. 19, 2018
Part Number	F6QA1G582H2JM	Version 2.3bA	Final

Tape and Reel Information

Dimensions of Tape (Standard)

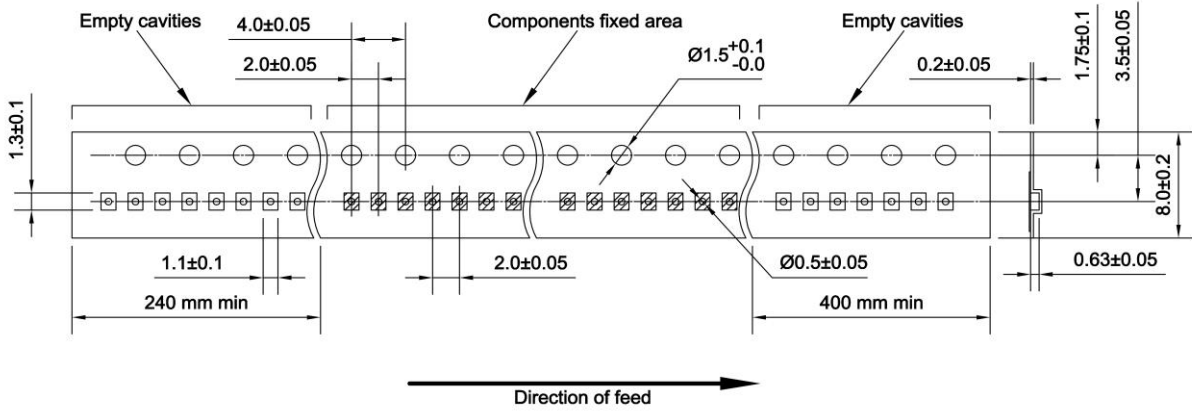

Dimensions of Reel

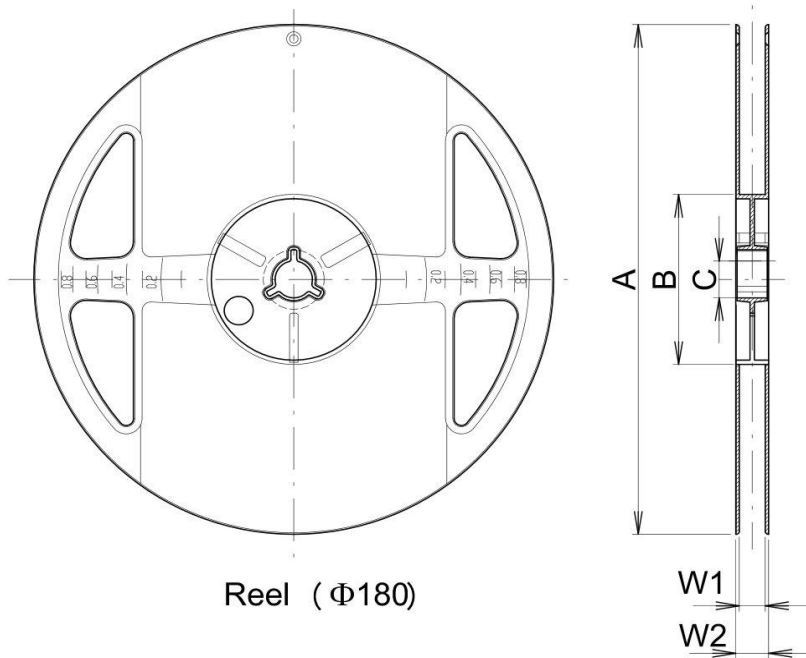

Order	Code	Quantity (pcs./reel)	A	B	C	W1	W2	Tape Pitch
Standard	X	10,000	$\phi 180$	$\phi 60$	$\phi 13 \pm 0.2$	$9^{+1.0/-0.0}$	11.4 ± 1.0	2.0 ± 0.05
Option	Y	15,000	$\phi 330$	$\phi 100$	$\phi 13 \pm 0.2$	9.4 ± 1.0	13.4 ± 1.0	4.0 ± 0.1
Option	J	5,000	$\phi 180$	$\phi 60$	$\phi 13 \pm 0.2$	$9^{+1.0/-0.0}$	11.4 ± 1.0	4.0 ± 0.1

Unit:mm



* Pb Free Part



Customer Name	Standard	TAIYO YUDEN Mobile Technology Co., Ltd.	
System	GPS+GLONASS+Compass	Date	Dec. 19, 2018
Part Number	F6QA1G582H2JM	Version 2.3bA	Final

Notice

- Please conduct validation and verification of our products in actual condition of mounting and operating environment before using our products.
- The products listed in this specification are intended for use in general electronic equipment (e.g., AV equipment, OA equipment, home electric appliances, office equipment, information and communication equipment including, without limitation, mobile phone, and PC). Please be sure to contact TAIYO YUDEN for further information before using the products for any equipment which may directly cause loss of human life or bodily injury (e.g., transportation equipment including, without limitation, automotive powertrain control system, train control system, and ship control system, traffic signal equipment, disaster prevention equipment, medical equipment classified as Class I, II or III by IMDRF, highly public information network equipment including, without limitation, telephone exchange, and base station).
Please do not incorporate our products into any equipment requiring high levels of safety and/or reliability (e.g., aerospace equipment, aviation equipment, medical equipment classified as Class IV by IMDRF, nuclear control equipment, undersea equipment, military equipment).
When our products are used even for high safety and/or reliability-required devices or circuits of general electronic equipment, it is strongly recommended to perform a thorough safety evaluation prior to use of our products and to install a protection circuit as necessary.
Please note that unless you obtain prior written consent of TAIYO YUDEN, TAIYO YUDEN shall not be in any way responsible for any damages incurred by you or third parties arising from use of the products listed in this specification for any equipment requiring inquiry to TAIYO YUDEN or prohibited for use by TAIYO YUDEN as described above.
- Information contained in this specification is intended to convey examples of typical performances and/or applications of our products and is not intended to make any warranty with respect to the intellectual property rights or any other related rights of TAIYO YUDEN or any third parties nor grant any license under such rights.
- Please note that the scope of warranty for our products is limited to the delivered our products themselves and TAIYO YUDEN shall not be in any way responsible for any damages resulting from a fault or defect in our products. Notwithstanding the foregoing, if there is a written agreement (e.g., supply and purchase agreement, quality assurance agreement) signed by TAIYO YUDEN and your company, TAIYO YUDEN will warrant our products in accordance with such agreement.
- The contents of this specification are applicable to our products which are purchased from our sales offices or authorized distributors (hereinafter "TAIYO YUDEN's official sales channel"). Please note that the contents of this specification are not applicable to our products purchased from any seller other than TAIYO YUDEN's official sales channel.
- Caution for Export
Some of our products listed in this specification may require specific procedures for export according to "U.S. Export Administration Regulations", "Foreign Exchange and Foreign Trade Control Law" of Japan, and other applicable regulations. Should you have any questions on this matter, please contact our sales staff.