



ORIENT

Photo coupler

Product Data Sheet

Part Number: OR-M302X(L)/M305X(L)/M307X(L)

Customer: _____

Date: _____

SHENZHEN ORIENT COMPONENTS CO., LTD

Block A 3rd Floor No.4 Building, Tian'an Cyber Park, Huangge Rd, LongGang Dist, Shenzhen, GD

TEL: 0755-29681816
FAX: 0755-29681200
www.orient-opto.com

1. Features

- (1) High isolation voltage between input and output (Viso:3750 V rms)
- (2) 4pin non zero-cross optoisolators triac driver output
- (3) High repetitive peak off-state voltage VDRM :
M302X: Min. 400V, M305X: Min. 600V, M307X: Min. 800V
- (4) High critical rate of rise of off-state voltage dv/dt :
M302X: Typ. 100V / μ s , M305X/M307X:MIN . 1000V / μ s
- (5) Tape and reel packaging.
- (6) Operating temperature -40 °Cto +110 °C
- (7) Safety approval
UL approved(No.E323844)
VDE approved(No.40029733)
CQC approved (No.CQC19001231256)
- (8) In compliance with RoHS, REACH standards
- (9) MSL Class I



2. Description

The OR-M302X(L)/M305X(L)/M307X(L) consists of a non zero crossing photo triac, optically coupled to a gallium arsenide infrared emitting diode. They are housed in the SOP-4 package and guarantees insulation thickness. Therefore, they meet the reinforced insulation class requirements of international safety standards.

3. Application Range

- AC Motor Drives
- AC Motor Starters
- Static power switch
- Lighting Controls
- Solenoid/Valve Controls
- Solid State Relays
- Temperature Controls

4. Functional Diagram

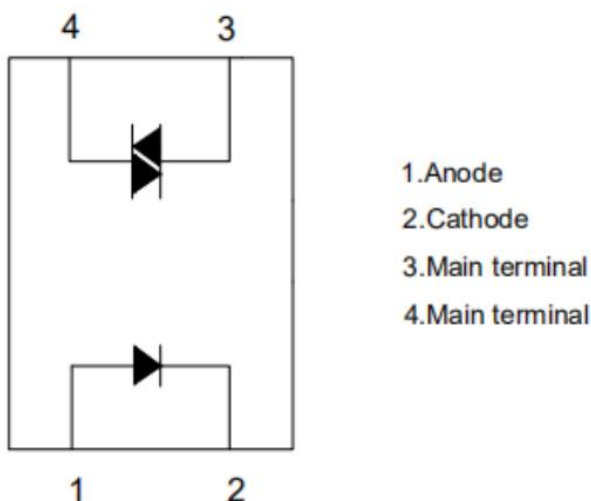

5. Absolute Maximum Ratings (Ta=25°C)

Parameter		Symbol	Rated Value	Unit	
Input	Forward Current	I_F	50	mA	
	Junction Temperature	T_J	125	°C	
	Reverse Voltage	V_R	6	V	
	Power Dissipation	P	100	mW	
Output	Off-State Output Terminal Voltage	OR-M302X	V_{DRM}	400	V
		OR-M305X		600	
		OR-M307X		800	
	On state RMS current		$I_{T(RMS)}$	100	mA(RMS)
	Peak Repetitive Surge Current (PW=1ms, 120 pps)		I_{TSM}	1	A
	Junction Temperature		T_J	125	°C
	Collector Power Dissipation		P_C	300	mW
	Total Power Dissipation		P_{tot}	330	mW
*1 Insulation Voltage		V_{iso}	3750	V _{rms}	
Working Temperature		T_{opr}	-40 ~ + 110	°C	
Deposit Temperature		T_{stg}	-55 ~ + 125		
*2 Soldering Temperature		T_{sol}	260		

Notes:

*1 AC for 1 minute, R.H.= 40 ~ 60% R.H. In this test, pins 1, 2&3 are shorted together, and pins 4, 6 are shorted together.

* 2 For 10 seconds

6. Electrical Optical Characteristics at Ta=25°C

Parameter		Symbol	Min	Typ.*	Max	Unit	Condition	
Input	Forward Voltage	V_F	---	1.2	1.6	V	$I_F=10\text{mA}$	
	Reverse Current	I_R	---	---	5	μA	$V_R=6\text{V}$	
Output	*1.Peak Blocking Current, Either Direction	OR-M302X OR-M305X	---	10	100	nA	$V_{\text{DRM}} = \text{Rated } V_{\text{DRM}}$	
		OR-M307X		---	---			500
	Peak On-State Voltage, Either Direction	V_{TM}	---	---	2.5	V	$I_{\text{TM}}=100\text{mA}$ Peak	
*2.Critical rate of Rise of Off-State Voltage	OR-M302X	dv/dt	---	100	---	$\text{V}/\mu\text{s}$	$V_{\text{in}}=240\text{Vrms}$	
	OR-M305X OR-M307X			1000	---			---
Transfer Characteristics	*3.Led Trigger Current, Current Required to Latch Output, Either Direction	OR-M3020 OR-M3050 OR-M3070	I_{FT}	---	---	30	mA	Main Terminal Voltage = 3V
		OR-M3021 OR-M3051 OR-M3071		---	---	15		
		OR-M3022 OR-M3052 OR-M3072		---	---	10		
		OR-M3023 OR-M3053 OR-M3073		---	---	5		
		OR-M3024 OR-M3054 OR-M3074		---	---	3.5		
	Holding Current, Either Direction	I_H	0.5	1.0	5.0	mA		
Turn-On Time	T_{on}	---	---	100	μs	$V_D=6\text{V}$ $R_L=100\Omega$ $I_F=20\text{mA}$		

*1. Test voltage must be applied within dv/dt rating.

*2. This is static dv/dt . Commutating dv/dt is a function of the load-driving thyristor(s) only.

*3. All devices are guaranteed to trigger at an I_F value less than or equal to max I_{FT} . Therefore, recommended operating I_F lies between max I_{FT} , 30 mA for OR-M3020 and OR-M3050, 15 mA for OR-M3021 and OR-M3051, 10 mA for OR-M3022 and OR-M3052, 5 mA for OR-M3023 and OR-M3053, 3.5 mA for OR-M3024 and OR-M3054, and absolute max I_F (50mA).



7. Order Information

Part Number

OR-M302X(L)-W-Y-Z

OR-M305X(L)-W-Y-Z

Or **OR-M307X(L)-W-Y-Z**

Note

M302X(L)/M305X(L)/M307X(L) = Part Number(X = 0,1,2,3 or 4)

W = Tape and reel option (TP or TP1).

Y = 'V' code for VDE safety (This options is not necessary).

Z = 'G' code for Halogen free.

* VDE Code can be selected.

Option	Description	Packing quantity
TP	Surface mount lead form (low profile) + TP tape & reel option	3000 units per reel
TP1	Surface mount lead form (low profile) + TP1 tape & reel option	3000 units per reel

8. Naming Rule

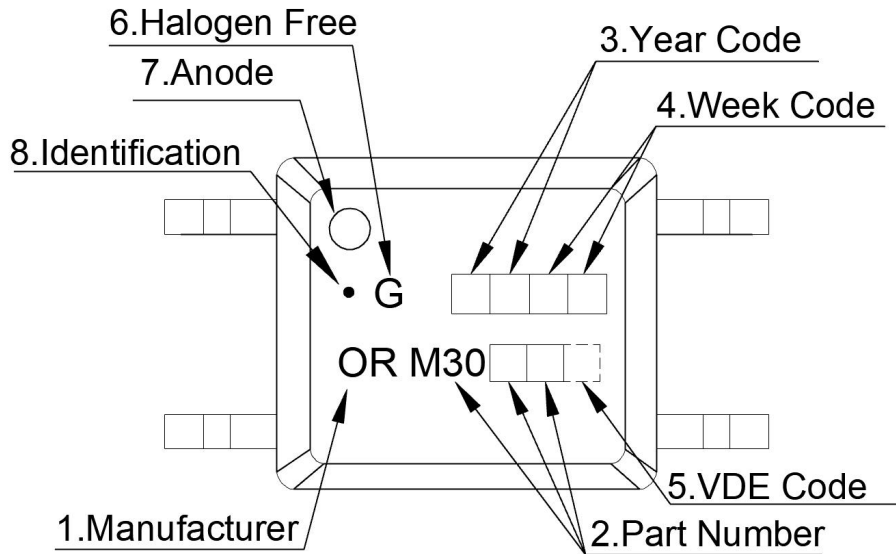

1. Manufacturer : ORIENT.
2. Part Number : M30 .
3. Year Code : '21' means '2021' and so on.
4. Week Code : 01 means the first week, 02 means the second week and so on.
5. VDE Code . (Optional)
6. HF Code 'G': Halogen Free.
7. Anode.
8. Identification.

* VDE Code can be selected.

9. Package Dimension

OR-M30XX

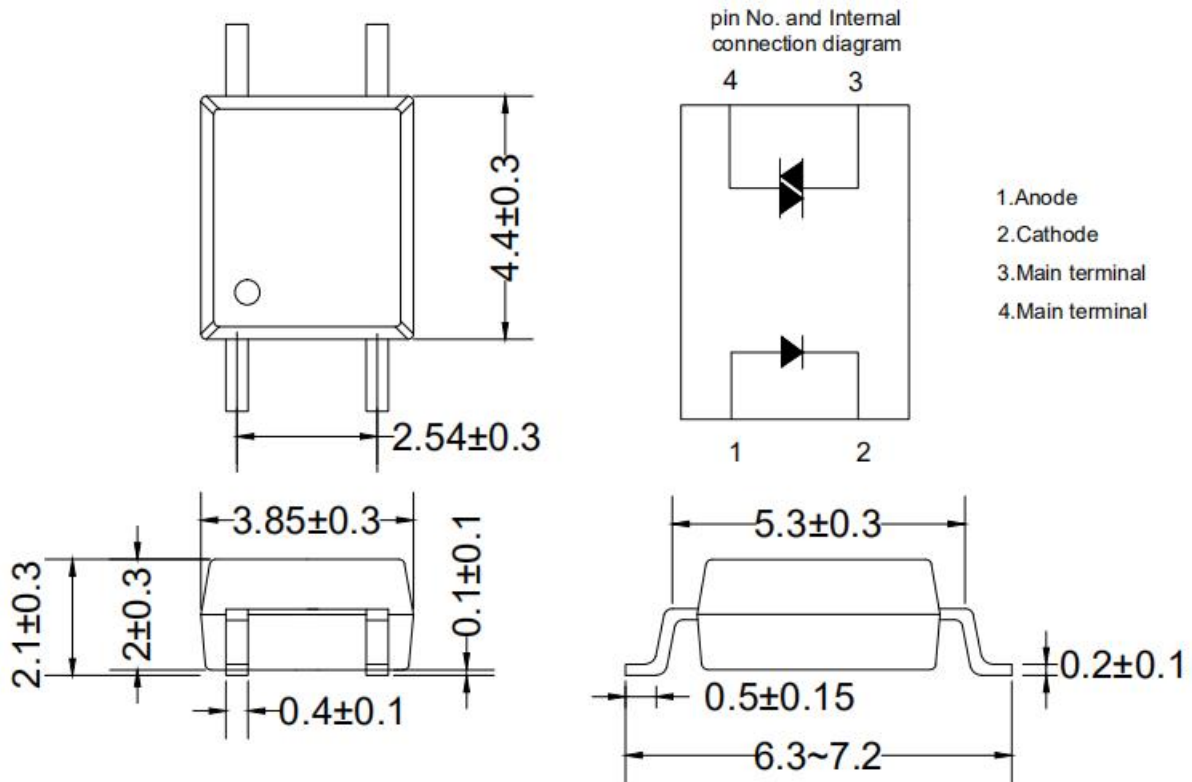

10. Recommended Foot Print Patterns (Mount Pad)

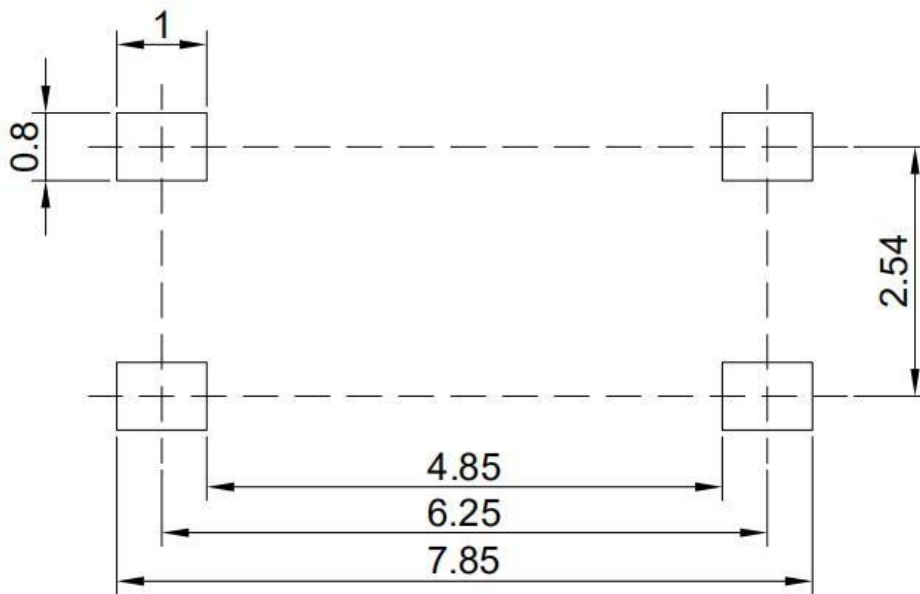

unit: mm

11. Taping Dimensions

(1)TP Type

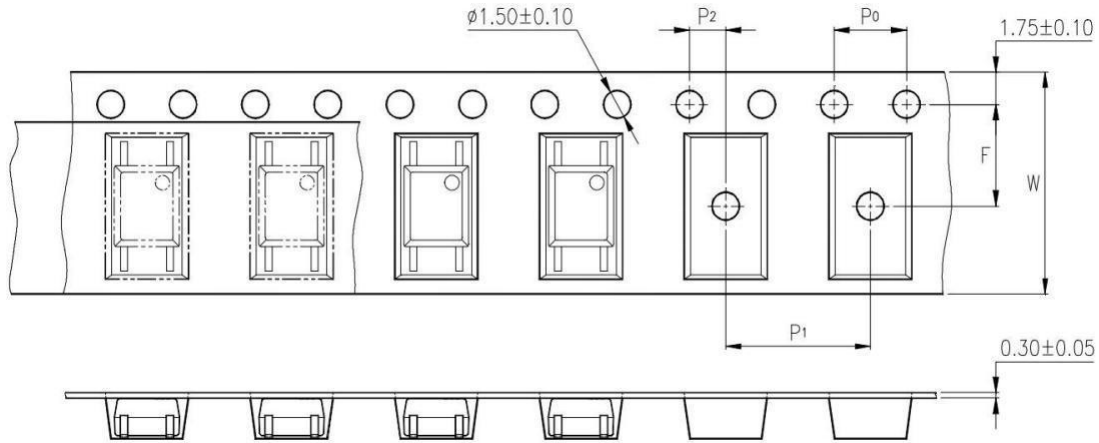

(2)TP1 Type

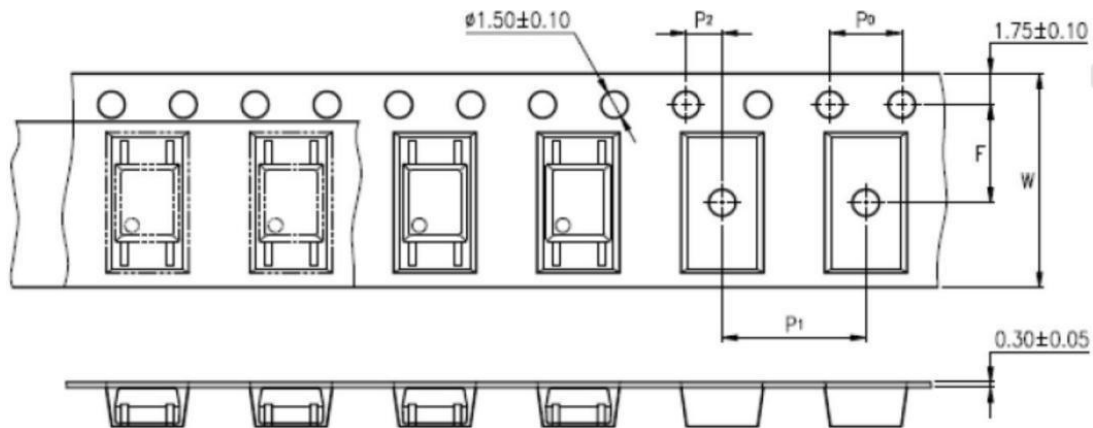

Description	Symbol	Dimension in mm (inch)
Tape wide	W	12±0.3 (0.472)
Pitch of sprocket holes	P0	4±0.1 (0.157)
Distance of compartment	F	5.5±0.1 (0.217)
	P2	2±0.1 (0.079)
Distance of compartment to compartment	P1	8±0.1 (0.315)

Package Type	TP/TP1
Quantities(pcs)	3000

12. Package Dimension



(1) package dimension

Packing Information	
Packing type	Reel type
Tape Width	12mm
Qty per Reel	3,000pcs
Small box (inner) Dimension	345*345*45mm
Large box (Outer) Dimension	480x360x360mm
Max qty per small box	6,000pcs
Max qty per large box	60,000pcs

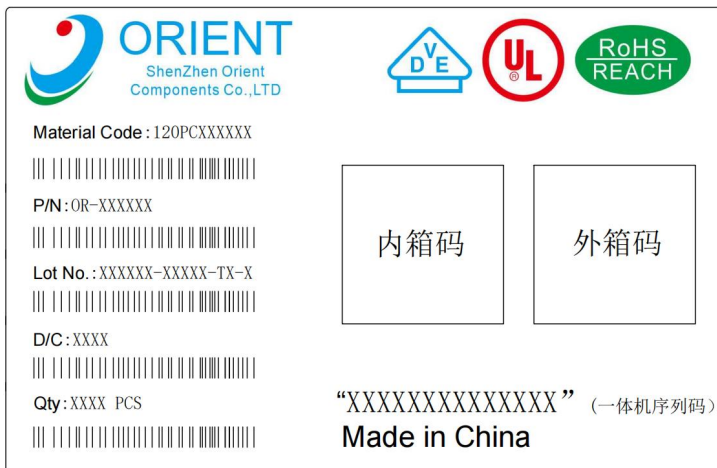
(2)Packing Label Sample





Material Code : 120PCXXXXXX
 P/N : OR-XXXXXX
 Lot No. : XXXXXX-XXXXX-TX-X
 D/C : XXXX
 Qty : XXXX PCS

内箱码 外箱码

“XXXXXXXXXXXXXXXXXX” (一体机序列码)
Made in China

Note:

1. Material Code :Product ID.
2. P/N :Contents with "Order Information" in the specification.
3. Lot No. :Product data.
4. D/C :Product weeks.
5. Quantity :Packaging quantity.

13. Temperature Profile Of Soldering

(1) IR Reflow soldering (JEDEC-STD-020C compliant)

One time soldering reflow is recommended within the condition of temperature and time profile shown below. Do not solder more than three times.

Profile item	Conditions
Preheat	
- Temperature Min (T Smin)	150°C
- Temperature Max (T Smax)	200°C
- Time (min to max) (ts)	90±30 sec
Soldering zone	
- Temperature (TL)	217°C
- Time (t L)	60 sec
Peak Temperature	260°C
Peak Temperature time	20 sec
Ramp-up rate	3°C / sec max.
Ramp-down rate from peak temperature	3~6°C / sec
Reflow times	≤3

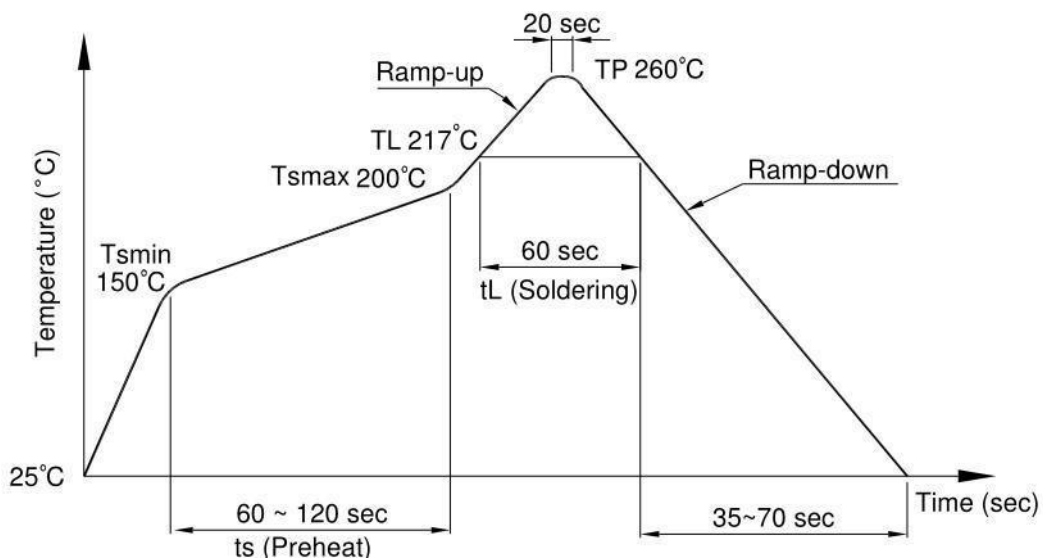

(2) Wave soldering (JEDEC22A111 compliant)

One time soldering is recommended within the condition of temperature.

Temperature	260+0/-5°C
Time	10 sec
Preheat temperature	5 to 140°C
Preheat time	30 to 80 sec

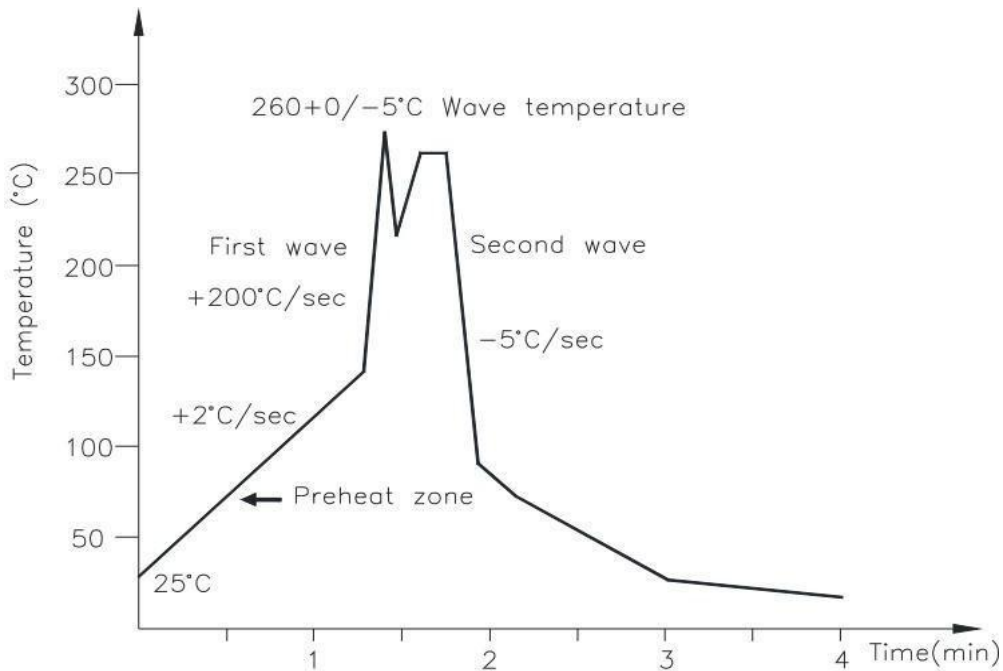

(3) Hand soldering by soldering iron

Allow single lead soldering in every single process. One time soldering is recommended.

Temperature	380+0/-5°C
Time	3 sec max

14. CHARACTERISTICS CURVES (TYPICAL PERFORMANCE)

Fig.1 Forward current vs Ambient temperature

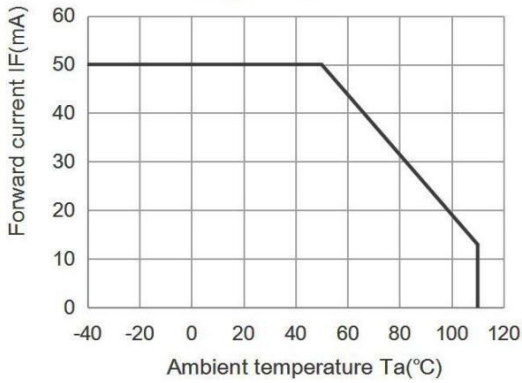

Fig.2 On-state current ITM (A) vs Ambient temperature

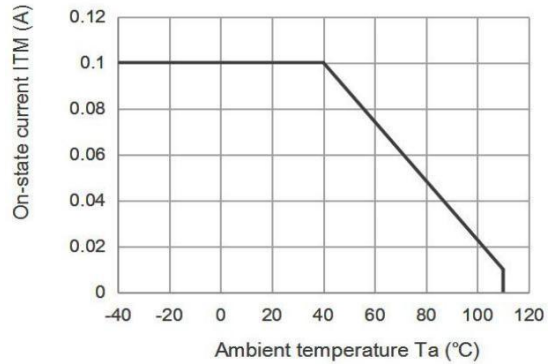

Fig.3 Minimum Trigger Current vs. Ambient temperature

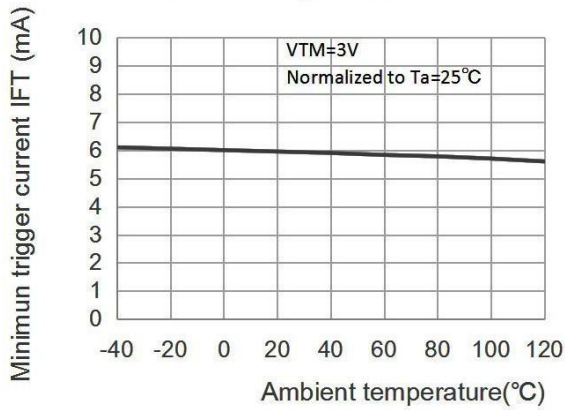

Fig.4 Forward current vs. Forward voltage

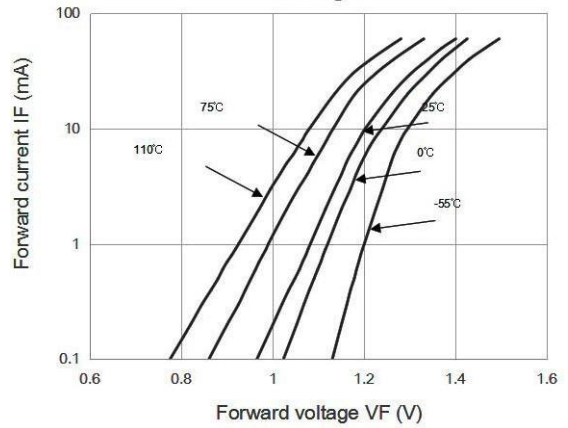

Fig.5 On-state voltage vs. Ambient temperature

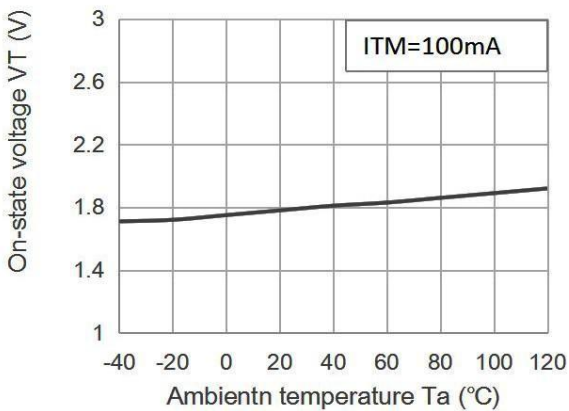

Fig.6 Holding current vs. Ambient temperature

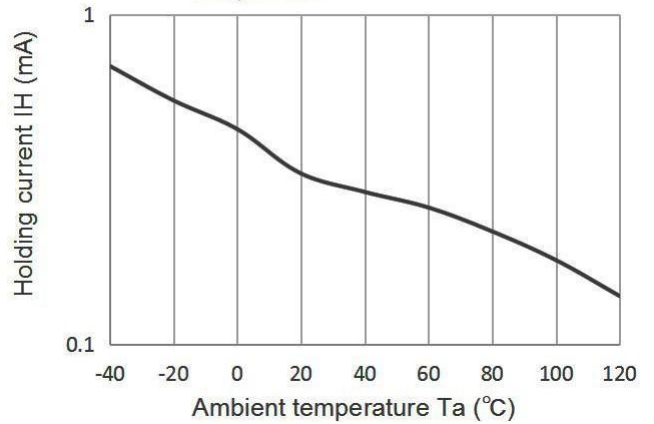

Fig.7 Repetitive peak off-state current vs. Temperature

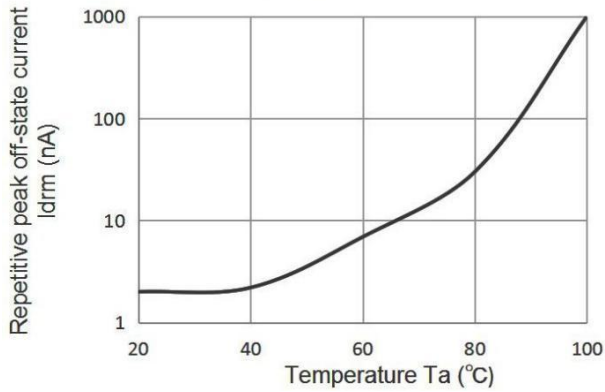

Fig.8 On-state current vs. On-state voltage

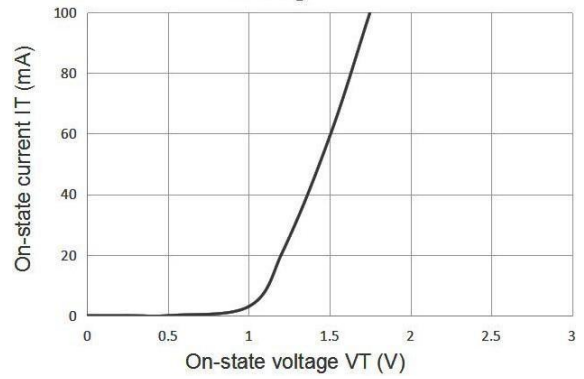

Fig9. Basic Operation Circuit Medium/High Power Triac Drive Circuit

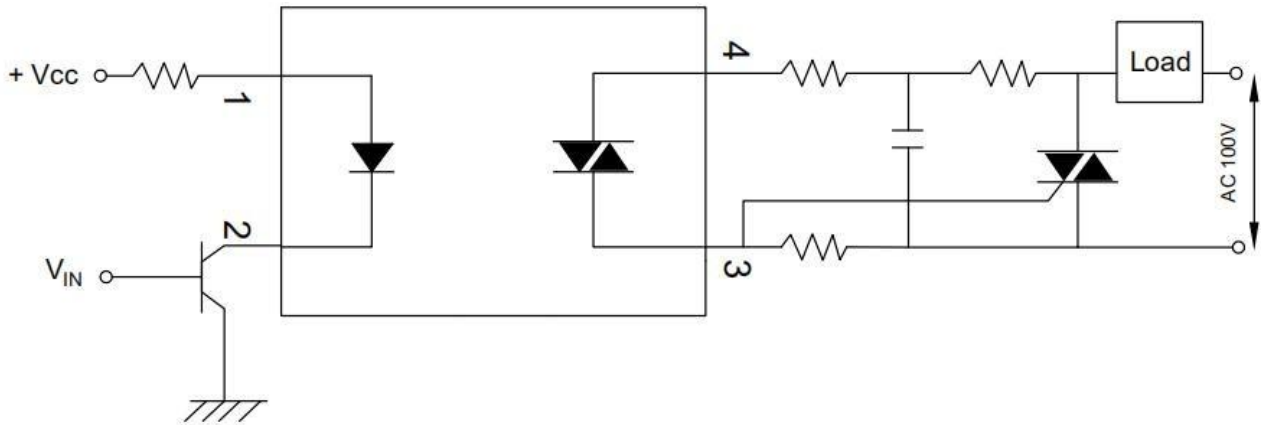
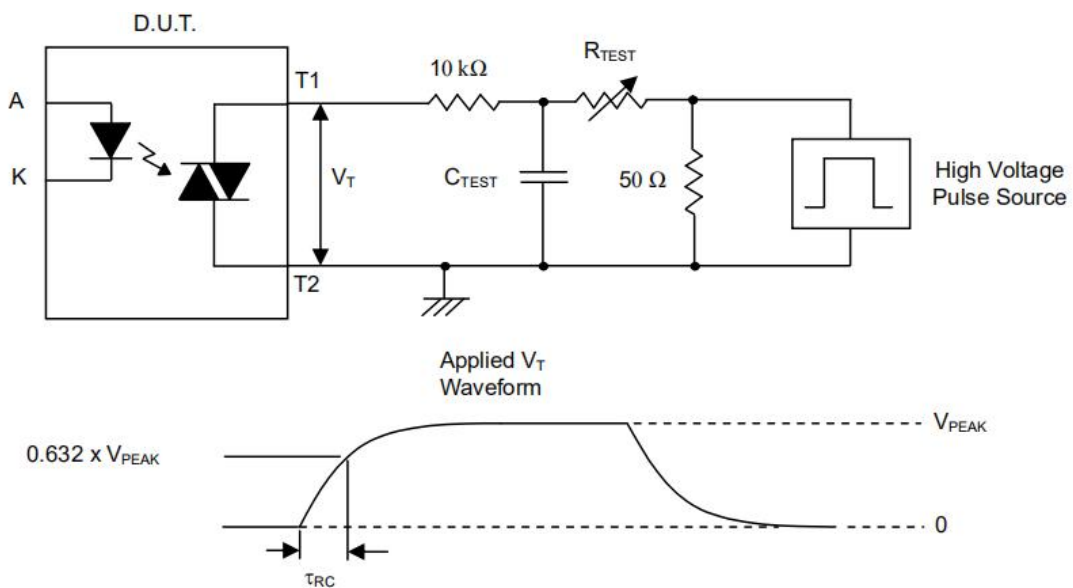

Fig10.Static dv/dt Test Circuit & Waveform



Measurement Method

The high voltage pulse is set to the required V_{PEAK} value and applied to the D.U.T. output side through the RC circuit above. LED current is not applied. The waveform V_T is monitored using a x100 scope probe. By varying R_{TEST} , the dv/dt (slope) is increased, until the D.U.T. is observed to trigger (waveform collapses). The dv/dt is then decreased until the D.U.T. stops triggering. At this point, τ_{RC} is recorded and the dv/dt calculated.

$$dv/dt = \frac{0.632 \times V_{PEAK}}{\tau_{RC}}$$

$$dv/dt = \frac{0.632 \times V_{PEAK}}{\tau_{RC}}$$

For example, $V_{PEAK} = 600V$ for EL306X series. The dv/dt value is calculated as follows:

$$dv/dt = \frac{0.63 \times 600}{\tau_{RC}} = \frac{378}{\tau_{RC}}$$