

REV.	ECN. NO.	APPD.
A	BC-14-0018366	Shih-Wei Hsiao
B	BC-14-0026746	Shih-Wei Hsiao
BX1	2014/09/26	Shih-Wei Hsiao
BX2	2014-09-29	Shih-Wei Hsiao
BX3	2015/04/24	Shih-Wei Hsiao
BX4	2015/04/29	Shih-Wei Hsiao

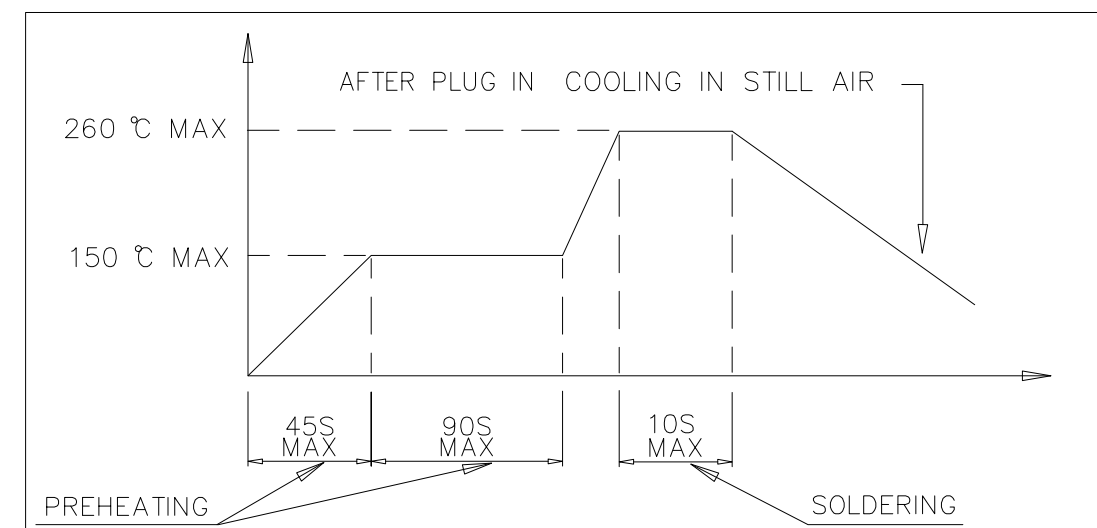

X.	X °	UNITS	mm	NAME (INTENDED USE)	<b>FOXCONN</b> FOXCONN INTERCONNECT TECHNOLOGY LIMITED		
.X ± 0.38	.X °	MAT'L		AUDIO JACK CONNECTOR 4 POLE			
.XX ± 0.25	.XX °			PART NO. (INTENDED USE)	CLASS: <input type="checkbox"/> CONFIDENTIAL <input type="checkbox"/> SECRET <input checked="" type="checkbox"/> GENERAL		
.XXX	.XXX °	FINISH		JA634*-40ADA5*-*H	TITLE: CUSTOMER DRAWING		
THESE DRAWINGS AND SPECIFICATIONS ARE THE PROPERTY OF FOXCONN INTERCONNECT TECHNOLOGY LIMITED, AND SHALL NOT BE REPRODUCED, COPIED OR USED IN ANY MANNER WITHOUT THE PRIOR WRITTEN CONSENT OF FOXCONN INTERCONNECT TECHNOLOGY LIMITED.				APPD:	Shih-wei Hsiao	DWG NO.:	305-0000-5589
				CHKD:	Rex Wang		
				DR:	Xuhui Qu	04/29'15	
					SCALE	SHEET	REV.
					N/A	1/4	BX4

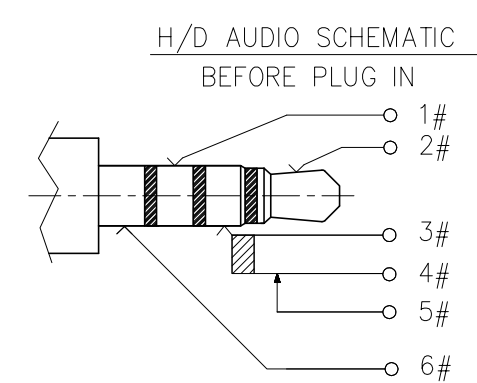

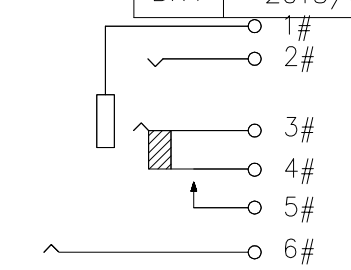
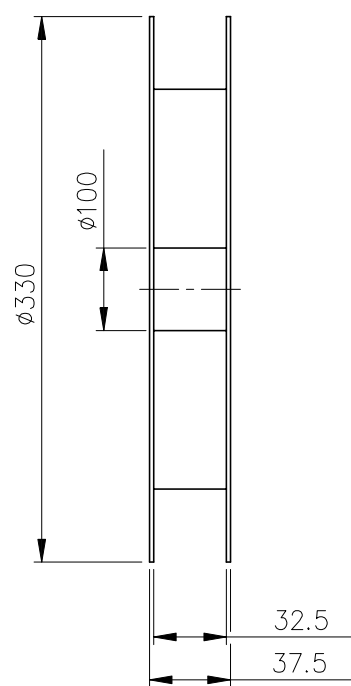
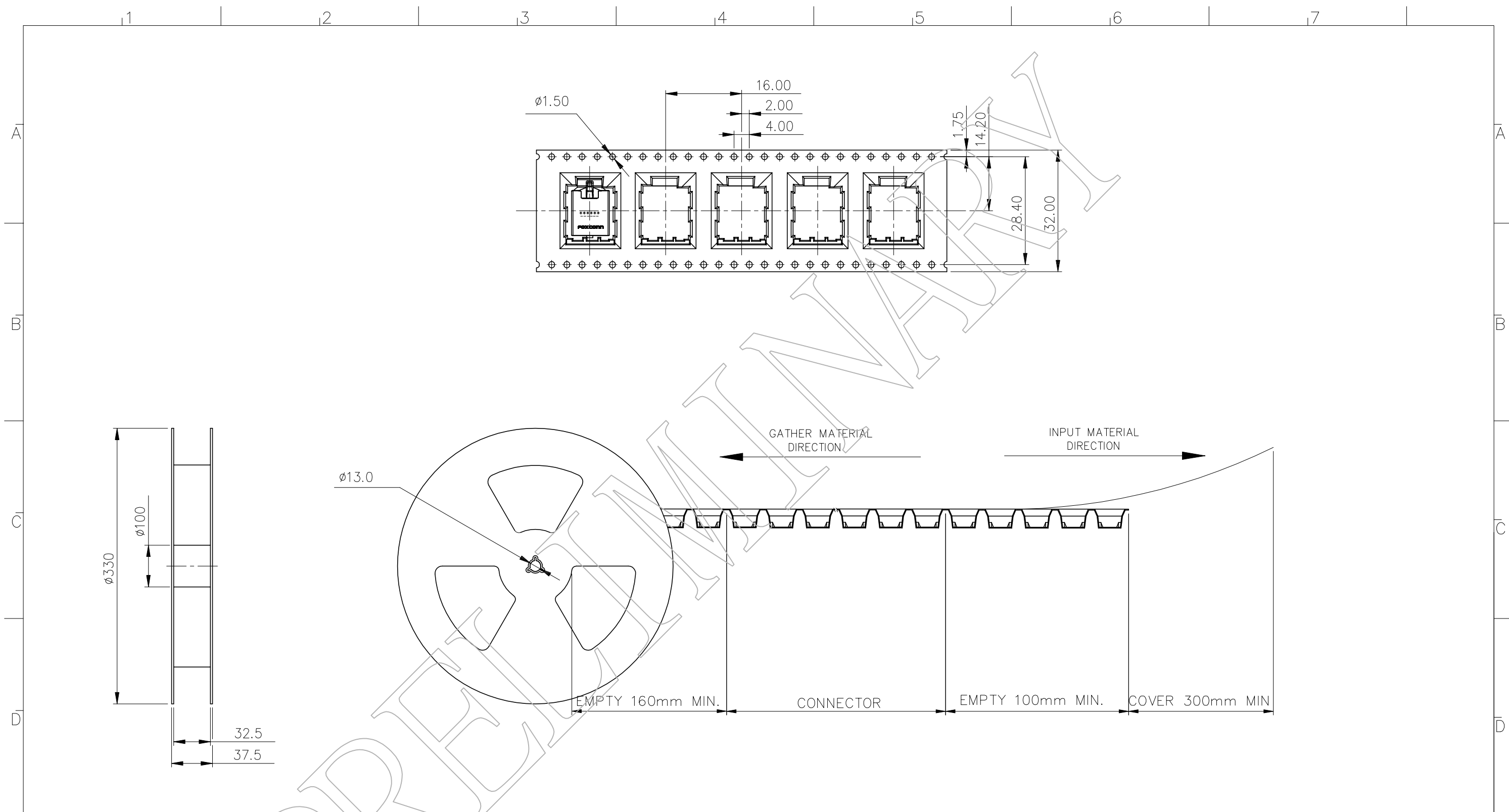

**NOTES**

- 1. CARRIER TAPE MATERIAL: ANTISTATIC PS BLACK
- 2. CARRIER TAPE OPERATING TEMPERATURE: -5°C TO +60°C

P/N	PCS/REEL	REEL/BOX	PCS/BOX	PACKAGE SPEC.
JA634*-40ADA5*-7H	450	6	2700	

X.	X . °	UNITS mm	NAME (INTENDED USE) AUDIO JACK CONNECTOR 4 POLE	<b>FOXCONN®</b> FOXCONN INTERCONNECT TECHNOLOGY LIMITED CLASS: <input type="checkbox"/> CONFIDENTIAL <input type="checkbox"/> SECRET <input checked="" type="checkbox"/> GENERAL						
X ± 0.38	.X °	MAT'L	PART NO. (INTENDED USE) JA634*-40ADA5*-*H							
.XX ± 0.25	.XX °	FINISH	APPD: Shih-wei Hsiao	TITLE: CUSTOMER DRAWING						
.XXX	.XXX°		Q'TY	CHKD: Rex Wang	DWG NO.: 305-0000-5589					
THESE DRAWINGS AND SPECIFICATIONS ARE THE PROPERTY OF FOXCONN INTERCONNECT TECHNOLOGY LIMITED, AND SHALL NOT BE REPRODUCED, COPIED OR USED IN ANY MANNER WITHOUT THE PRIOR WRITTEN CONSENT OF FOXCONN INTERCONNECT TECHNOLOGY LIMITED.			DR: Xuhui Qu 04/29'15	<table border="1"> <tr> <td>SCALE</td> <td>SHEET</td> <td>REV.</td> </tr> <tr> <td>N/A</td> <td>3/4</td> <td>BX4</td> </tr> </table>	SCALE	SHEET	REV.	N/A	3/4	BX4
SCALE	SHEET	REV.								
N/A	3/4	BX4								

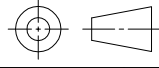

1 2 3 4 5 6 7

A

B

C

D

E

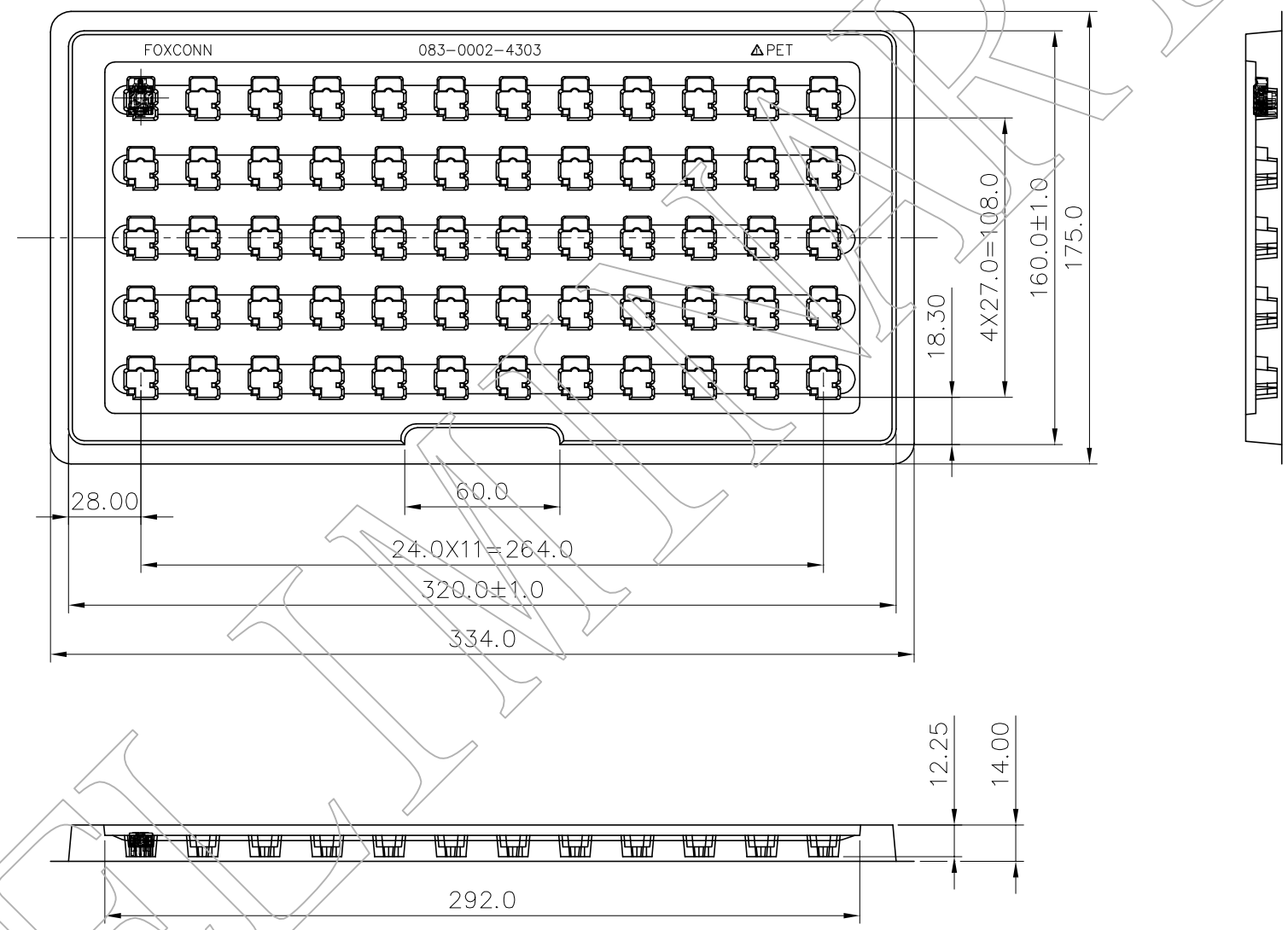

P/N	PCS/TRAY	TRAY/BOX	PCS/BOX	PACKAGE SPEC.
JA634*-40ADA5*-4H	60	36	2160	

X.	x . °	UNITS mm	NAME (INTENDED USE) AUDIO JACK CONNECTOR 4 POLE	<b>FOXCONN®</b> FOXCONN INTERCONNECT TECHNOLOGY LIMITED CLASS: <input type="checkbox"/> CONFIDENTIAL <input type="checkbox"/> SECRET <input checked="" type="checkbox"/> GENERAL						
.X ± 1.0	.X °	MAT'L								
.XX ± 0.5	.XX °	FINISH	PART NO. (INTENDED USE) JA634*-40ADA5*-*H	TITLE: CUSTOMER DRAWING						
.XXX	.XXX°		APPD: Shih-wei Hsiao	DWG NO. : 305-0000-5589						
THESE DRAWINGS AND SPECIFICATIONS ARE THE PROPERTY OF FOXCONN INTERCONNECT TECHNOLOGY LIMITED. AND SHALL NOT BE REPRODUCED, COPIED OR USED IN ANY MANNER WITHOUT THE PRIOR WRITTEN CONSENT OF FOXCONN INTERCONNECT TECHNOLOGY LIMITED.			CHKD: Rex Wang	<table border="1"> <tr> <th>SCALE</th> <th>SHEET</th> <th>REV.</th> </tr> <tr> <td>N/A</td> <td>4/4</td> <td>BX4</td> </tr> </table>	SCALE	SHEET	REV.	N/A	4/4	BX4
			SCALE		SHEET	REV.				
N/A	4/4	BX4								
			DR: Xuhui Qu 04/29'15							

1 2 3 4 5 6 7