

# Specification of MEMS Microphone

**RoHS Compliance & Halogen Free**

**LinkMems P/N: LMA2718T381-OAC02**

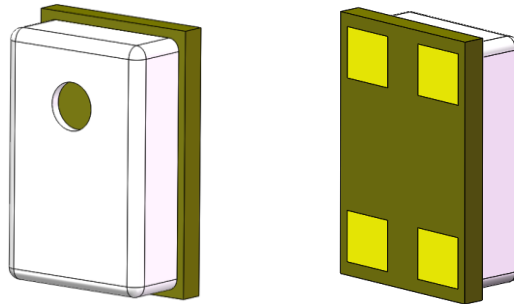

Designed by	Checked by	Approved by
Kevin	Thomas	Hary

Customer Approval

Approved by: \_\_\_\_\_



## Contents

1. Introduction	3
2. Electrical Characteristics	3
3. Frequency Response Curve	4
3.1. Frequency Response Curve	4
3.2. Phase Response Curve	4
4. Test Setup	4
5. Measurement Circuit	5
6. Mechanical Characteristics	5
6.1. Weight	5
6.2. Appearance Drawing	5
7. Application	6
7.1. Pickup Tool Pick Location & PCB Solder Pad Layout	6
7.2. Recommended Reflow Process Condition	6
7.3. Storage Condition	6
8. Packaging	7
8.1. Tape & Reel Specification	7
8.2. Packaging Information	8
9. Reliability Test	9

## MEMS Microphone

### 1. Introduction

The LMA2718T MEMS Microphones are integrated with specialized Pre-amplification ASIC to provide high sensitivity, high SNR output from a capacitive audio sensor. It's packaged for surface mounting and high temperature reflow assembly.

### 2. Electrical Characteristics

Test Condition:  $V_{DD}=2.0V$ ,  $23\pm 2^{\circ}C$ ,  $55\pm 10\%R.H.$ , unless otherwise specified.

Specification	Symbol	Test Conditions	Min.	Typ.	Max.	Unit	
Directivity			Omni-directional				
Sensitivity Range	S	94dB SPL @1kHz	-39	-38	-37	dB	
Output Impedance	$Z_{out}$	94dB SPL @1kHz			300	$\Omega$	
Current Consumption	I				200	$\mu A$	
S/N Ratio	SNR	94dB SPL @1kHz A-Weighted		60		dB(A)	
Operating Voltage	$V_{DD}$		1.6	2.0	3.6	V	
Total Harmonic Distortion	THD	94dB SPL @1kHz		0.1	0.5	%	
Sensitivity Drop	$\Delta S$	94dB SPL @1kHz $V_{DD}=3.6V\sim 1.6V$			0.5	dB	
Acoustic Overload Point	AOP	10% THD @1kHz		127		dB SPL	
Power Supply Rejection	PSR	100mVpp Square wave@217Hz, A-weighted		-100		dB	
Phase Response	PR	94dB SPL, measured in free field and normalized at the average value of the Golden Mics	20Hz	-5		5	deg
			3kHz	-5		5	

### 3. Response Curve

#### 3.1 Frequency Response Curve

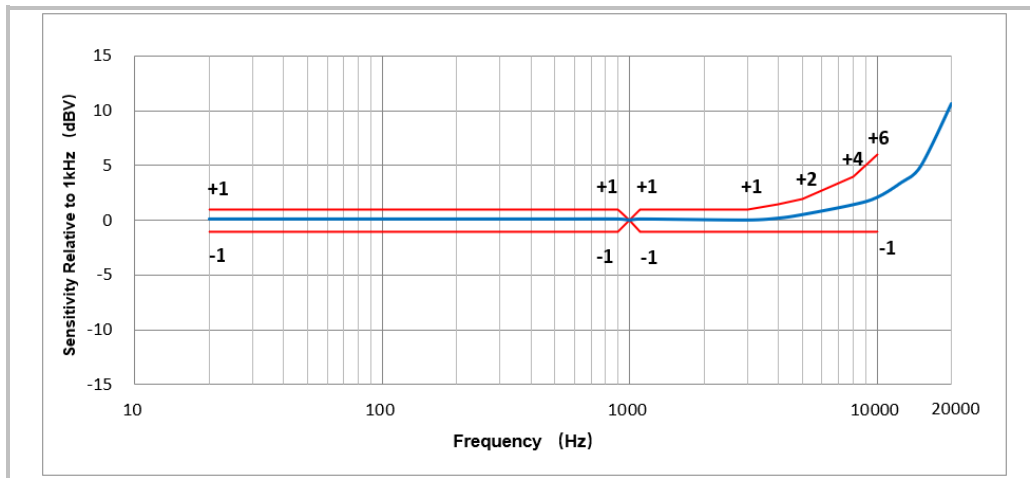

#### 3.2 Phase Response Curve

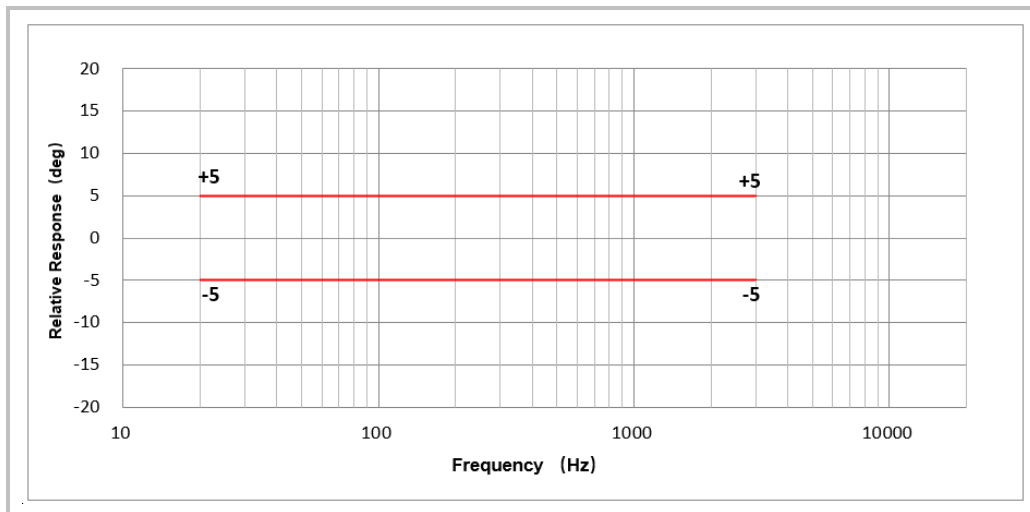

### 4. Test Setup (Sensitivity Test in Anechoic Room)

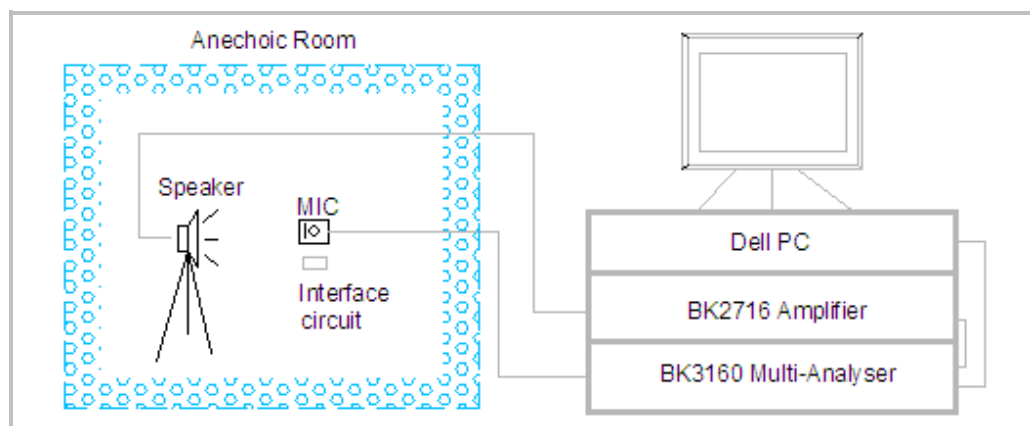

## 5. Measurement Circuit

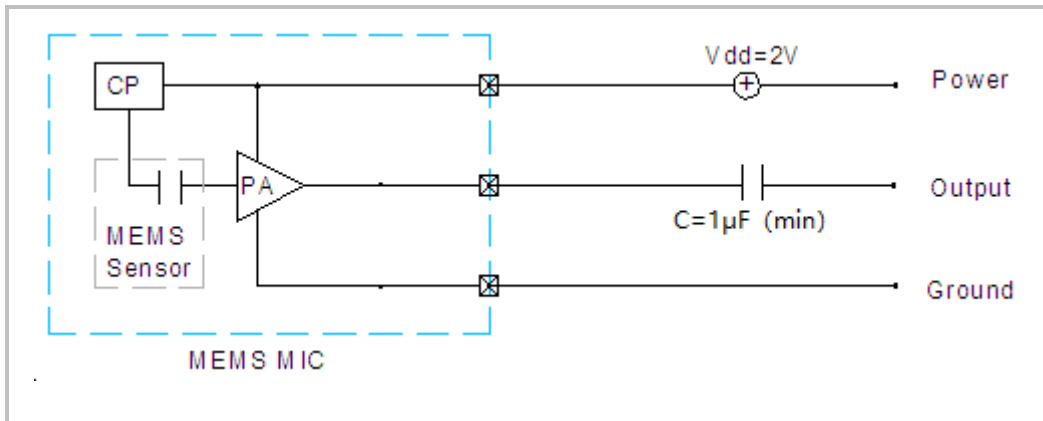

## 6. Mechanical Characteristics

6.1 Weight: Less than 0.03g

6.2 Appearance Drawing(unit: mm)

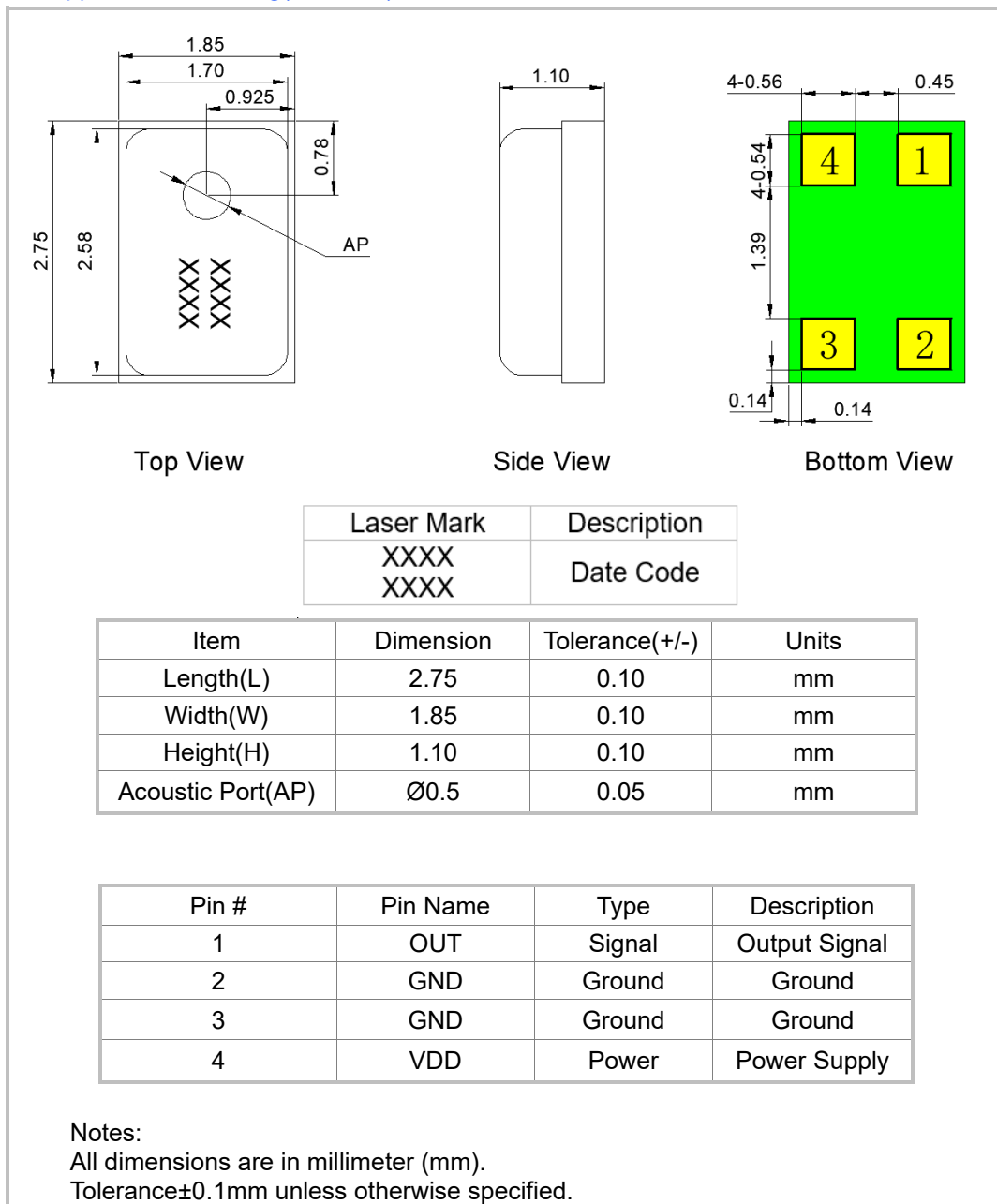

## 7. Application

### 7.1 Pickup Tool Pick Location & PCB Solder Pad Layout

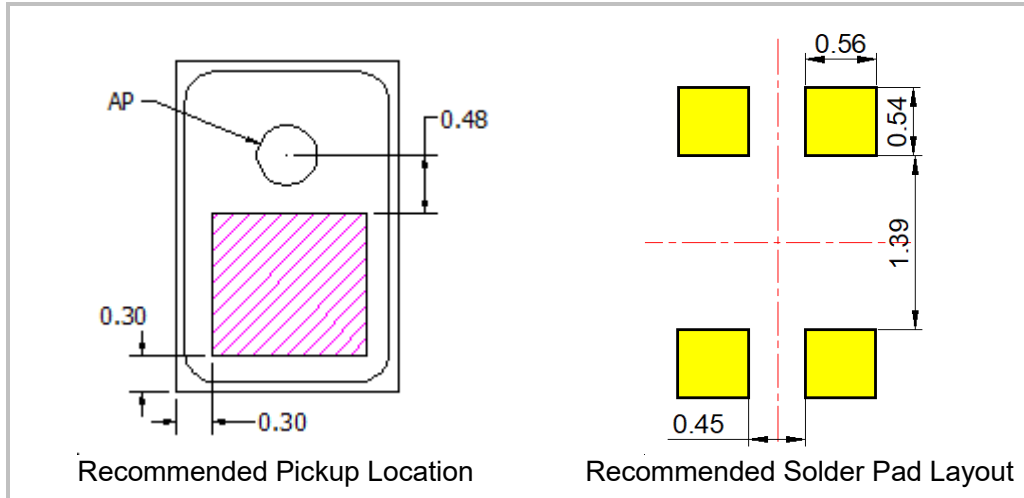

### 7.2 Recommended Reflow Process Condition

Recommend reflow profile, solder reflow  $\leq 260^{\circ}\text{C}$  (for 30s Max of peak temperature).

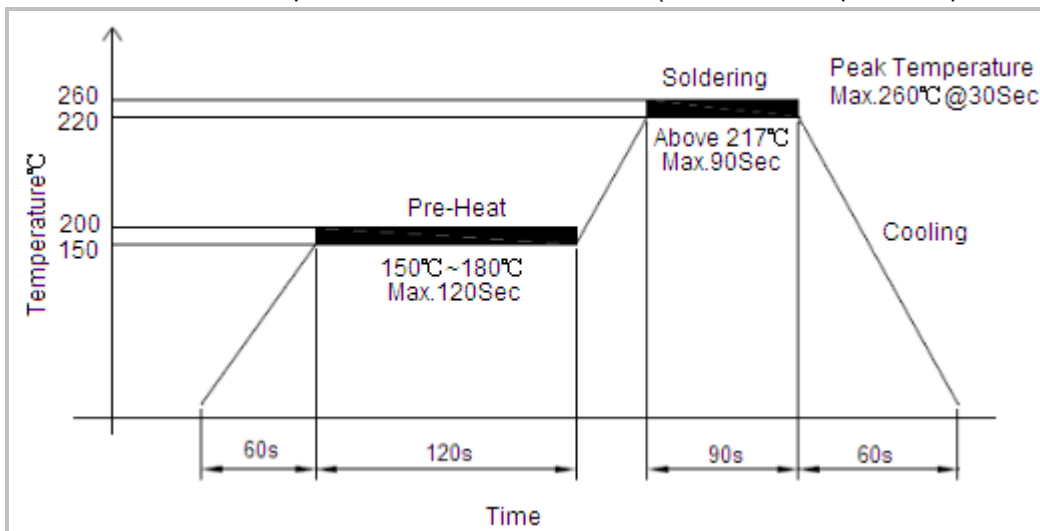

#### Important Notes

In order to minimize device damage:

1. Do not wash or clean the boards after the reflow process.
2. Do not apply the airflow which pressure over 0.3MPa blow into the port hole within a distance of less than 5 cm.
3. Do not exposed to ultrasonic processing or cleaning.
4. Do not pull a vacuum over port hole of the microphone.

### 7.3 Storage Condition

7.3.1 Storage temperature range:-40~+100 $^{\circ}\text{C}$ , and humidity is less than 75%.

7.3.2 Operating temperature range:-40~+85 $^{\circ}\text{C}$ .

7.3.3 MSL (moisture sensitivity Level) is Class 1.

## 8. Packaging

### 8.1 Tape & Reel Specification

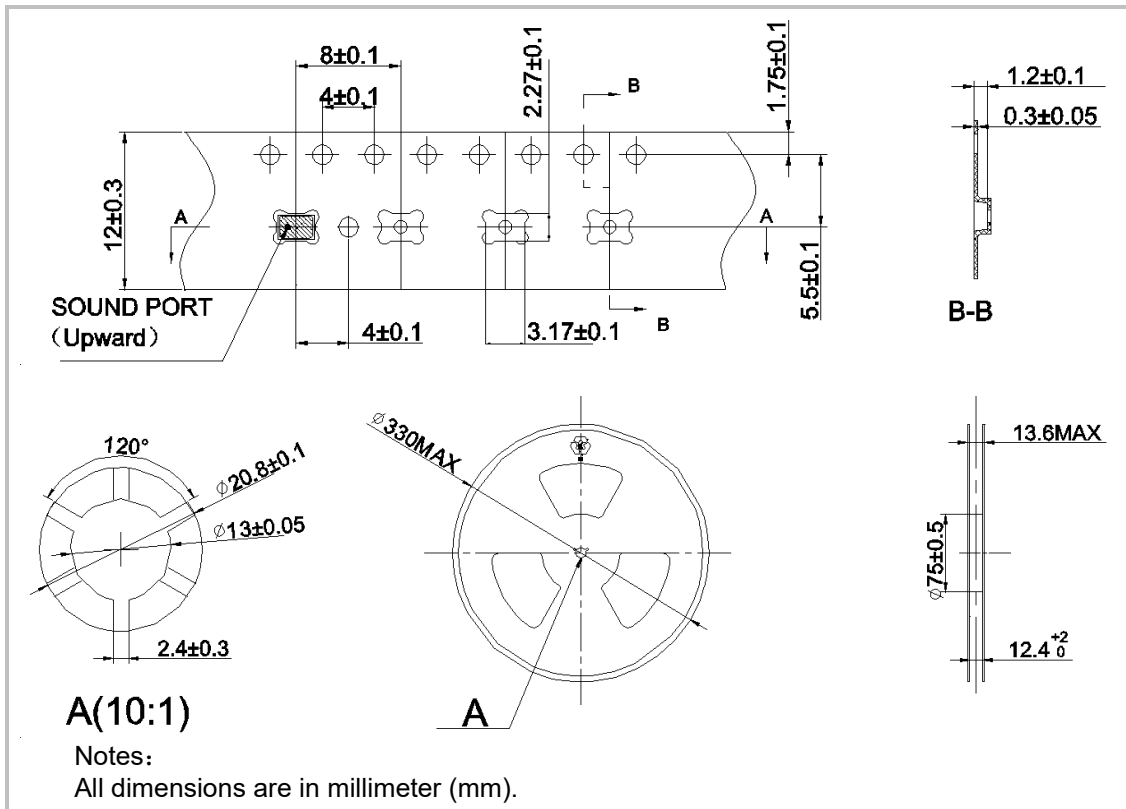

8.2 Packaging Information

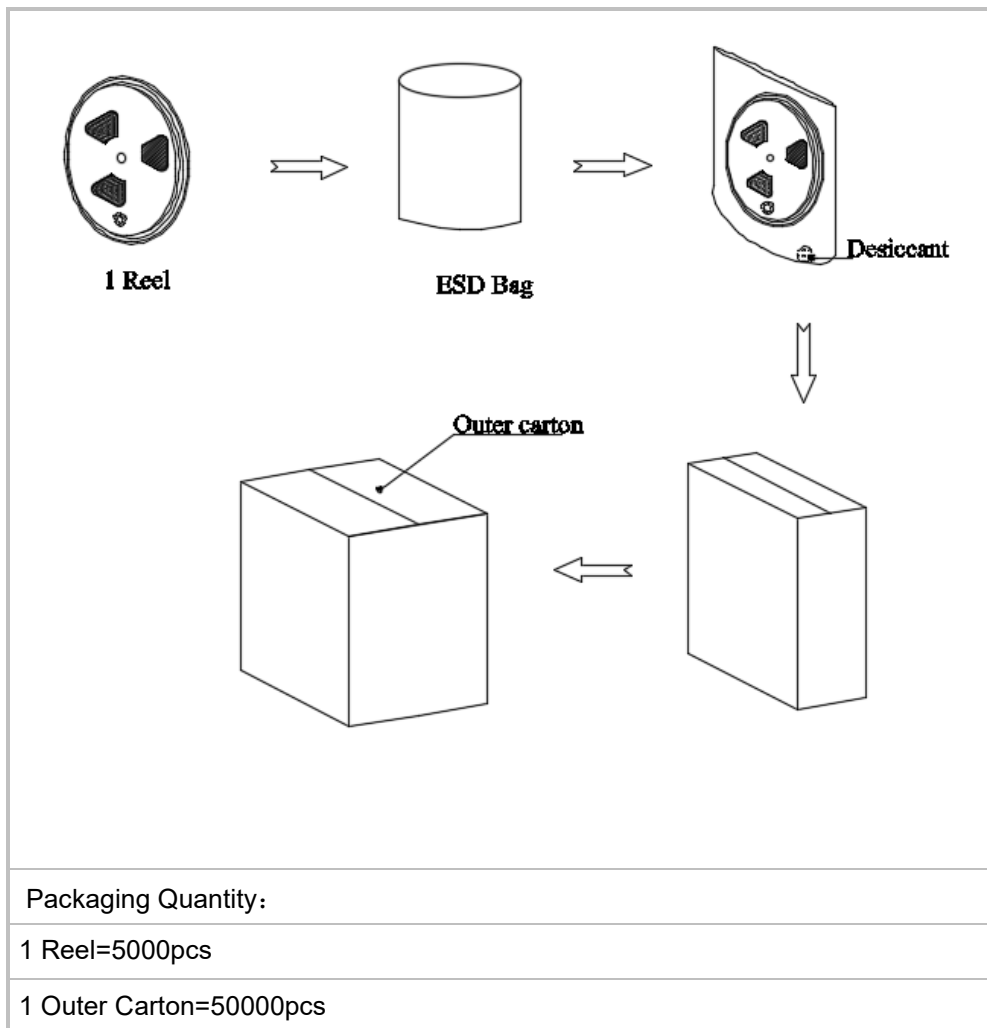



## 9. Reliability Test

The samples should be placed in the room with 23+/-2°C, 55+/-10%R.H. for 2 hours at least before final measurement, unless otherwise specified.

Item	Detail	Standard
Simulated Reflow (Without Solder)	Samples for qualification testing require 3 times 260±5°C reflow solder profiles. 2 hours of setting time is required between each reflow profile test.	±3 dB
Static Humidity	Precondition at +25°C for 1 hour. Then expose to +85°C with 85% relative humidity for 240 hours.	±3 dB
Temperature Shock	Each cycle shall consist of 30 minutes at -40°C, 30 minutes at +125°C with 5 minutes transition time. Test duration is for 30 cycles, starting from cold to hot temperature.	±3 dB
ESD Sensitivity	According to MIL-STD-883G, Method 3015.7 for Human Body Model. Discharge Position: I/O pins Charge Voltage: ±3000V Discharge Network: 100pF & 1500Ω	±3 dB
Random Vibrations	Vibrate randomly along three perpendicular directions for 30 minutes in each direction, 4 cycles from 20Hz~2000Hz with a peak acceleration 20g.	±3 dB
Mechanical Shock	Subject samples to half sine shock pulses (3000g±15% for 0.3ms) in each direction, totally 18 shocks.	±3 dB
High temperature Storage	Microphone unit must maintain sensitivity after storage at +105°C for 240 hours.	±3 dB
Low temperature Storage	Microphone unit must maintain sensitivity after storage at -40°C for 240 hours.	±3 dB
Drop Test	The test was repeated in six directions for 3 times, Dropped from 1.5m height on to a steel surface, total 18 times and inspected for mechanical damage.	±3 dB

## Specification Revisions

Revision	Description	Approved	Date
1.0	New Version Released	Hary	28/07/2023