

修 订 REV NO	标 记 MARK	修 改 描 要 REVISION DESCRIPTION	签 名 SIGNATURE	日 期 DATE
		NEW DWG		2016-03-12

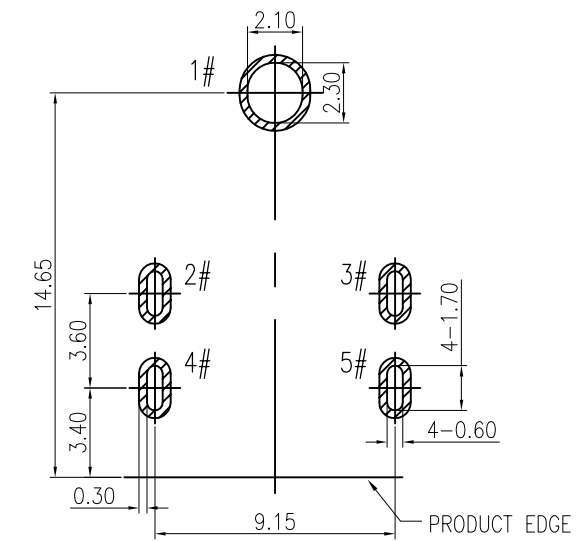

RECOMMENDED PCB LAYOUT
TOP VIEW TOLERANCE: ±0.05

- SPECIFICATION:
- RATING: DC 30V 20A
 - CONTACT RESISTANCE:
30mΩ MAX(INITIAL).
50mΩ MAX(FINAL).
 - INSULATION RESISTANCE: 100 MΩ MIN.
 - WITHSTAND VOLTAGE: 500 VAC
 - INSERTION FORCE: 30N MAX.
 - EXTRACTION FORCE: 3N MIN.
 - DURABILITY: 5,000 CYCLES

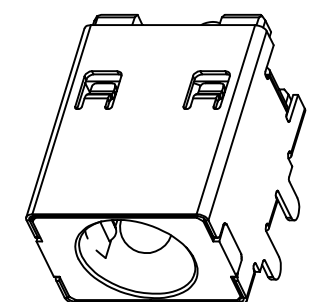
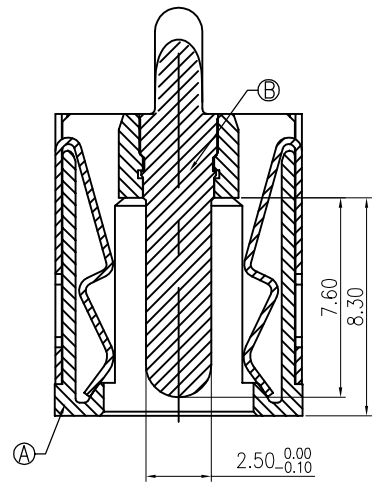
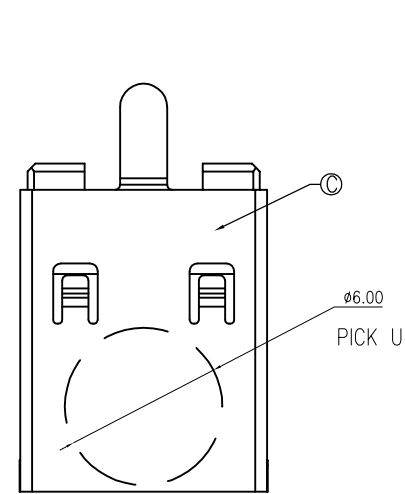
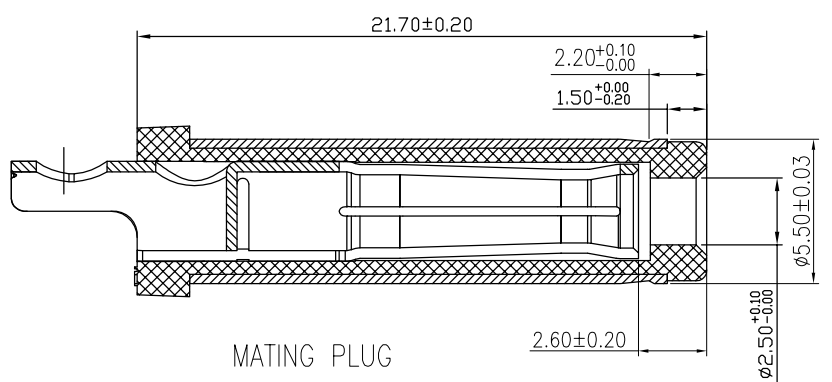
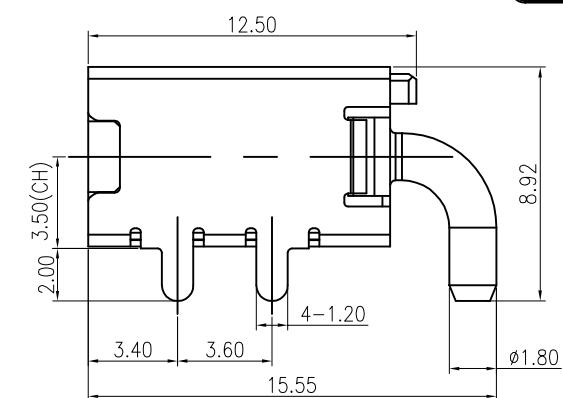
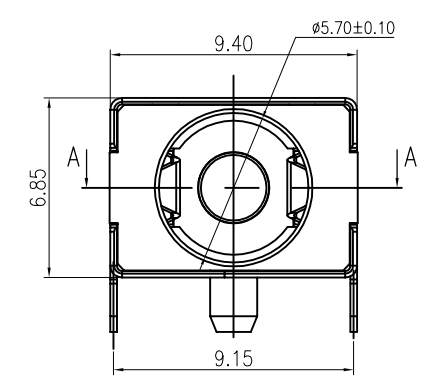
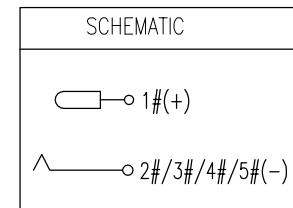

MATING PLUG
DP550250-0188-6H

C	SHELL	C5210	Ni 40u" MIN.	1
B	CENTER PIN	BRASS	GOLD FLASH /Ni 40u" MIN.	1
A	HOUSING	PA10T	BLACK	1
NO.	DESCRIPTION	MATERIAL	REMARKS	QTY

深圳市华德共创科技有限公司
Shenzhen Huade co-create Technology Co.,LTD
电话: 0755-23304126 传真: 0755-29940187

-TOLERANCES- UNLESS OTHERWISE SPECIFIED 公差参数表			TITLE: DC Power Jack 5525 大电流20A, 卧 产品名称: 式, 高可靠 板上型四脚插板			
X.X	±0.30	X.X*	±3°	APPD: 核准:	PART NO: 产品编号: DC550250-1195-2H	
X.XX	±0.20	X.XX*	±2°	CHECK: 校对: 王建业	DATE	SCALE UNIT CODE NUMBER
X.XXX	±0.10	X.XXX*	±1°	DRAW: 绘图: 黄艳兰	2016-03-12	1:1 mm A001