

Product Summary

- $V_{DS} = -20V, I_D = -3A$
 $R_{DS(ON)} < 140m\Omega @ V_{GS} = -2.5V$
 $R_{DS(ON)} < 110m\Omega @ V_{GS} = -4.5V$
- Package SOT-23

Application

- Battery protection
- Load switch
- Power management

Package and Pin Configuration



Marking:302D

Circuit diagram

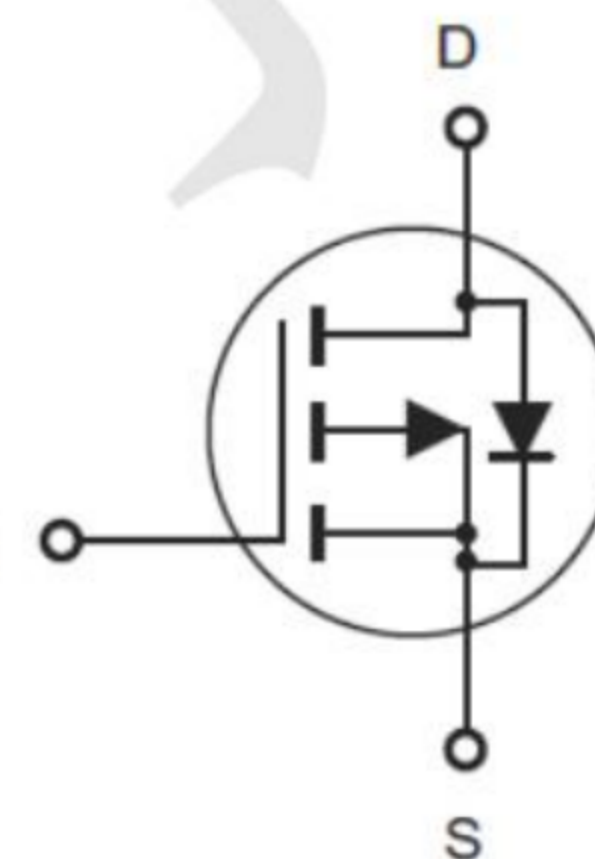

Absolute Maximum Ratings ($T_A = 25^\circ C$ unless otherwise noted)

Parameter	Symbol	Limit	Unit
Drain-Source Voltage	V_{DS}	-20	V
Gate-Source Voltage	V_{GS}	± 12	V
Drain Current-Continuous	I_D	-3	A
Drain Current -Pulsed ^(Note 1)	I_{DM}	-10	A
Maximum Power Dissipation	P_D	1	W
Operating Junction and Storage Temperature Range	T_J, T_{STG}	-55 To 150	$^\circ C$

Thermal Characteristic

Thermal Resistance, Junction-to-Ambient ^(Note 2)	$R_{\theta JA}$	125	$^\circ C/W$
---	-----------------	-----	--------------

Electrical Characteristics (T_A=25°C unless otherwise noted)

Parameter	Symbol	Condition	Min	Typ	Max	Unit
Off Characteristics						
Drain-Source Breakdown Voltage	BV _{DSS}	V _{GS} =0V, I _D =-250μA	-20	-24	-	V
Zero Gate Voltage Drain Current	I _{DSS}	V _{DS} =-20V, V _{GS} =0V	-	-	-1	μA

Parameter	Symbol	Condition	Min	Typ	Max	Unit
Gate-Body Leakage Current	I _{GSS}	V _{GS} =±12V, V _{DS} =0V	-	-	±100	nA
On Characteristics (Note 3)						
Gate Threshold Voltage	V _{GS(th)}	V _{DS} =V _{GS} , I _D =-250μA	-0.4	-0.7	-1	V
Drain-Source On-State Resistance	R _{DS(ON)}	V _{GS} =-4.5V, I _D =-3A	-	64	110	mΩ
		V _{GS} =-2.5V, I _D =-2A	-	89	140	mΩ
Forward Transconductance	g _{FS}	V _{DS} =-5V, I _D =-2A	5	-	-	S
Dynamic Characteristics (Note 4)						
Input Capacitance	C _{iss}	V _{DS} =-10V, V _{GS} =0V, F=1.0MHz	-	405	-	PF
Output Capacitance	C _{oss}		-	75	-	PF
Reverse Transfer Capacitance	C _{rss}		-	55	-	PF
Switching Characteristics (Note 4)						
Turn-on Delay Time	t _{d(on)}	V _{DD} =-10V, I _D =-1A V _{GS} =-4.5V, R _{GEN} =10Ω	-	11	-	nS
Turn-on Rise Time	t _r		-	35	-	nS
Turn-Off Delay Time	t _{d(off)}		-	30	-	nS
Turn-Off Fall Time	t _f		-	10	-	nS
Total Gate Charge	Q _g	V _{DS} =-10V, I _D =-3A, V _{GS} =-2.5V	-	3.3	12	nC
Gate-Source Charge	Q _{gs}		-	0.7	-	nC
Gate-Drain Charge	Q _{gd}		-	1.3	-	nC
Drain-Source Diode Characteristics						
Diode Forward Voltage (Note 3)	V _{SD}	V _{GS} =0V, I _S =1.3A	-	-	-1.2	V
Diode Forward Current (Note 2)	I _S		-	-	-3	A

Typical Electrical and Thermal Characteristics

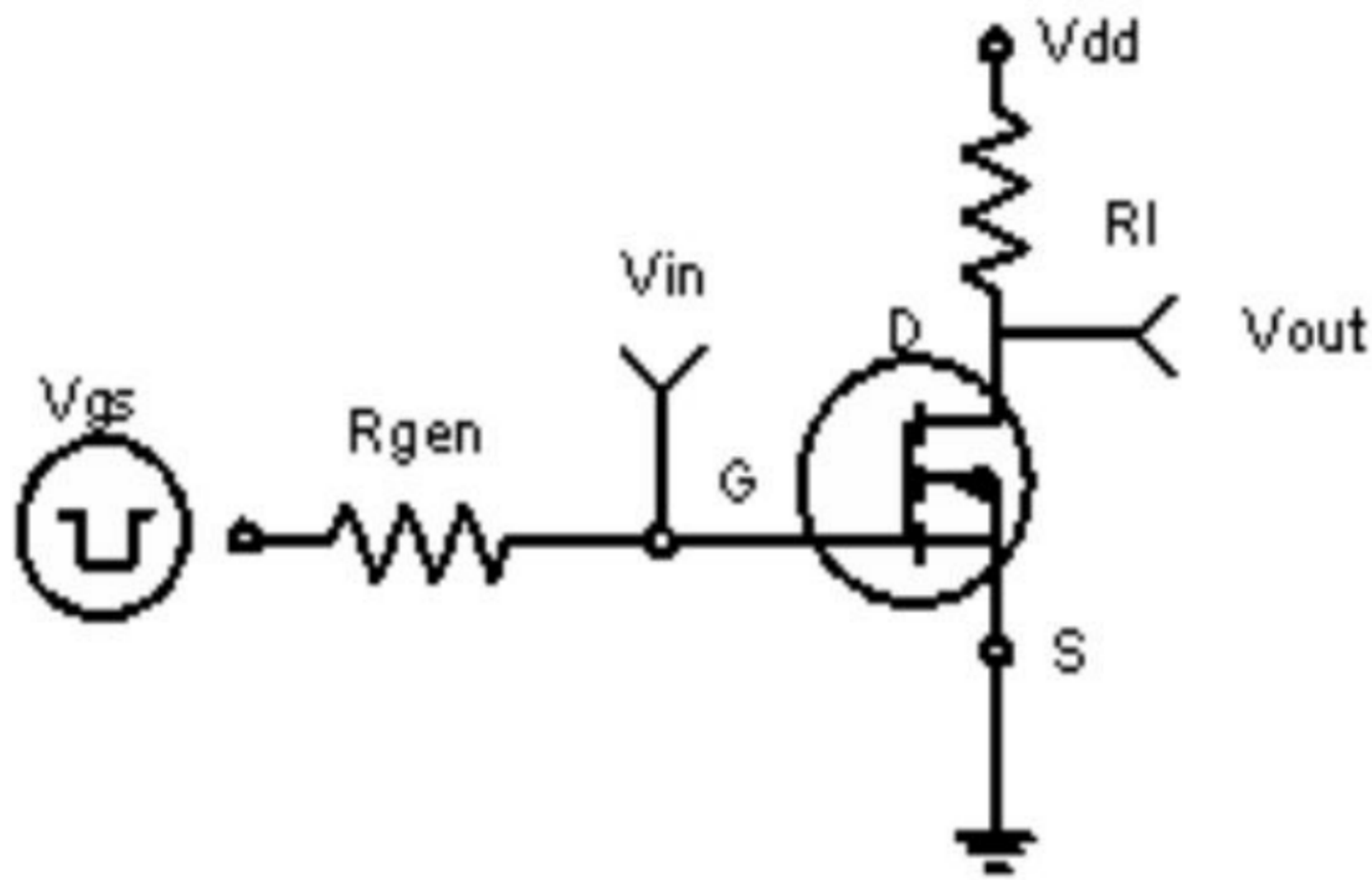

Figure 1: Switching Test Circuit

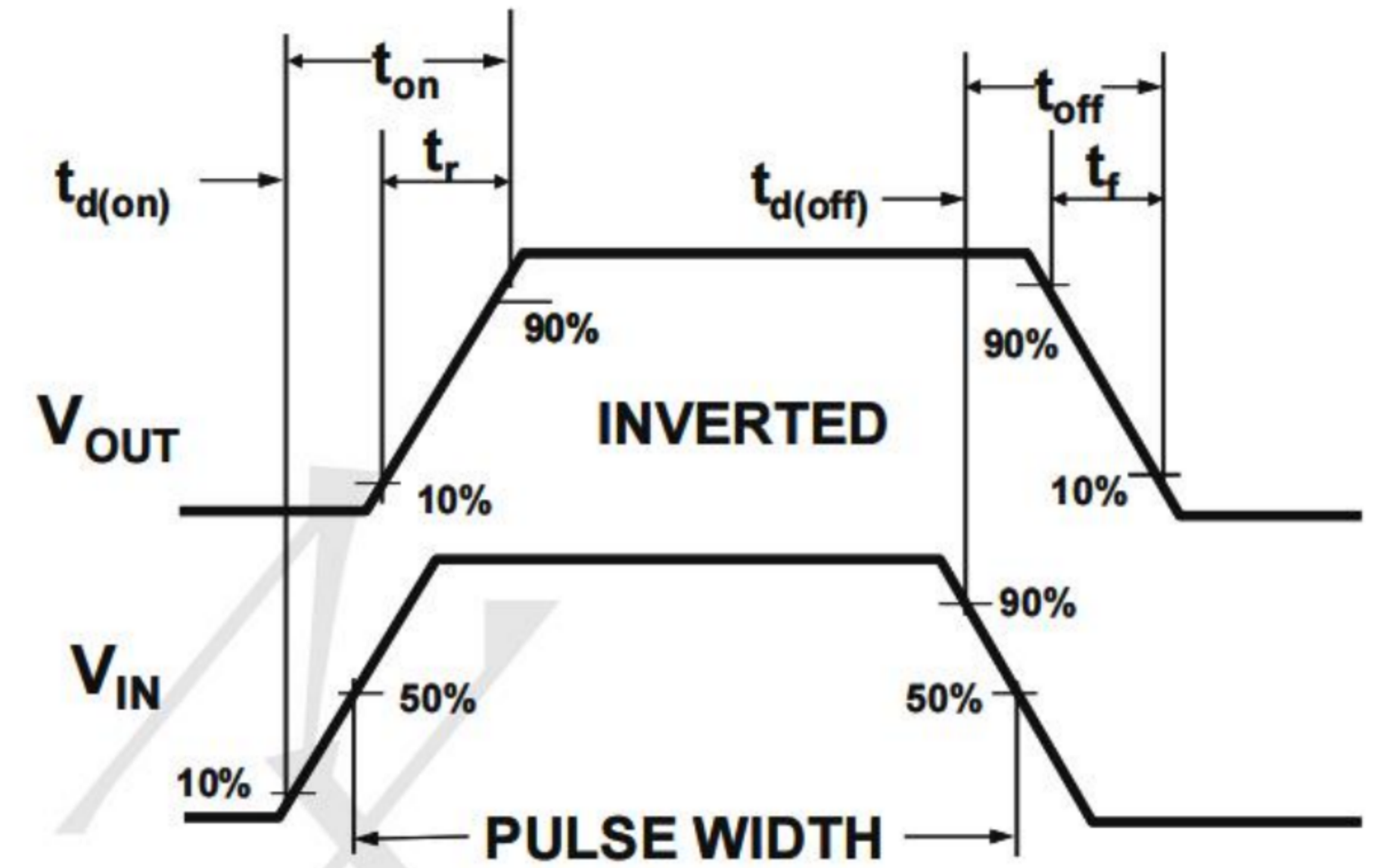
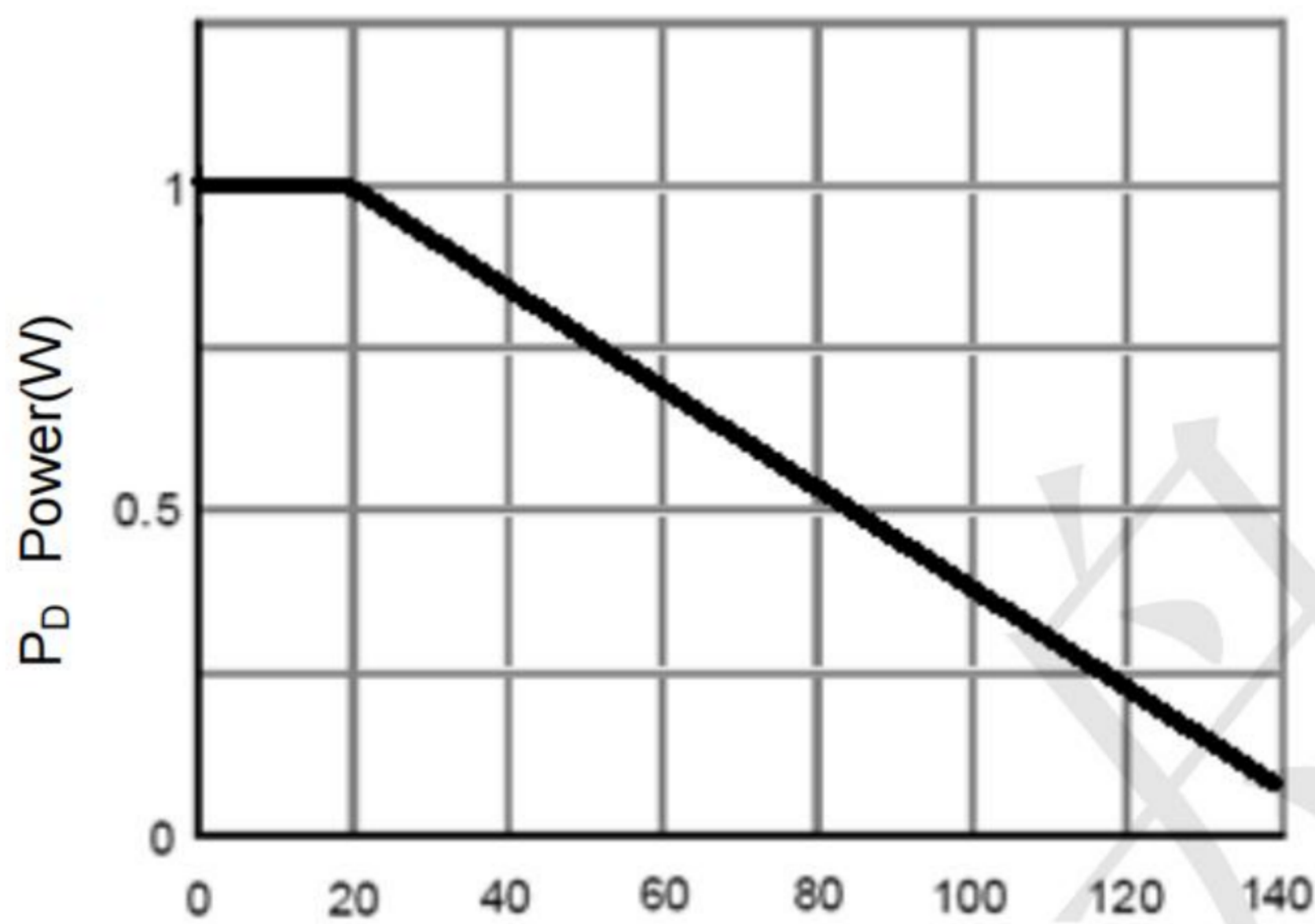
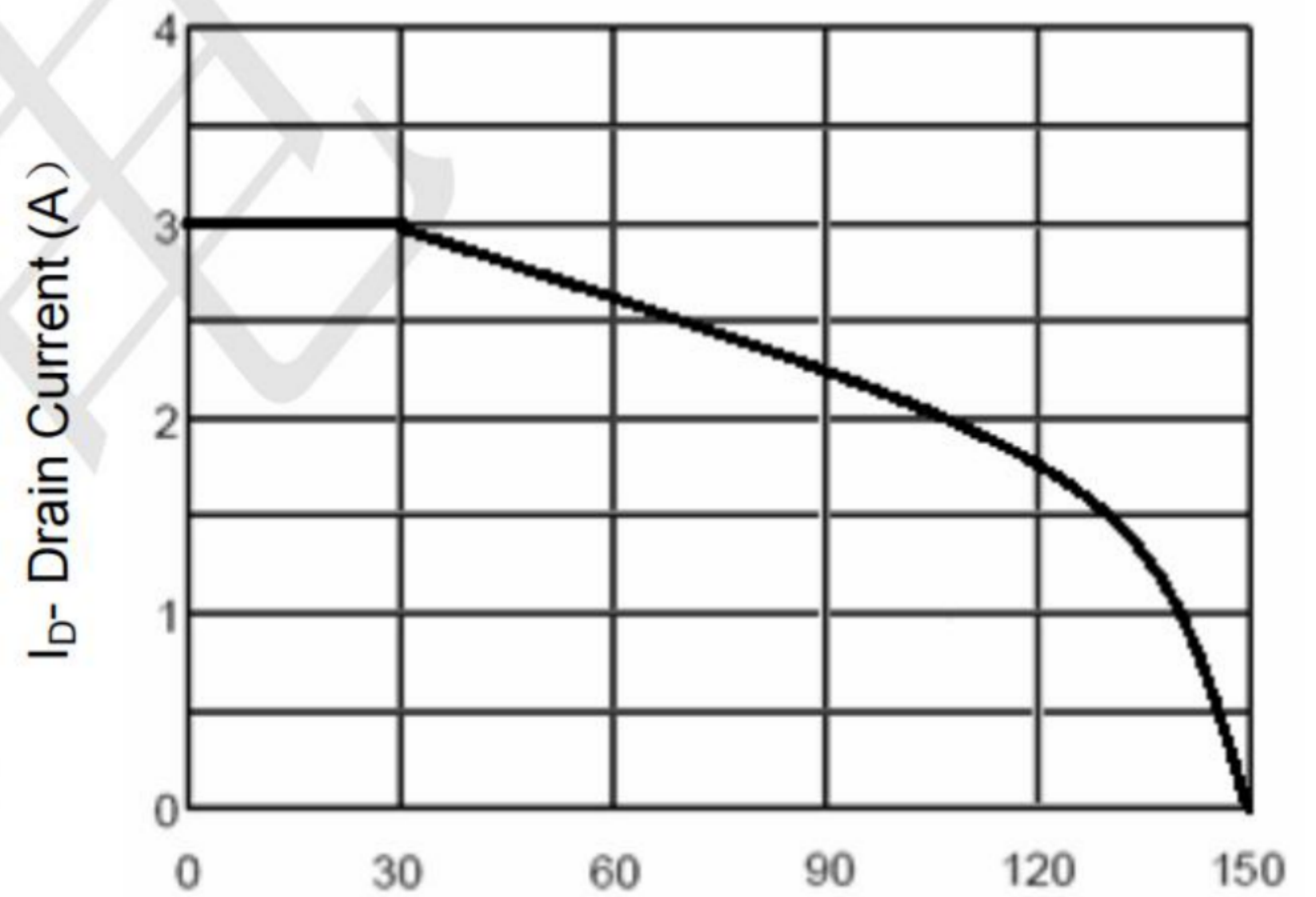

Figure 2: Switching Waveforms



T_J-Junction Temperature (°C)
Figure 3 Power Dissipation



T_J-Junction Temperature (°C)
Figure 4 Drain Current

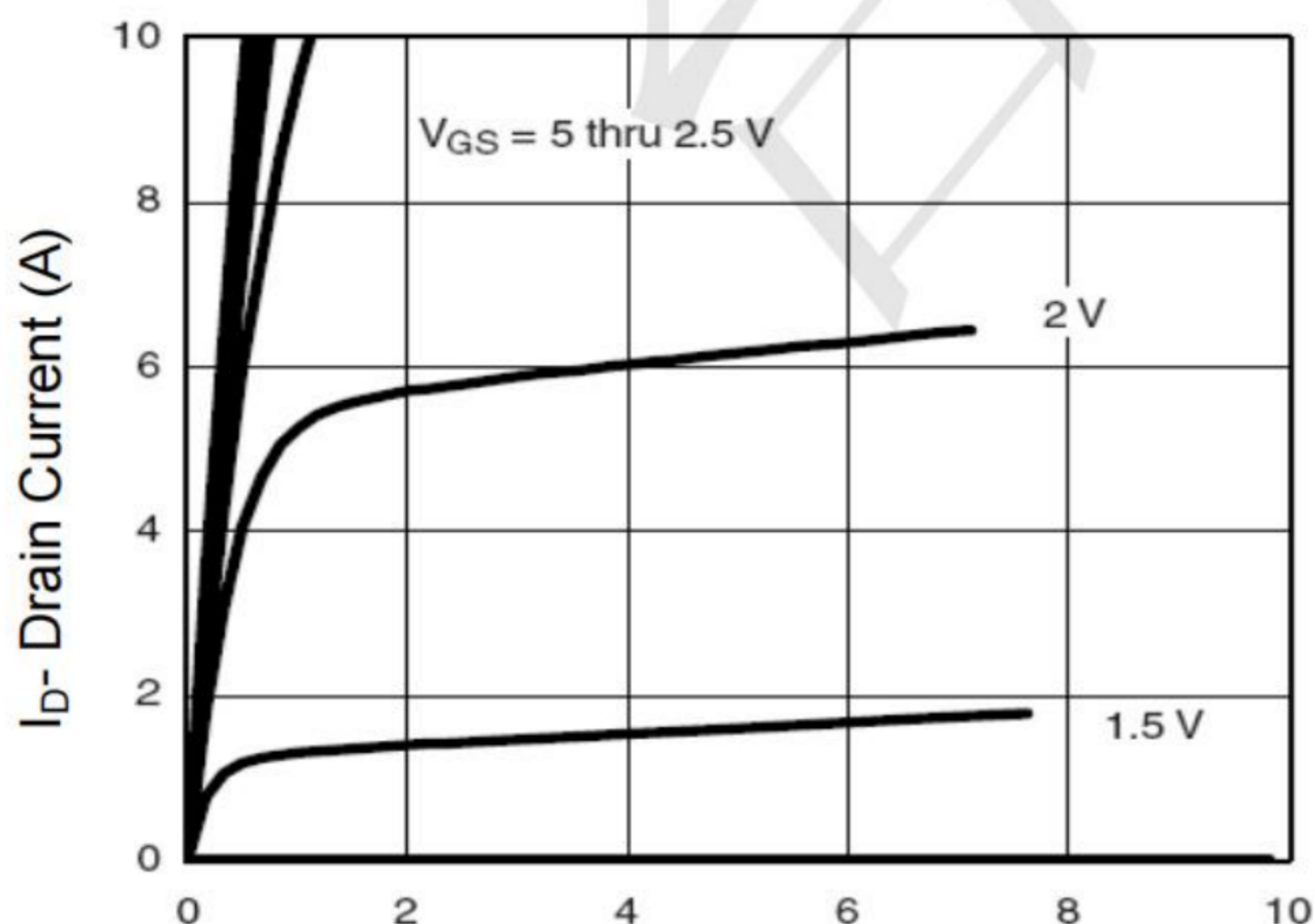

V_{ds} Drain-Source Voltage (V)
Figure 5 Output Characteristics

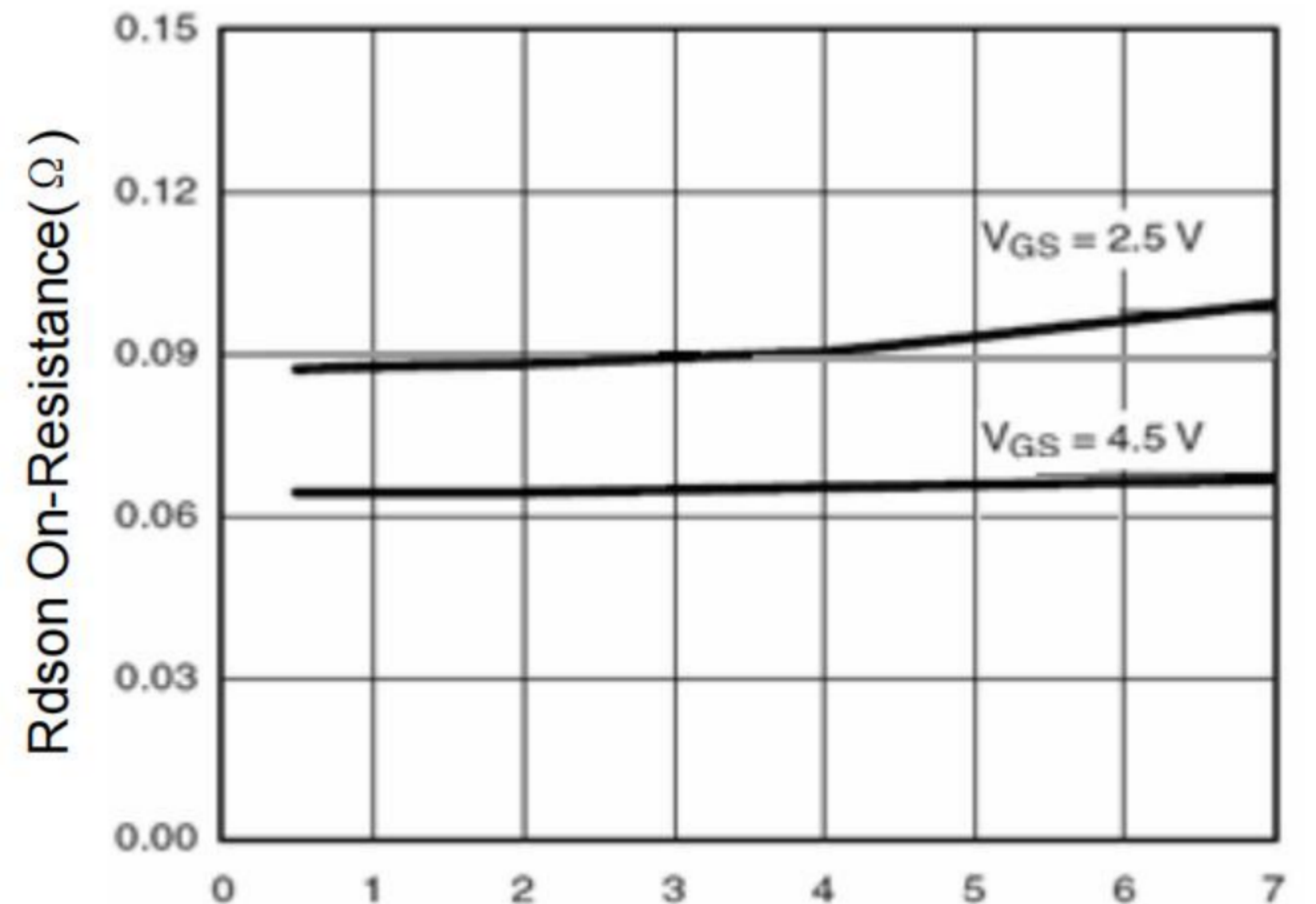

I_D- Drain Current (A)
Figure 6 Drain-Source On-Resistance

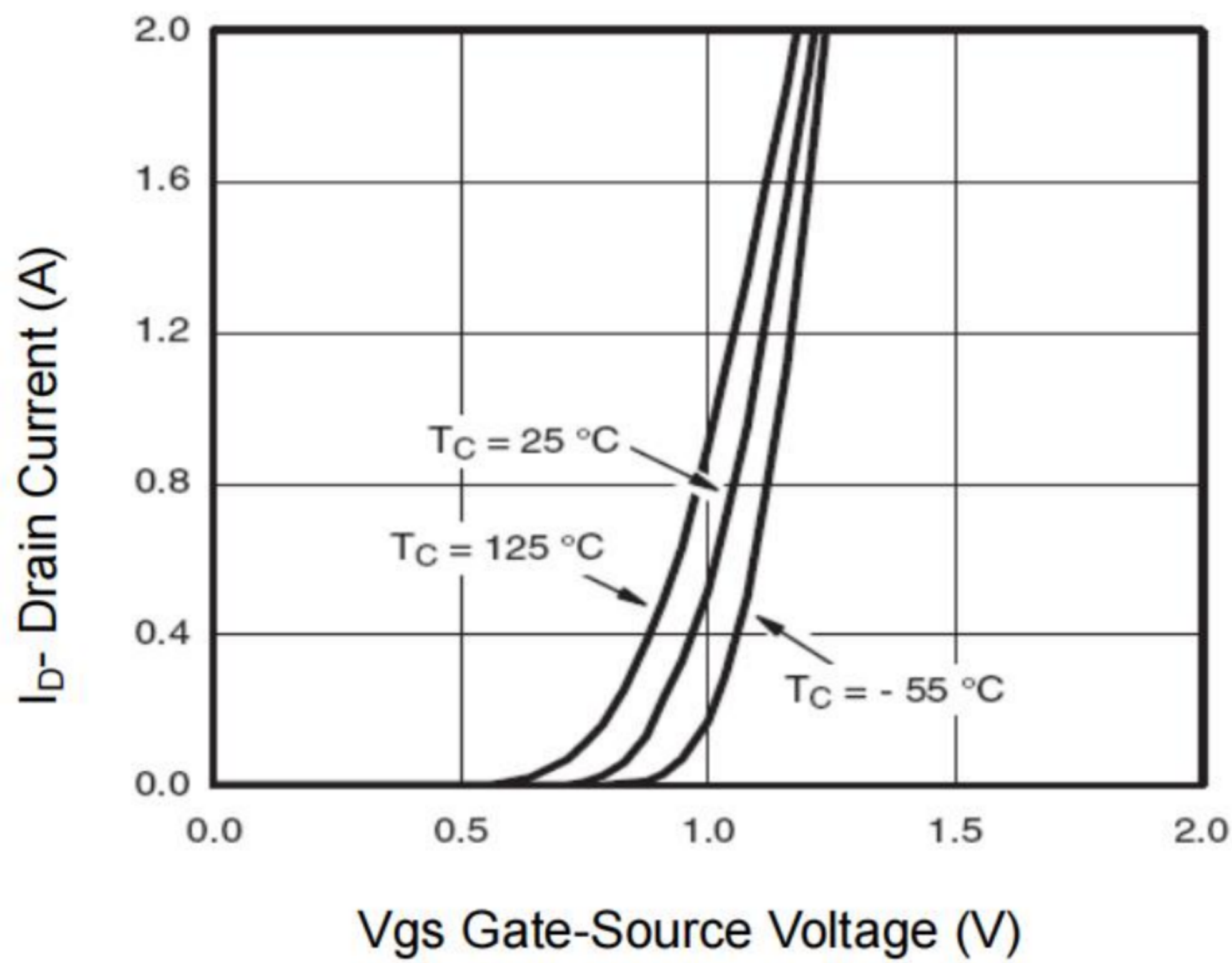

Figure 7 Transfer Characteristics

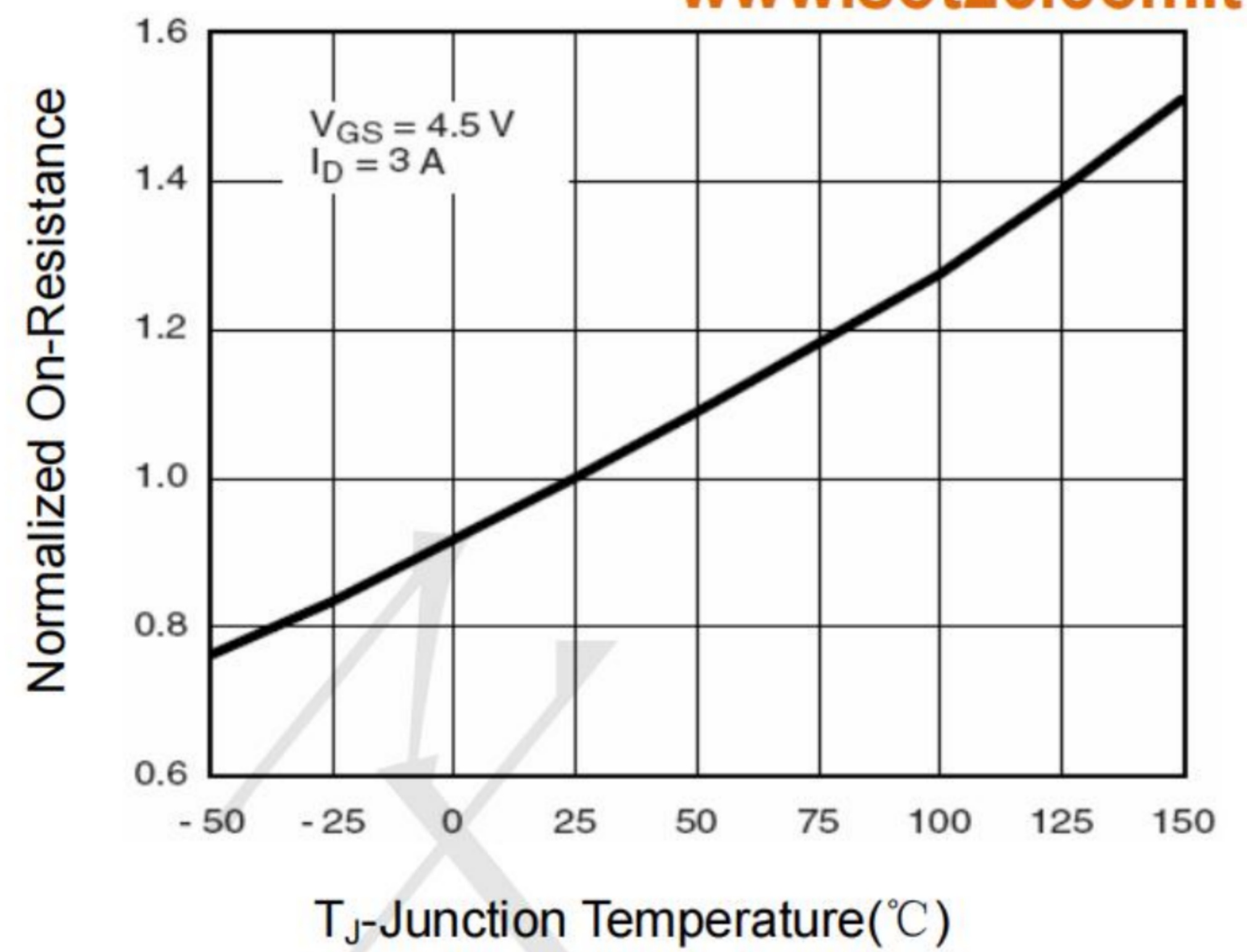

Figure 8 Drain-Source On-Resistance

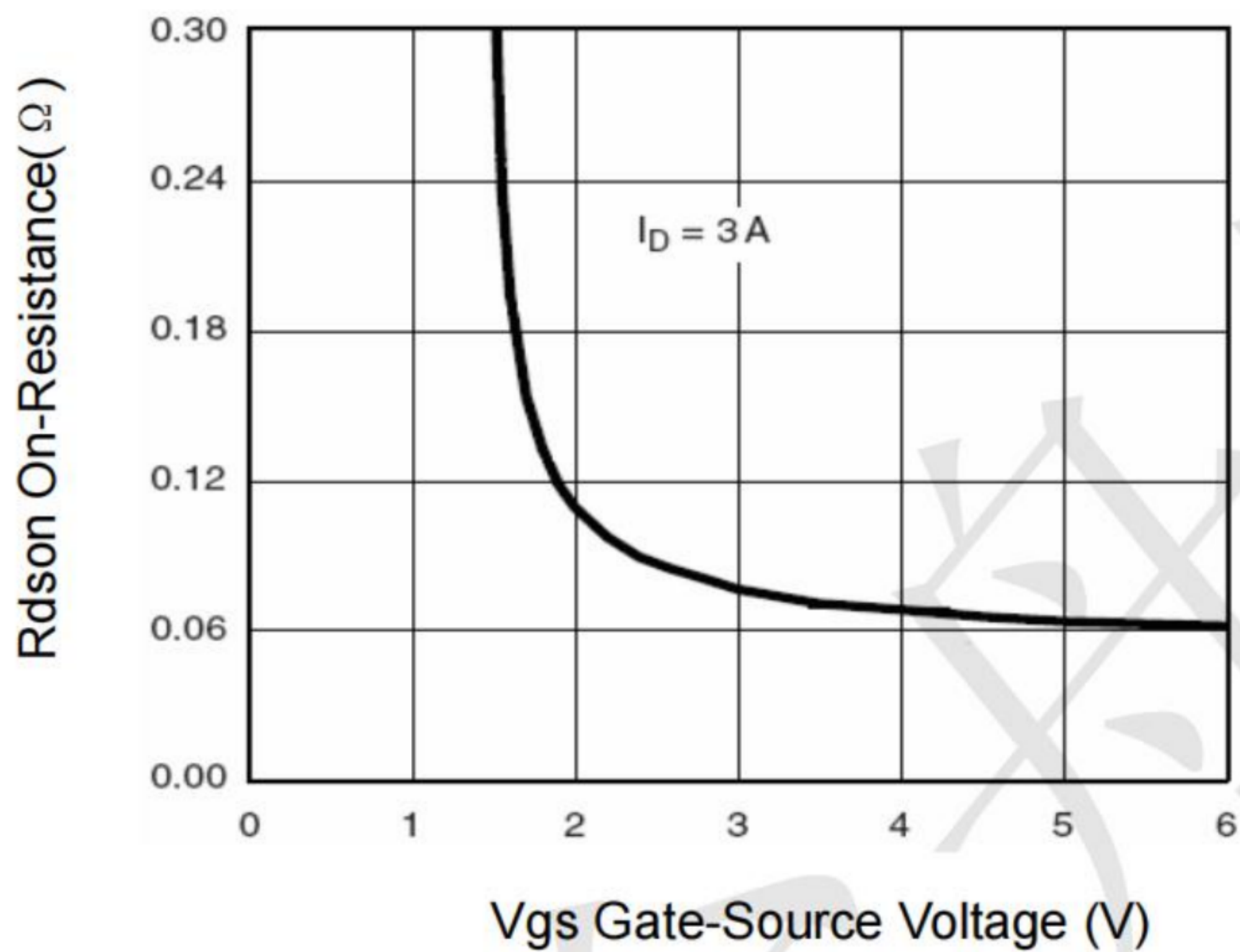

Figure 9 Rdson vs Vgs

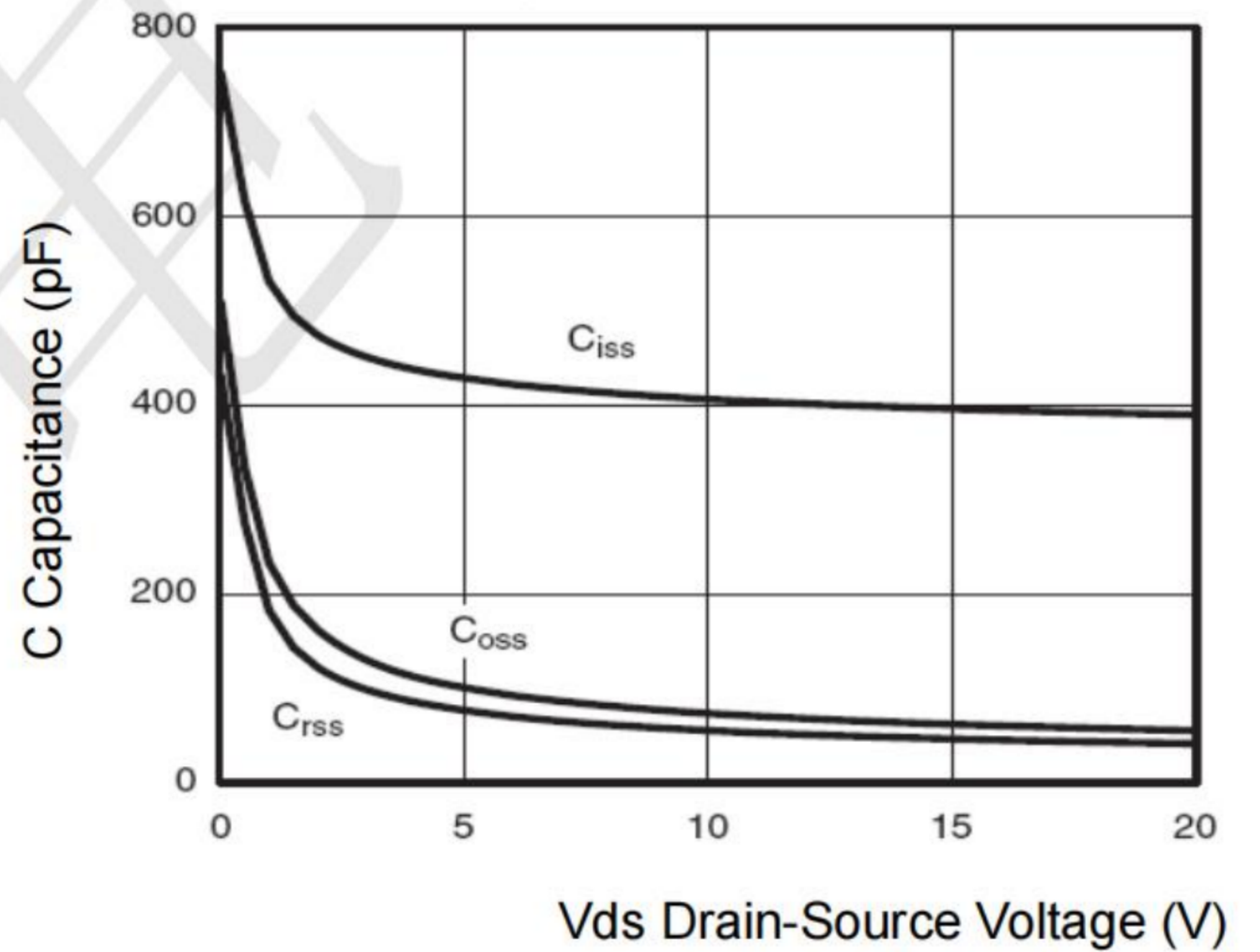

Figure 10 Capacitance vs Vds

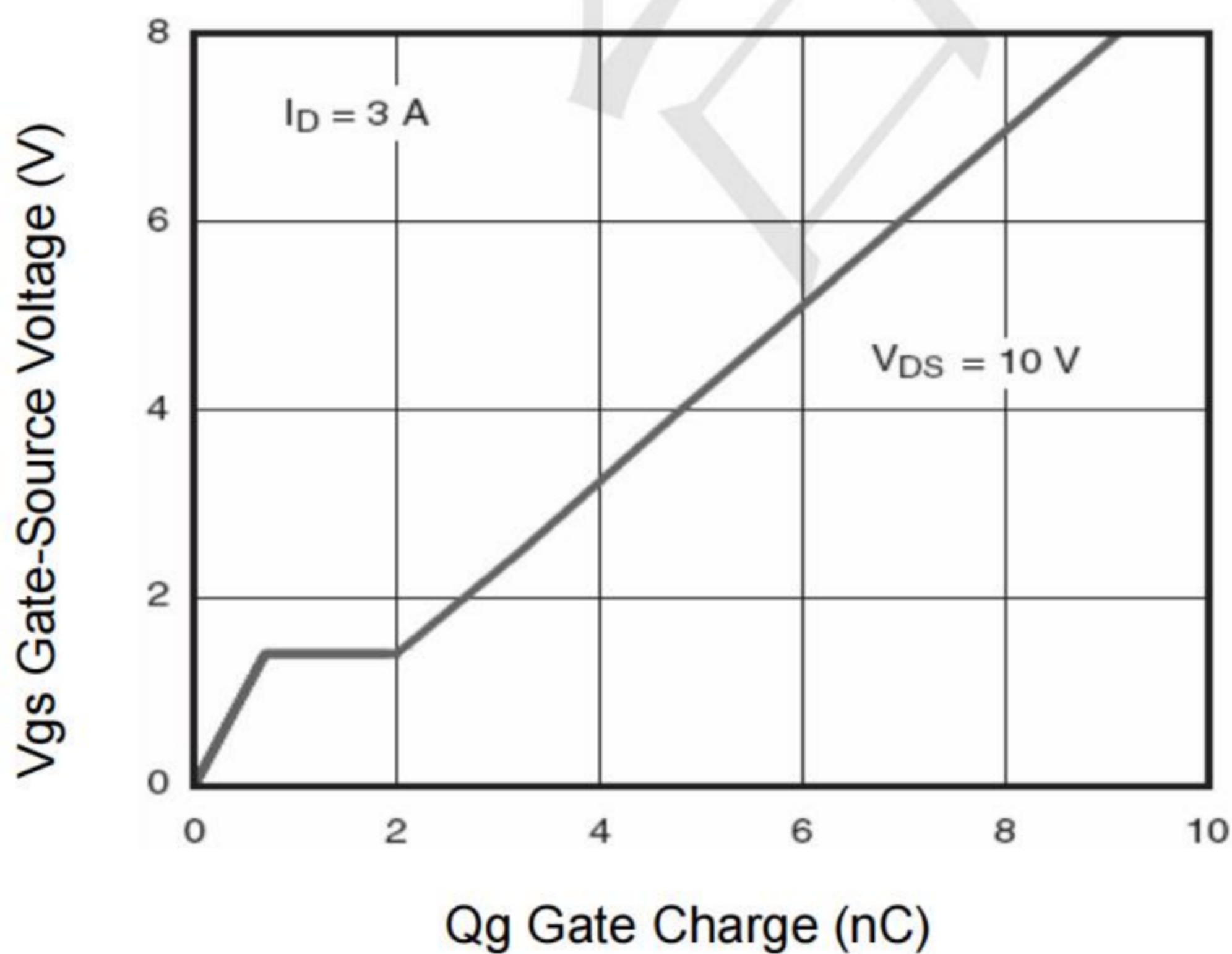

Figure 11 Gate Charge

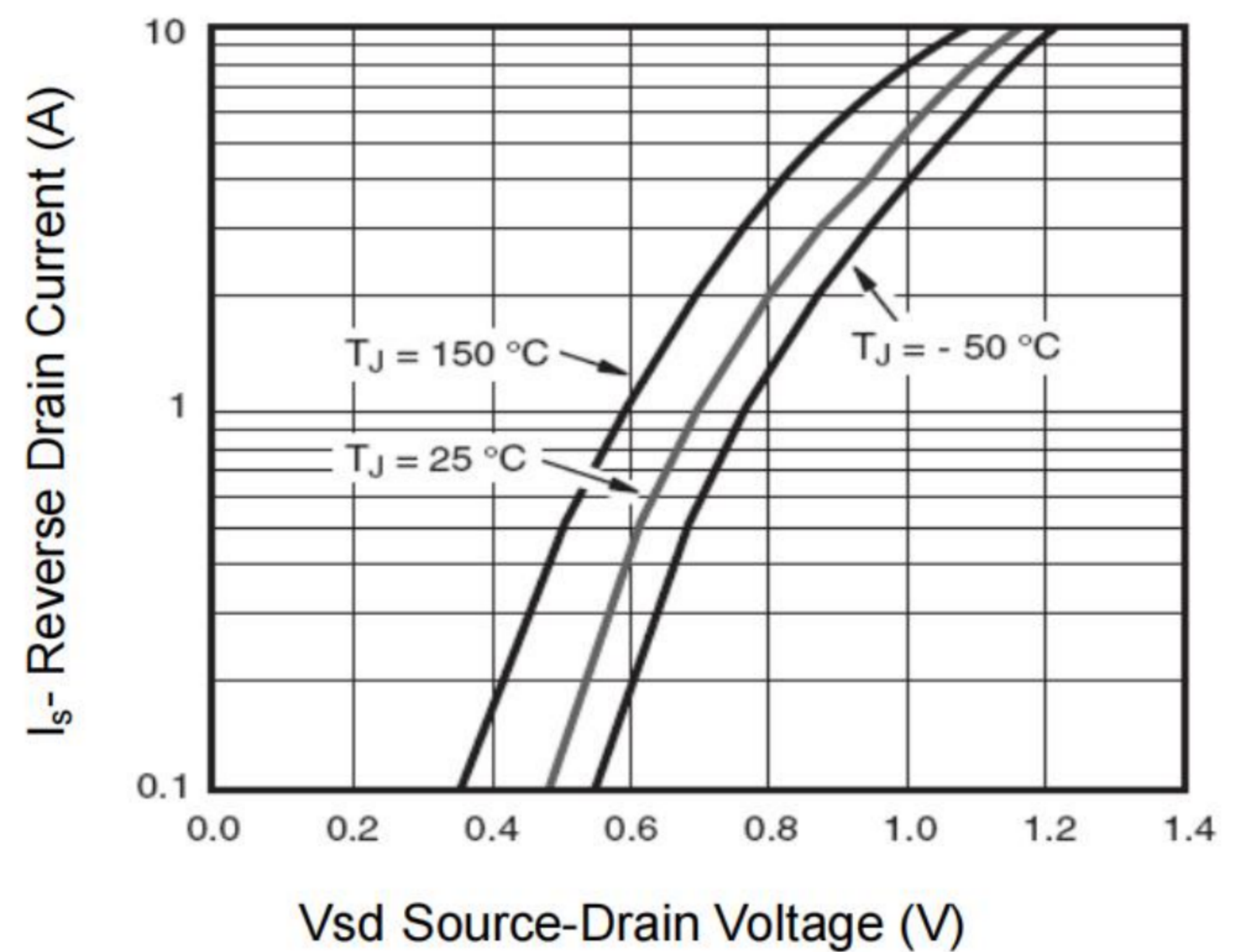

Figure 12 Source- Drain Diode Forward

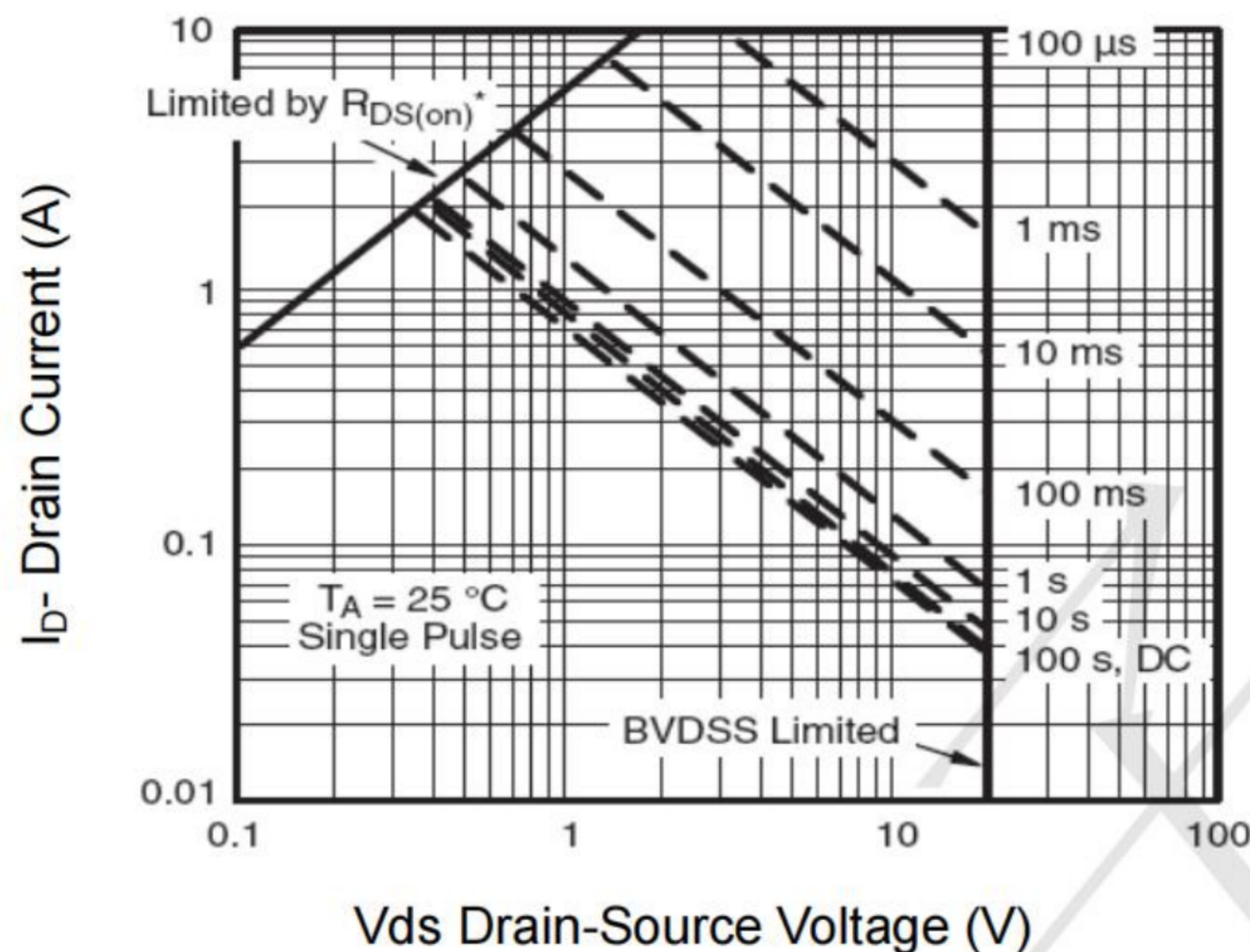

Figure 13 Safe Operation Area

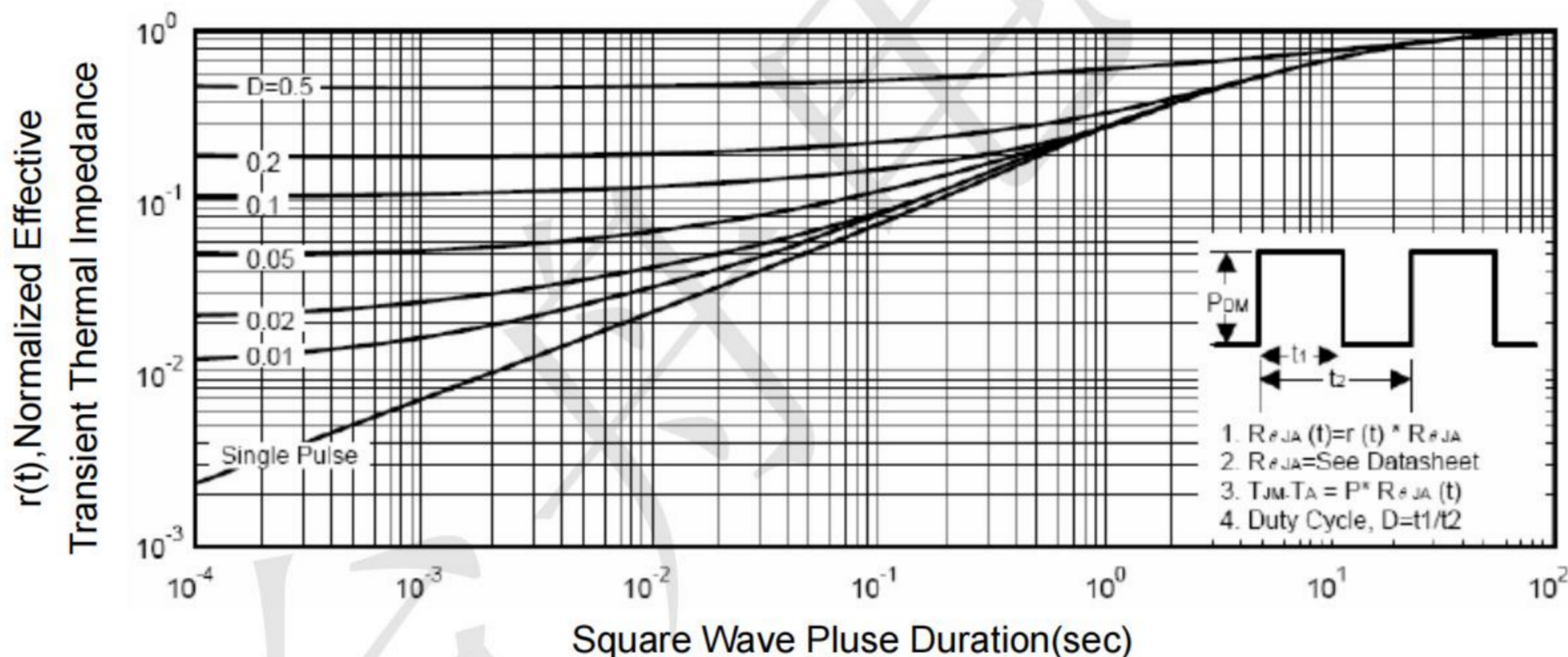
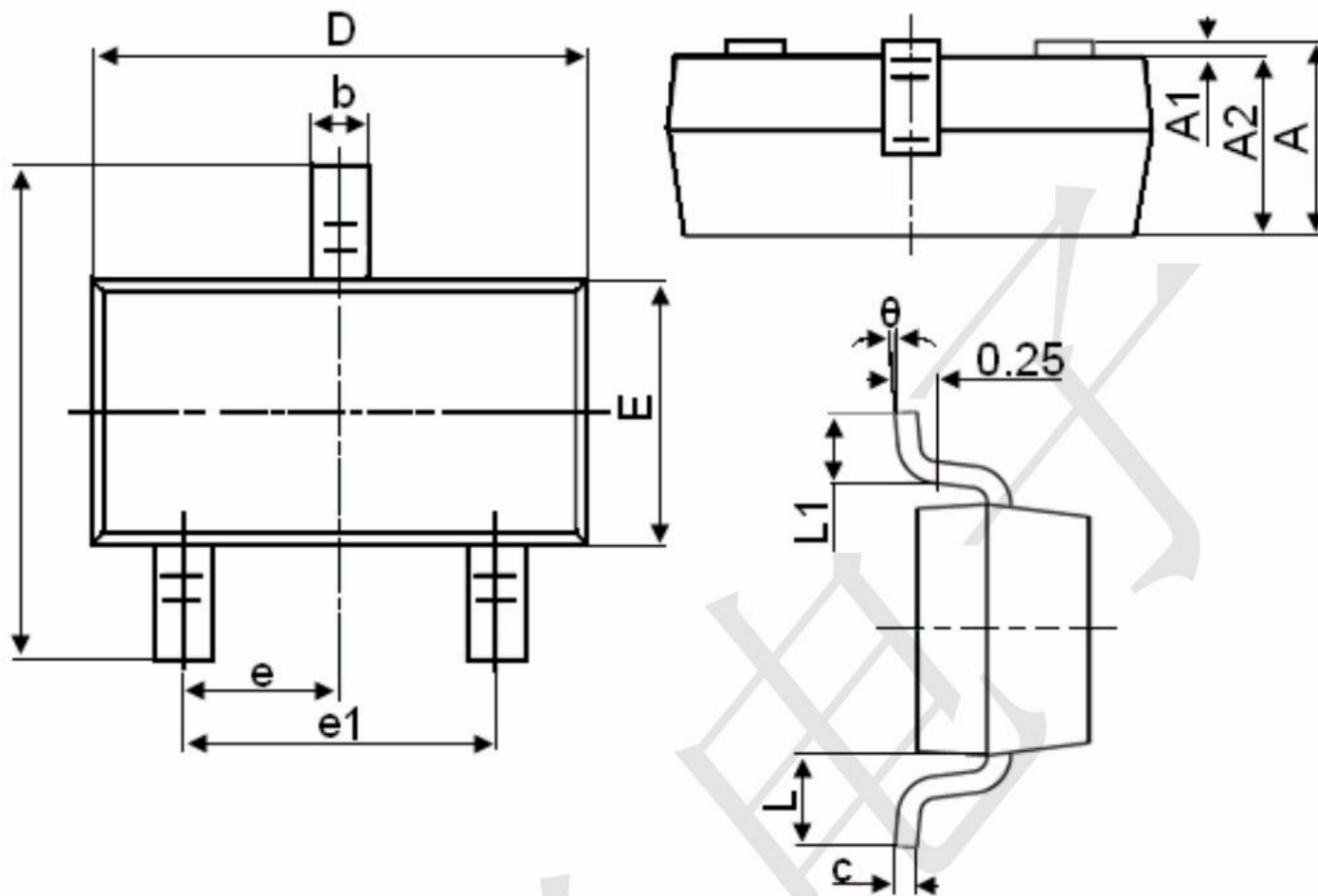

Figure 14 Normalized Maximum Transient Thermal Impedance

SOT-23 Package Information

(UNIT): mm



Symbol	Dimensions in Millimeters	
	MIN.	MAX.
A	0.900	1.150
A1	0.000	0.100
A2	0.900	1.050
b	0.300	0.500
c	0.080	0.150
D	2.800	3.000
E	1.200	1.400
E1	2.250	2.550
e	0.950TYP	
e1	1.800	2.000
L	0.550REF	
L1	0.300	0.500
θ	0°	8°