

# 规格书 Specification

品名  
Model name **HYT-0903 3v**

**PROPRIETARY**  
Huayu Electronic co.,Ltd.

**CONFIDENTIAL**  
Huayu Electronic co.,Ltd.

Version #	Spec V1.0
制作日期 Date	2019/4/01
准备 Prepared	Yi Shen Acoustic specialist,R&D Dept.
承认 Approved	Qian Wanjin Executive Manager,R&D Dept.



## 兴化市华宇电子有限公司

地址：江苏省兴化市陈堡工业区人民路 1 号

电话：13625199874 传真：0523-83723118

邮箱：[391245375@qq.com](mailto:391245375@qq.com) 网址：[www.js-huayu.com](http://www.js-huayu.com)

*Components Operating Div.  
Huayu Electronic co.,Ltd.*

1.适用范围：本规范适用于 HYT-0903 3v 蜂鸣器。

This specifications apply the HYT-0903 3v buzzer.

## 2.基本规格/General specification

项目/Item	规格/Spec	条件/Condition
1 额定电压 Rated voltage	3VDC	
2 工作电压 Operation voltage	2~5VDC	
3 声压 Sound Pressure Level=SPL	Min 85dB	测试环境：标准状态，标准驱动电路，额定电压
4 平均消费电流 Average consumption current	Max 40mA	测试距离：0.1m Standard State,Standard Drive Circuit.
5 振荡频率 Oscillation frequency	2900±300Hz	Rated voltage,Distance at 0.1m
6 响应时间 Response time	Max 50mS	
7 工作温度范围 Range of operation temperature	-20~+70°C	
8 保存温度范围 Range of preservation temperature	-30~+85°C	
9 端子强度 Terminal strength	10N	拉负荷方向的终端轴 Pull load on the direction of the terminal axis
10 外部尺寸 Externals size	Φ9x5.5	参阅附图 Refer to the attached drawing
11 重量 Mass	1.5g	

## 3. 电气和声学测试条件/Electrical And Acoustical Measuring Condition

### 驱动电路/Recommended Driving Circuit

Resonant frequency, 1/2 duty cycle. Square wave.

Signal amplitude should be large enough to saturate the transistor.

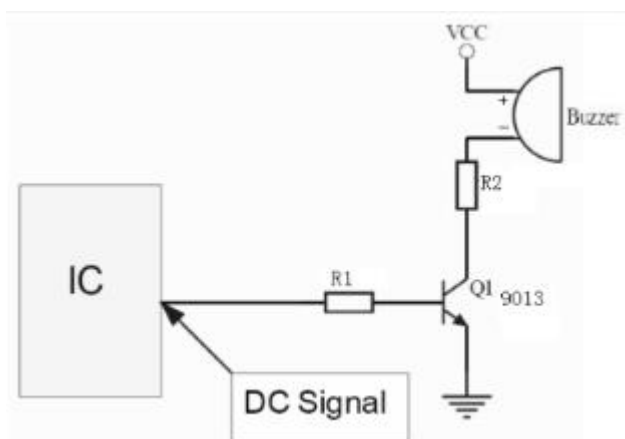

### 设置 Recommended Setting

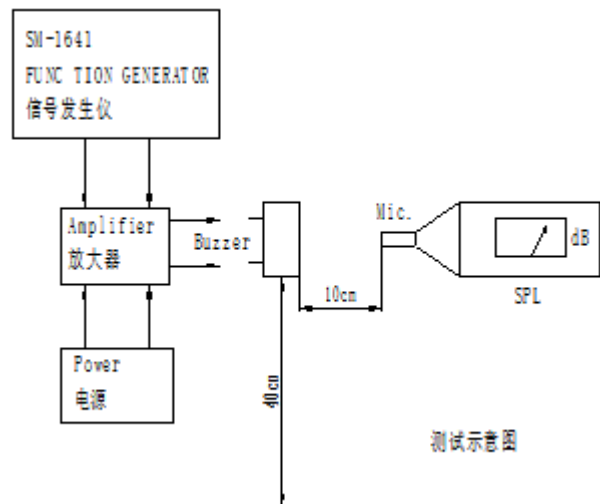

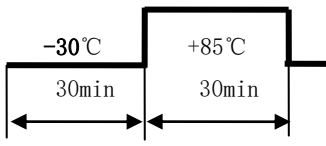
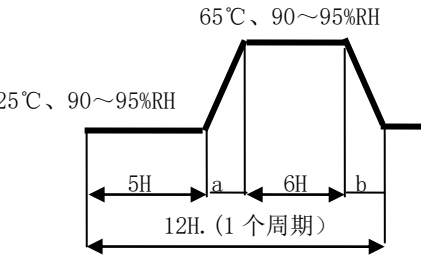
项目/Item		试验条件/Test condition	判断标准/Criteria	引用规格
1	高温保存试验 High temperature Preservation	+85℃环境下放置 96 小时 Exposure to +85℃ for 96 hrs.	经过测试,符合规格,没有任何不合格的外观和性能,除了是 75 分贝或以上 (2900±300 Hz) After the test the part shall meet specifications without any degradation in appearance and performance except SPL. SPL shall be 75 dB More. (at 2900±300 Hz)	GB/T 2423.2
2	低温保存试验 Low temperature preservation	-30℃环境下放置 96 小时 Exposure to -30℃ for 96 hrs.		GB/T 2423.1
3	耐温试验 Thermal Shock	 10 次周期 10 cycles		GB/T 2423.4
4	温湿度试验 Thermal, Humidity Shock	 10 cycles		
5	常温寿命试验 Ordinary Temp. Life	常温 (25℃±10℃) 电压 3VDC 连续测试 1000 小时 Driving the sounder at 3VDC for 1000hrs in the room temperature (25℃±10℃)		
6	高温寿命试验 High Temp. Life	高温 (+85℃) 电压 3VDC 连续测试 500 小时 Driving the sounder at 3VDC for 500hrs in the low temperature (+85℃)		
7	低温寿命试验 Low Temp. Life	低温 (-30℃) 电压 3VDC 连续测试 500 小时 Driving the sounder at 3VDC for 500hrs in the low temperature (-30℃)		
8	引脚拉力试验 Lead strength	10N 的拉力在引脚上拉 10±1 秒 Pull load on the direction of the terminal axis for 10±1 sec.		GB/T 2423.29
9	振动试验 Vibration	10~55~10Hz 正弦波测试 1 分钟, 振幅 1.52mm 最大 91m/S <sup>2</sup> X, Y, Z 三个方向每个 2 小时总计 6 小时 10~55~10Hz Sinewave, Sweep 1 min, Amplitude 1.52mm Max 91m/S <sup>2</sup> X, Y, Z 3Direction 2hrs each, Total 6hrs		GB/T 2423.10
10	自由掉落试验 Free drop	70cm 高自由掉落到厚 40mm 的木板上, 每个方向一次 Free drop, 70cm height, on wood board (t40mm) X, Y, Z 3Direction 1time each, total 3times.	排除弯曲的针 Exclude bending of Pin	GB/T 2423.8
11	波峰焊耐热试验 Solder heat resistance	250±5℃焊接温度。浸泡时间 3±0.2sec Soldering into solderbath: Solder Temp. 250±5℃ Soaking Time: 3±0.2sec	经过测试,符合规格,没有任何不合格的外观和性能 After the test the part shall meet specifications without any degradation in appearance and performance	GB/T 2423.28
12	耐洗性试验 Washability	溶剂: 去离子水, 溶剂温度: 55±5℃, 浸泡时间: 5±0.5 分钟 Solvent: deionized water, Solvent temp: 55±5℃ Soaking time: 5±0.5 minutes		
13	引脚可焊性试验 Solderability	40℃, 相对湿度 90~95%RH 放置 240 小时, 370±5℃焊接温度。 浸泡时间: 6±0.5sec。 Pretreatment: 40℃, 90~95%RH*240hrs Soldering into solderbath: Solder Temp. 370±5℃ Soaking Time: 6±0.5sec	引脚 95% 必须覆盖着焊料 95% surface of lead pins must be covered with fresh solder and no soldering holes Should be found	GB/T 2423.28

5. 尺寸图/Dimension

(UNT: mm)

Tolerance:  $\pm 0.5\text{mm}$  Except Specified

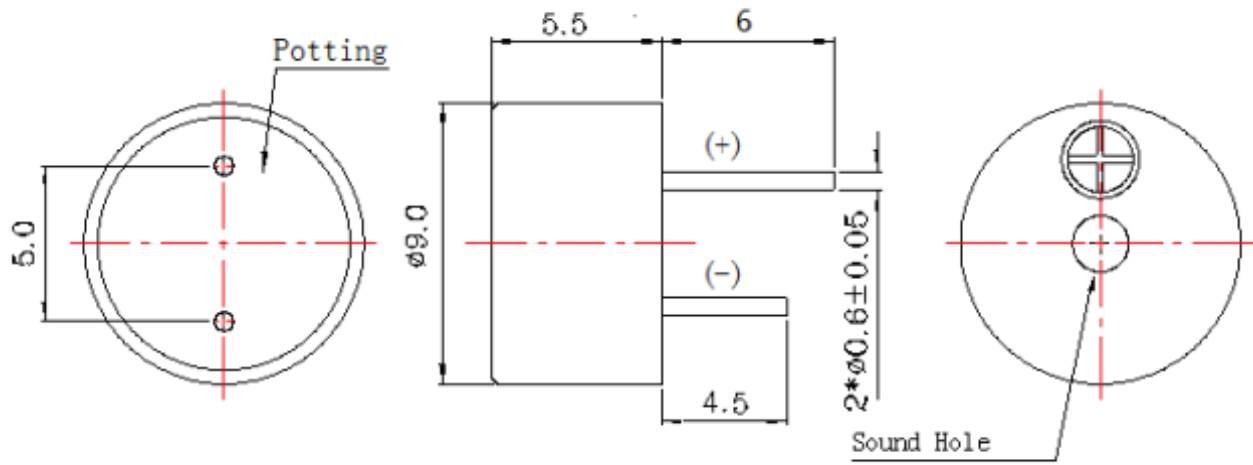

6. 频率图/Frequency Curve

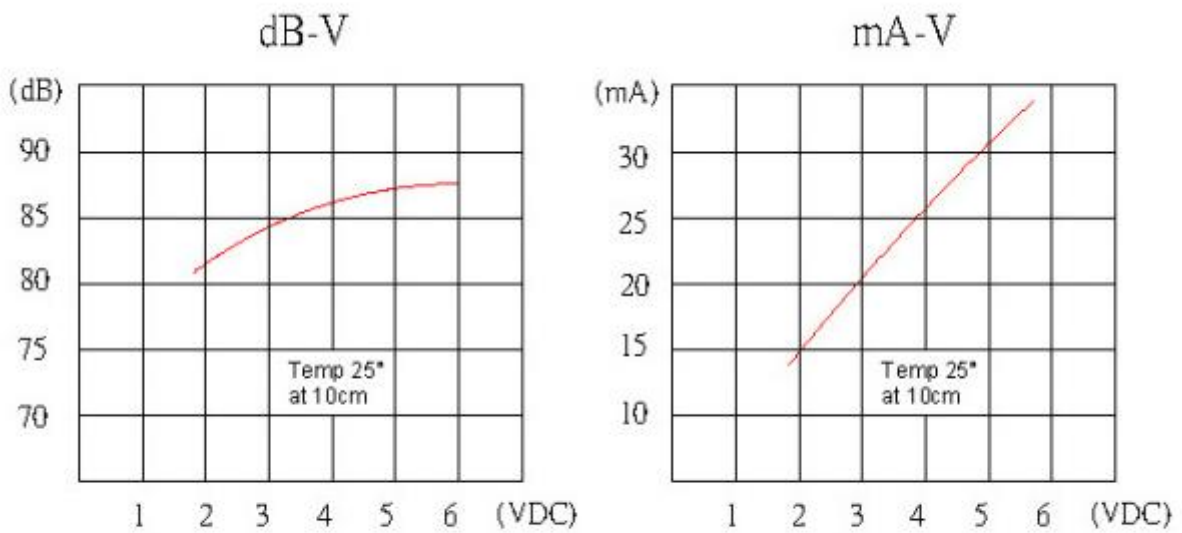

3Vo-p 50% duty Square wave, 10cm

## 7. 包装图/Packing Method

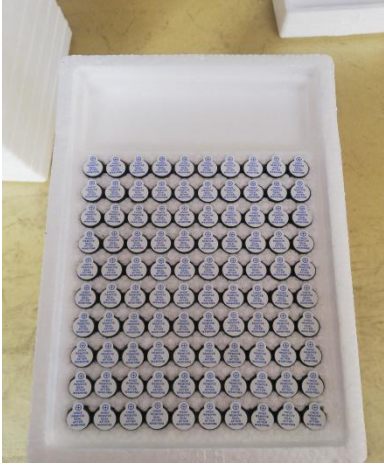

**QTY:100PCS**



**QTY:1000PCS**



**QTY:5000PCS**