

## Power-Over-Ethernet Module

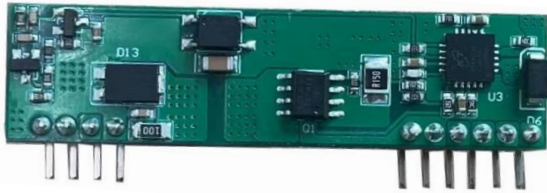

### 1.Product characteristics

- Compliance with IEEE802.3at standard.
- 42V~57V wide operating voltage range.
- Maximum output power up to 24W; Rated output: 12V/2A.
- The output ripple is less than 100 mV.
- Conversion efficiency can be as high as 84% (input: 48V output)12V@2A).
- Withovercurrent, short circuit, under voltage, surge andother excellent reliability and circuit protection.
- PCBA standard size: 56mm\*14.3mm\*16mm
- Input/Output: isolate 1500Vdc.
- High reliability: The design meets the 5 million hour average failure interval.

### 2.Scope of application

- Video and VoIP Phone
- RFID Reader
- Multiband Access Point
- Surveillance camera

### 3.describe

- The module is designed to extract power from traditional class 5 Ethernet cable twisted pair, and meets IEEE 802.3at power Ethernet (POE) standard.
- Based on the IEEE 802.3at standard, this paper establishes information connection about the connection status, device type, power consumption level of the receiving device PD, and then applies 25W power supply to port compatible devices based on PSE to power the PD through ethernet.
- This module DC/DC converter works in a wide input voltage range and low ripple low noise output.The DC/DC converter also has built-in output overload, output short circuit and overtemperature protection, and provides a 1500Vdc (input/output) electrical isolation.

### 4. Mechanical dimensions

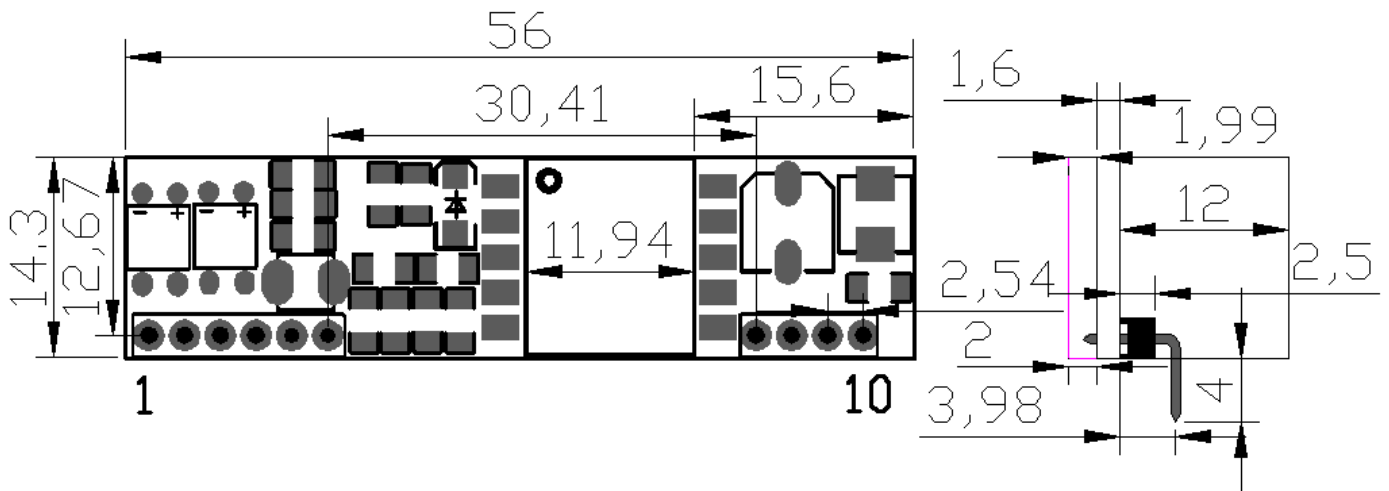

Company (mm)

All the above dimensional errors: ( $\pm 0.3$ )

#### 4.1 pin definition

Pin	Name	describe
1	VA1	This input pin is used in conjunction with VA2 and connects to the centre tap of the transformer connected to pins 1& 2 of the RJ45 connector (TX) - it is not polarity sensitive.
2	VA2	This input pin is used in conjunction with VA1 and connects to the centre tap of the transformer connected to pins 3& 6 of the RJ45 connector (RX) - it is not polarity sensitive.
3	VB1	This input pin is used in conjunction with VB2 and connects to pin 4 & 5 of the RJ45 connector - it is not polarity sensitive.
4	VB2	This input pin is used in conjunction with VB1 and connects to pin 7 & 8 of the RJ45 connector - it is not polarity sensitive.
5,6	NC	For internal connection use.
7	Vout-	is the negative output of the PD.
8	Vout+	is the positive output of the PD.
9	NC	Reserved fixed pin.
10	NC	Reserved fixed pin.

## 5. Electrical characteristics

### 5.1 Absolute maximum rating parameter

No	parameter	Symbol	MIN	MAX	Units
1	DC Voltage	VCC	42	57	V
2	DC Voltage Surge 1ms	VSURGE	-0.6	80	V
3	ambient temperature	TS	-40	80	°C

\*Exceeding the above rating may cause permanent damage to the product. Functional operations under these conditions are not recommended.

### 5.2 Recommended working conditions

No	parameter	Symbol	MIN	TYP	MAX	Units
1	input voltage	VIN	42	48	57	V
2	Low Voltage Lock	VLOCK	37	-	-	V
3	working temperature	TOP	-40	25	80	°C

\*Applicable only to WC-PD26C120A maximum operating temperature.

### 5.3 DC Characteristic

No	parameter	Symbol	MIN	TYP	MAX	Units	Test Opinions
1	Standard Output Voltage	VDC	11.75	12.0	12.2	V	VIN=48V
2	Output Current (VIN=39V)	PWR	-	2	-	A	Wide voltage input 39-57V
3	Power adjustment rate	VLINE	-	0.1	-	%	@50% Load
4	Load Adjustment Rate	VLOAD	-	1	-	%	@VIN=48V
5	Ripple Output Noise	VRN	-	100	150	mVp-p	@Maximum Load
6	Minimum Load	RLOAD	10	-	-	mA	
7	Short circuit duration	TSC	-	-	∞	sec	
8	Efficiency (load 80%)	EFF	80	84	-	%	
9	Isolation Voltage (I/O)	VISO	-	-	1500	VPK	
10	temperature coefficient	Tc	-	0.02		%	Per °C
11	transient response	Tr	-	100	250	ms	Vin=48V Vout=max

1: Typical number is 25 C, nominal voltage is 48V, for auxiliary design only.

2: Output ripple and noise can be reduced by an external filter, see the application instructions.

3: If operated under the specified minimum load, the module emits audible noise and may cause PSE malfunction.

## 6 Functional Description

### 6.1 input

The input terminal of WC-PD26C120A is not preset with "bridge reactor", so it is necessary to pay attention to the polarity of power supply core.

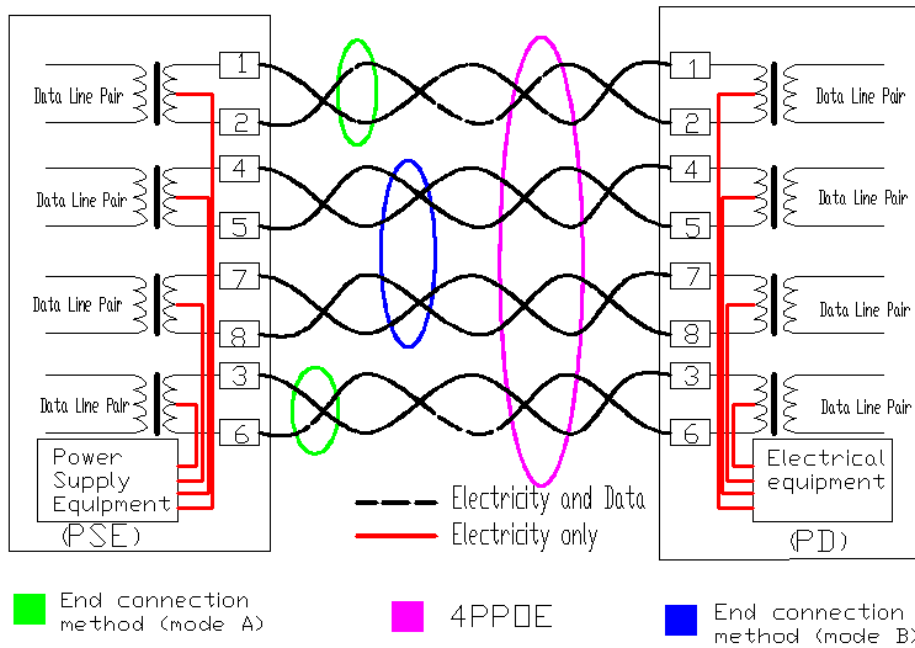

### 6.2 PD Signature

When the module is connected to the cable, it will automatically provide the Power Device (PD) signature to the PSE when needed. The PSE recognizes that the PD is connected to that line and provides power

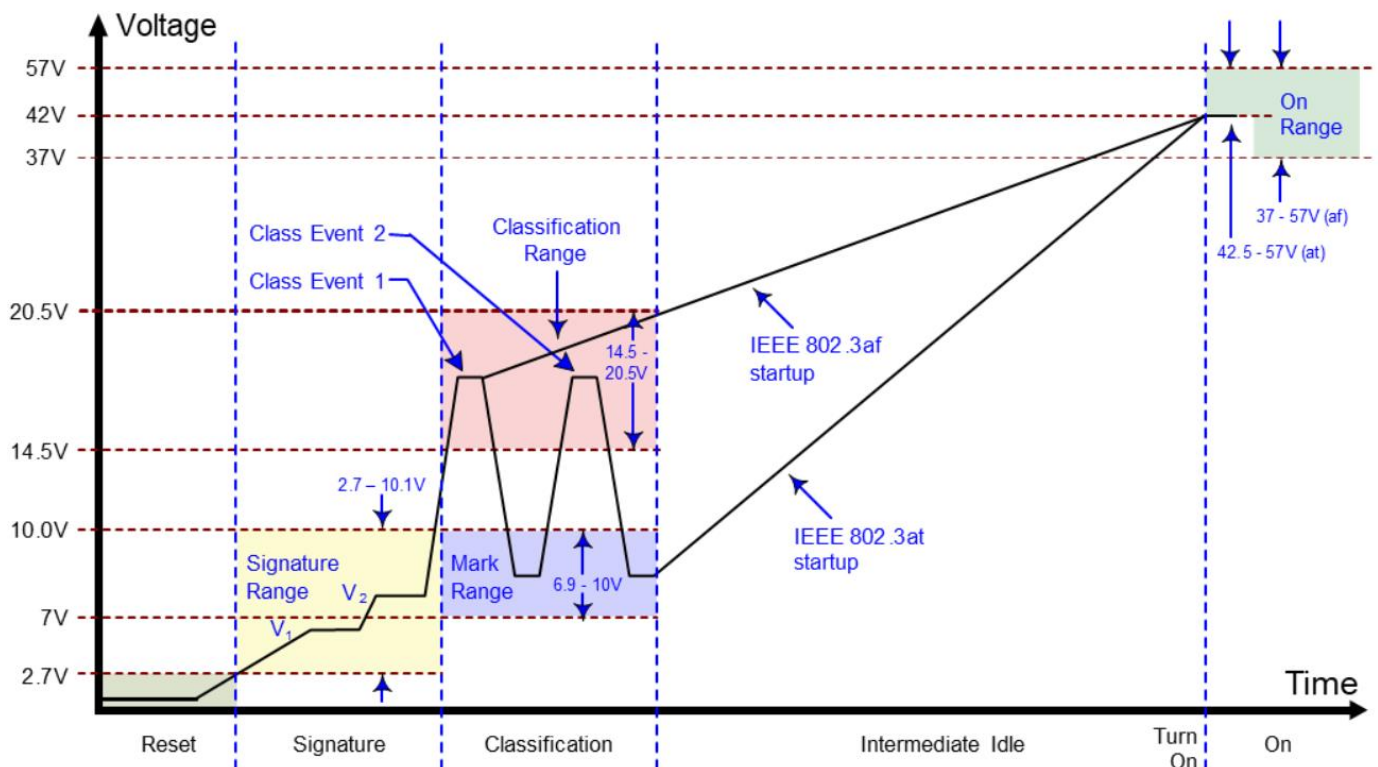

### 6.3 Power Classification

WC-PD26C120A uses IEEE802.3at standard and runs with Class 4 (24W) power rating by default.

Define criteria	Cable requirements	Grading parameters	Power Supply Characteristics
IEEE802.3at (PoE Plus)	CAT5 cable or CAT6 cable	Maximum power required for Class4 devices is 13W~25.5W	The DC voltage ranges from 42V to 57V, with a typical value of 48V.  Typical operating current is 10~600mA; typical output power: 30W;  Class4 rating supported by electrical equipment
IEEE802.3af (PoE)	CAT5 cable	Maximum power required for Class0 devices is 0~12.95W	The DC voltage ranges from 38 to 57V, with a typical value of 48V.  Typical operating current is 10~350mA; typical output power: 15.4W;  The overload detection current is 350~500mA.  Provide 4 Class Power Requests for PD Devices ranging from 3.84 to 12.95W
		The maximum power required for Class1 devices is 0~3.84W	
		The maximum power required for Class2 devices is 3.85W~6.49W	
		The maximum power required for Class3 devices is 6.5W~12.95W	

### 7. Typical schematic diagram

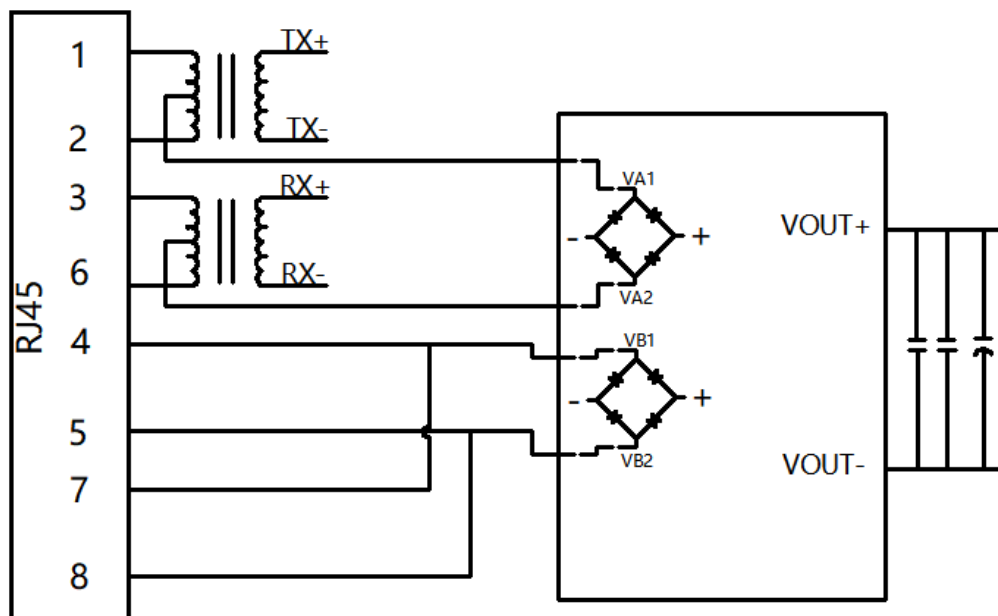

## 8. PoE Product naming rules

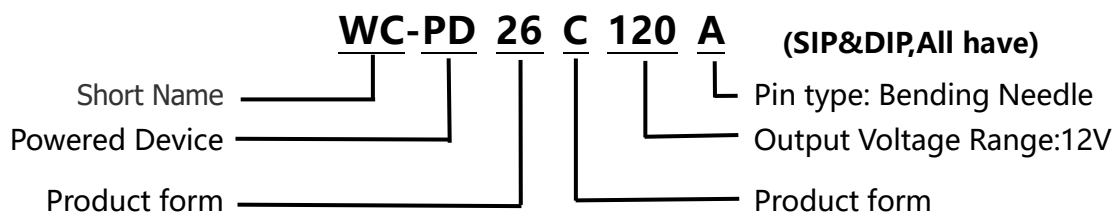

## 9. Typical applications

This module is used in PSE network cable to convert electric energy to DC-DC to the required voltage of equipment without affecting data signal transmission. It conforms to IEEE 802.3at standard and is used by all equipment terminals

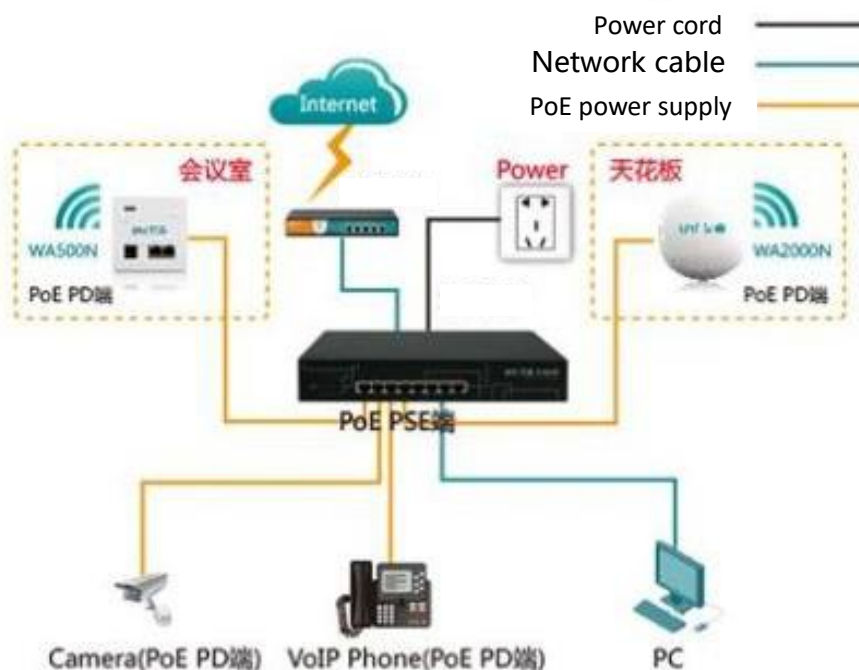

# 10. Test waveform diagram

Typical features: Vout=12V

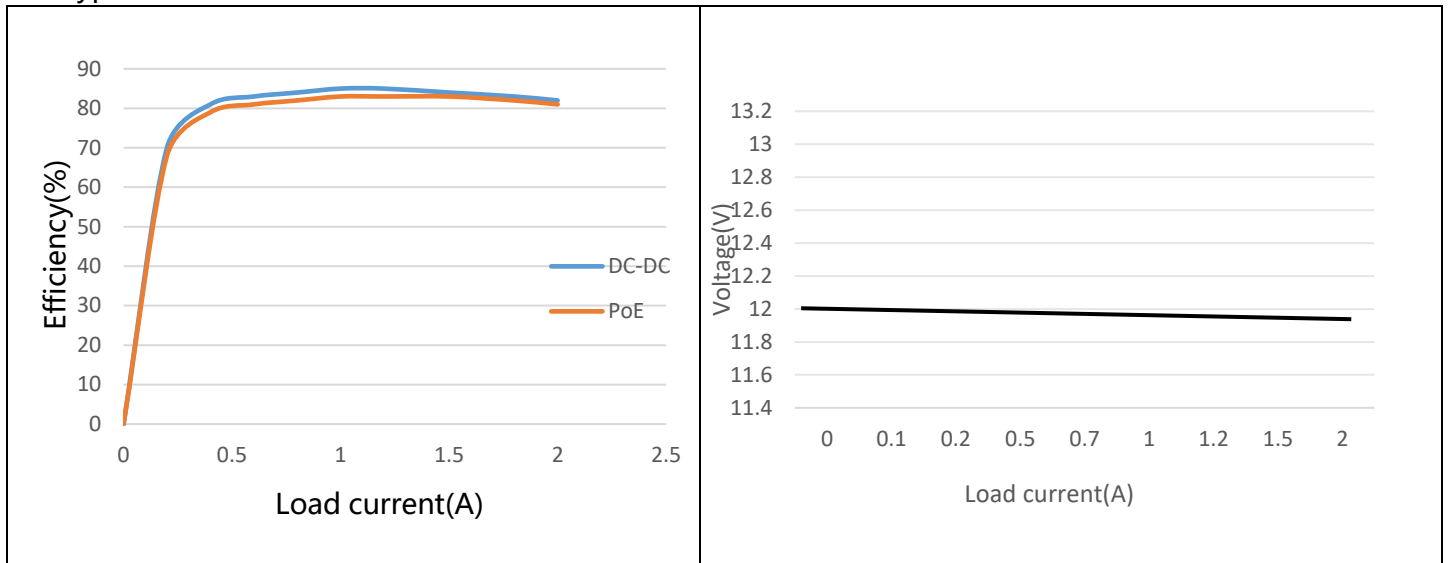

Efficiency (Vout = 12 V)

Output voltage (input 48V)

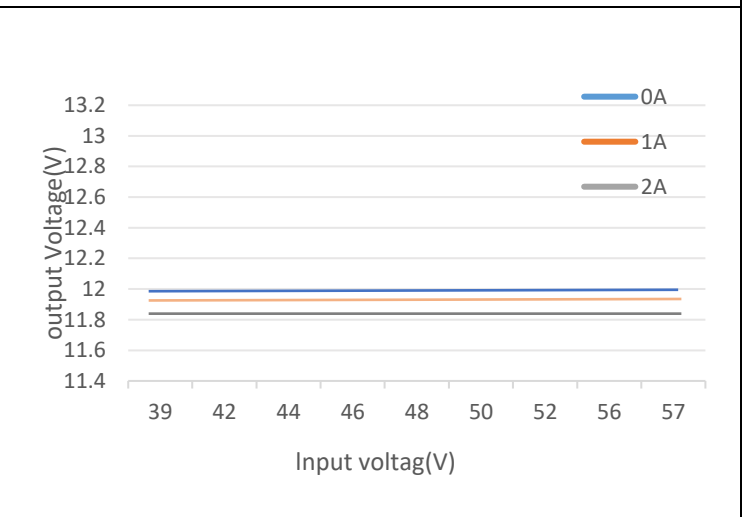
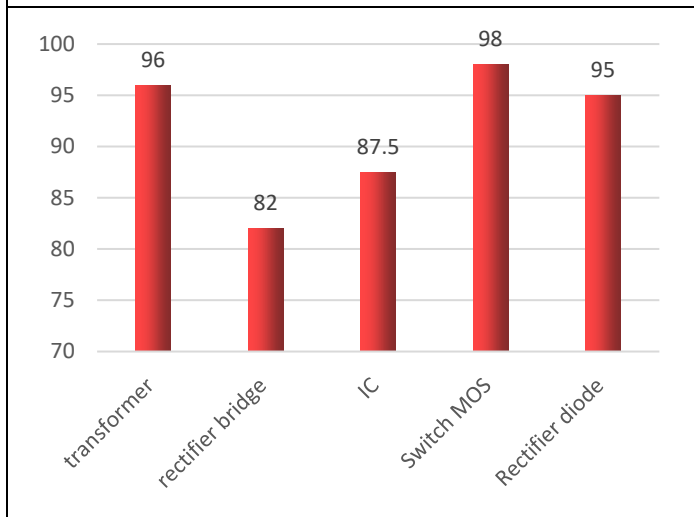

Maximum temperature of components  
 Conditions (ambient temperature: 27 °C;  
 output power: 12V / 2A; frequency: 3H)

Input voltage & output voltage

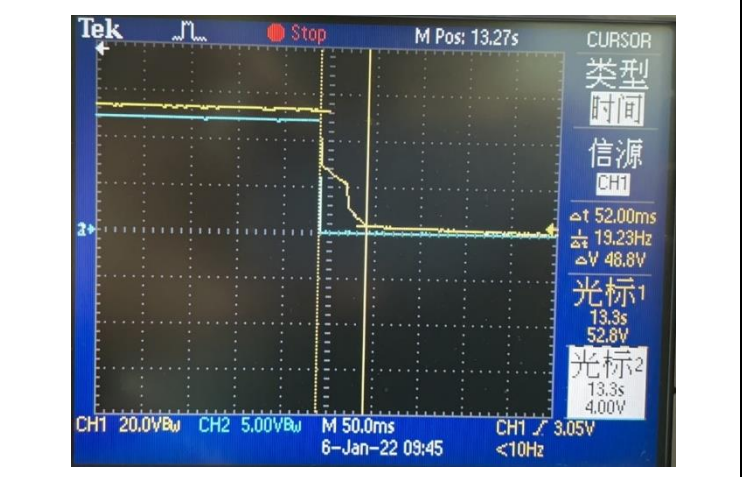
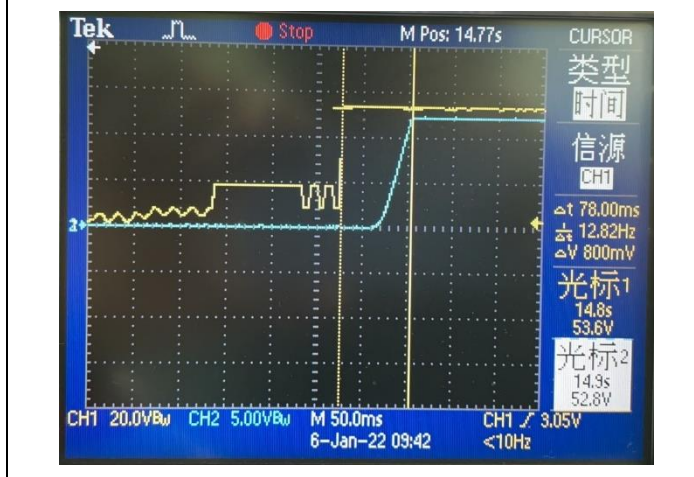

Power on

Power down

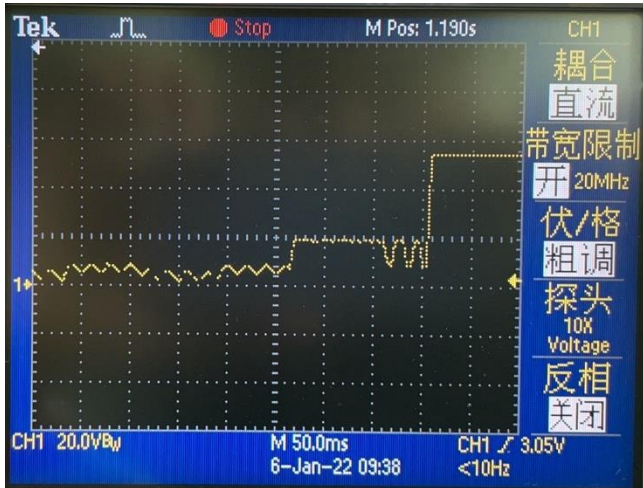

Power Supply Protocol

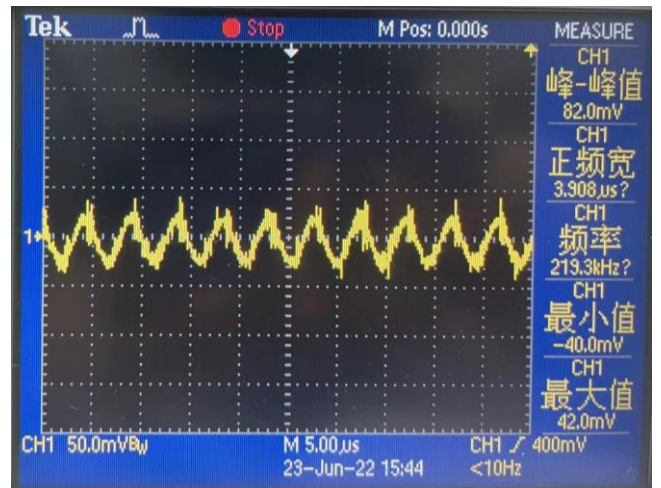

Output ripple  
(12V / 2A&470uF)

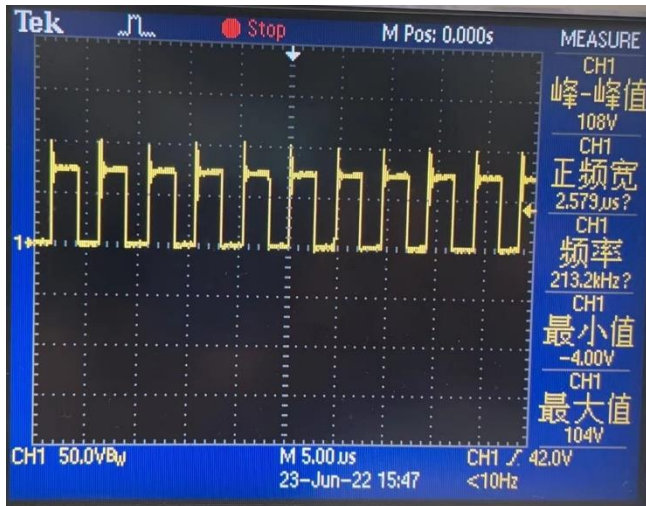

Transformer Switch Waveform

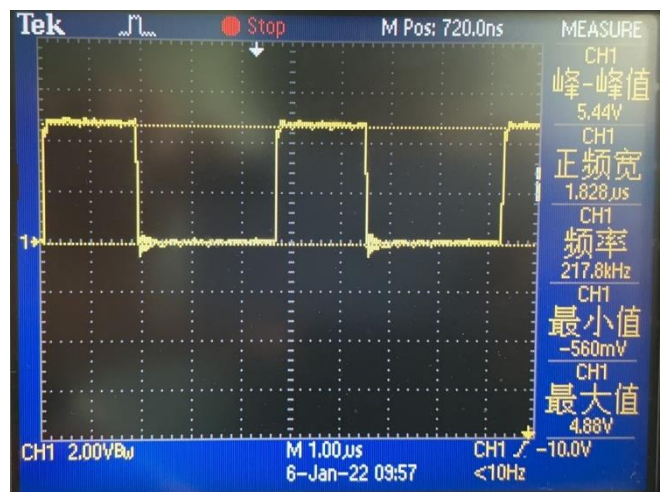

MOS switch waveform

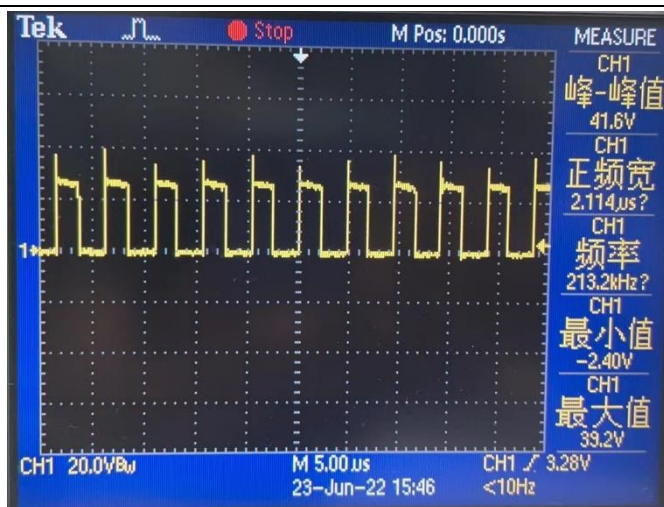

Output diode waveform

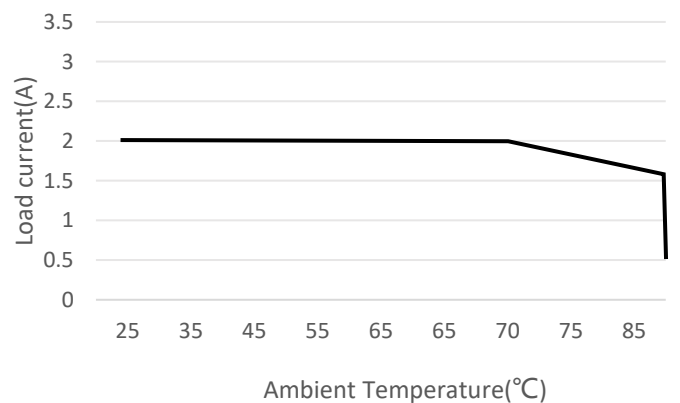

Derating