

PCB Layout

Specifications:

规格:

- Voltage rating: 250V AC/DC
- 额定电压: 250V AC/DC
- Current rating: 3A AC/DC
- 额定电流: 3A AC/DC
- Withstanding voltage: 1000V AC/minute
- 耐受电压: 1000V AC/分钟
- Temperature range: -25°C +85°C
- 温度范围: -25°C +85°C
- Insulation resistance: 1000MΩ min
- 绝缘电阻: 1000MΩ Min
- Contact resistance: 20mΩ Max
- 接触电阻: 20mΩ Max

X2501 W V - XX - N0 SN  
 ① ② ③ ④ ⑤ ⑥

1. Series No
2. Category: W-Wafer
3. Welding Board Angle: V-Straight 180°
4. Row No. Pin No: XX-02~16 Pin
5. Material: N0-PA66 UL94V-0 (Natural)
6. Plating: SN-Tin Plated  
V01-Gold Flash

Poles	Dimensions(mm)		Poles	Dimensions(mm)	
	A	B		A	B
02	2.50	5.00	10	22.50	25.00
03	5.00	7.50	11	25.00	27.50
04	7.50	10.00	12	27.50	30.00
05	10.00	12.50	13	30.00	32.50
06	12.50	15.00	14	32.50	35.00
07	15.00	17.50	15	35.00	37.50
08	17.50	20.00	16	37.50	40.00
09	20.00	22.50			

X2501WV-XX-N0SN	PA66	Brass	X2501H
PART NO	Material	Material(Pin)	Suitable XKB Housing

DSND		SCALE: N/A	MODEL TYPE: 2.5mm Crimp Style Connector
DWN		VIEW:	PART NO.: X2501WV-XX-N0SN
CHKD		UNIT: mm/in	DWG NO.: X-X2501WV-XX-N0SN
APPD		SIZE: A4	



XKB INDUSTRIAL PRECISION CO., LIMITED

WEIGHT	SHEET	REVISION
	1/1	A0

广东星坤科技股份有限公司

Δ 姓	日期
Δ 数	
Δ X	

文件工程章

MARK	DESCRIPTION	DATE	REVISED	APPROVED	UNSPECIFIED TOLERANCES
					ANGLAR ±5°
					L ≤ 4 ±0.2
					4 < L ≤ 16 ±0.3
					16 < L ≤ 63 ±0.4
					L > 63 ±0.5

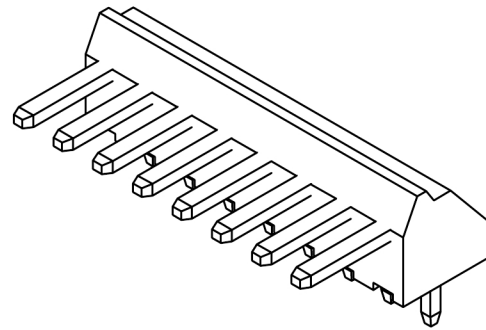
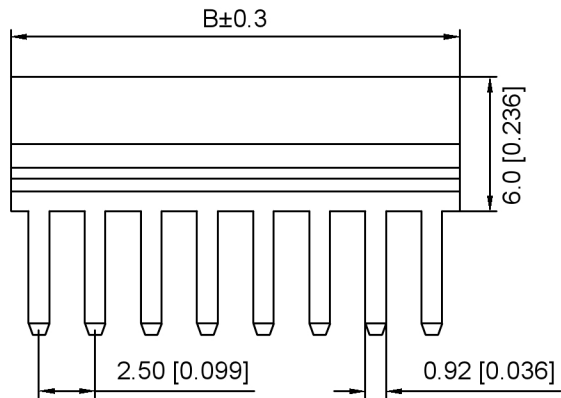

Specifications:  
 规格:  
 Voltage rating:250V AC/DC  
 额定电压: 250V AC/DC  
 Current rating:3A AC/DC  
 额定电流: 3A AC/DC  
 Withstanding voltage:1000V AC/minute  
 耐受电压: 1000V AC/分钟  
 Temperature range:-25°C~+85°C  
 温度范围: -25°C~+85°C  
 Insulation resistance:1000MΩ min  
 绝缘电阻: 1000MΩ Min  
 Contact resistance:20mΩ Max  
 接触电阻: 20mΩ Max

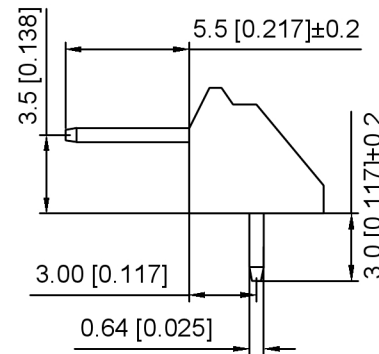
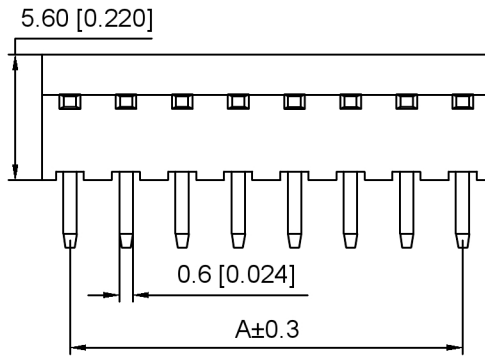

X2501 W R - XX - N0 SN  
 ① ② ③ ④ ⑤ ⑥

- 1.Series No
- 2.Category:W-Wafer
- 3.Welding Board Angle:R-Straight 90°
- 4.Row No.Pin No:XX-02~16 Pin
- 5.Material:N0-PA66 UL94V-0 (Natural)
- 6.Plating:SN-Tin Plated  
V01-Gold Flash

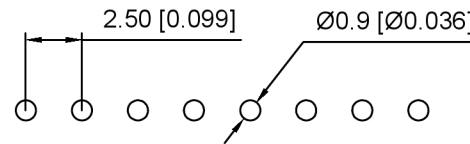
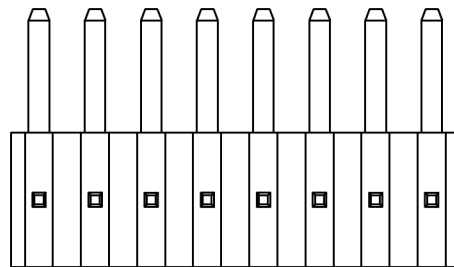

PCB Layout

Poles	Dimensions(mm)		Poles	Dimensions(mm)	
	A	B		A	B
02	2.50	5.00	10	22.50	25.00
03	5.00	7.50	11	25.00	27.50
04	7.50	10.00	12	27.50	30.00
05	10.00	12.50	13	30.00	32.50
06	12.50	15.00	14	32.50	35.00
07	15.00	17.50	15	35.00	37.50
08	17.50	20.00	16	37.50	40.00
09	20.00	22.50			

X2501WR-XX-N0SN	PA66	Brass	X2501H
PART NO	Material	Material(Pin)	Suitable XKB Housing

DSND		SCALE: N/A	MODEL TYPE: 2.5mm Crimp Style Connector
DWN		VIEW:	PART NO.: X2501WR-XX-N0SN
CHKD		UNIT: mm/in	DWG NO.: X-X2501WR-XX-N0SN
APPD		SIZE: A4	WEIGHT SHEET REVISION
			1/1 A0



XKB INDUSTRIAL PRECISION CO.,LIMITED

ANGULAR	±5°
L ≤ 4	±0.2
4 < L ≤ 16	±0.3
16 < L ≤ 63	±0.4
L > 63	±0.5
UNSPECIFIED TOLERANCES	

广东星坤科技股份有限公司

DATE	日期
REVISIONS	文件工程章

MARK	DESCRIPTION	DATE	REVISED	APPROVED
------	-------------	------	---------	----------

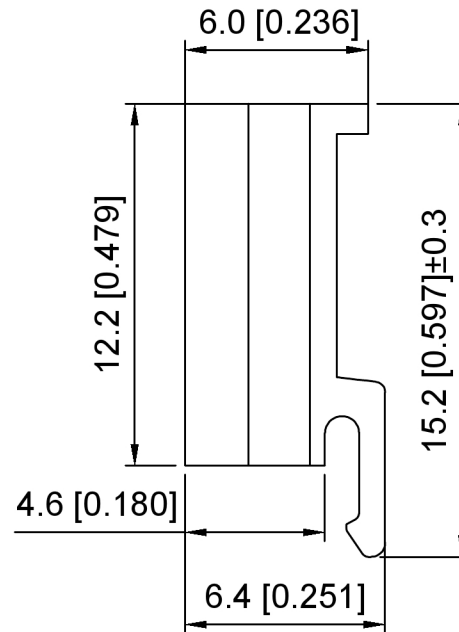
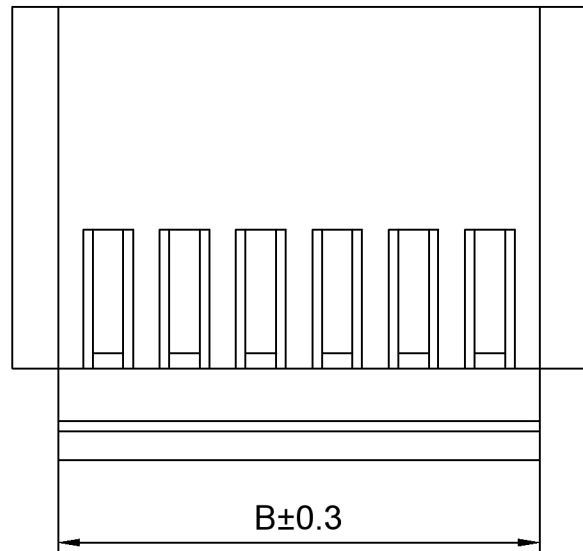
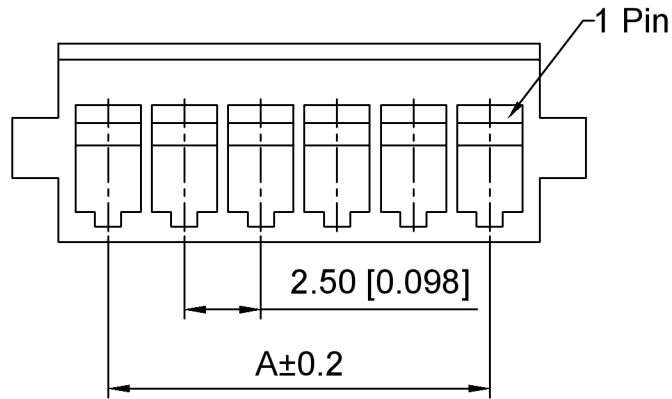

Specifications:

规格:

Voltage rating:250V AC/DC

额定电压: 250V AC/DC

Current rating:3A AC/DC

额定电流: 3A AC/DC

Withstanding voltage:1500V AC/minute

耐受电压: 1500V AC/分钟

Temperature range:-25°C~+85°C

温度范围: -25°C~+85°C

Insulation resistance:500MΩ min

绝缘电阻: 500MΩ Min

Contact resistance:15mΩ Max

接触电阻: 15mΩ Max

X2501 H - XX - N0 X  
 ① ② ③ ④ ⑤

1.Series No

2.Category:H-Housing

3.Row No.Pin No:XX-02~25 Pin

4.Material:N0-PA66 UL94V-0

5.Color: BK-Black ; BN-Brown ; BL-Blue  
 R-Red ; G-Green ; W-White ; Y-Yellow

Poles	Dimensions(mm)		Poles	Dimensions(mm)	
	A	B		A	B
02	2.50	5.90	14	32.50	35.90
03	5.00	8.40	15	35.00	38.40
04	7.50	10.90	16	37.50	40.90
05	10.00	13.40	17	40.00	43.40
06	12.50	15.90	18	42.50	45.90
07	15.00	18.40	19	45.00	48.40
08	17.50	20.90	20	47.50	50.90
09	20.00	23.40	21	50.00	53.40
10	22.50	25.90	22	52.50	55.90
11	25.00	28.40	23	55.00	58.40
12	27.50	30.90	24	57.50	60.90
13	30.00	33.40	25	60.00	63.40

X2501H-XX-N0X	PA66	X2501W	X2501T
PART NO	Material	Suitable XKB Wafer	Suitable XKB Terminal

DSND	SCALE: N/A	MODEL TYPE: 2.5mm Crimp Style Connector
DWN	VIEW:	PART NO.: X2501H-XX-N0X
CHKD	UNIT: mm/in	DWG NO.: X-X2501H-XX-N0X
APPD	SIZE: A4	



XKB INDUSTRIAL PRECISION CO., LIMITED

WEIGHT	SHEET	REVISION
	1/1	A0

广东星坤科技股份有限公司

Δ姓	日期
Δ数	
ΔX	

文件工程章

MARK	DESCRIPTION	DATE	REVISED	APPROVED	UNSPECIFIED TOLERANCES
					ANGULAR ±5°
					L ≤ 4 ±0.2
					4 < L ≤ 16 ±0.3
					16 < L ≤ 63 ±0.4
					L > 63 ±0.5

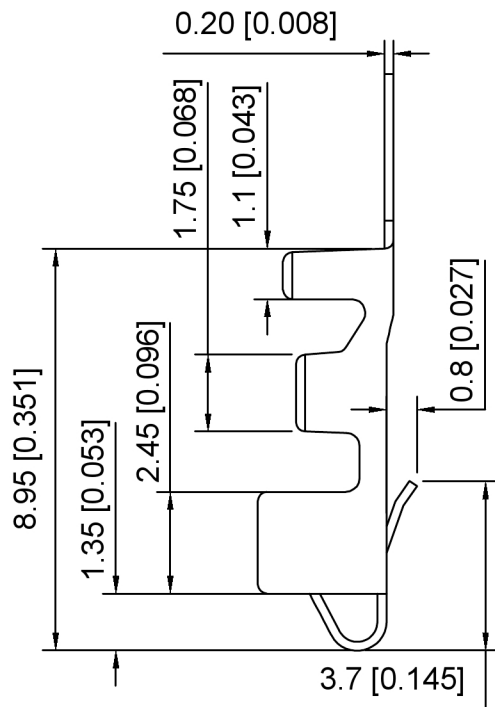
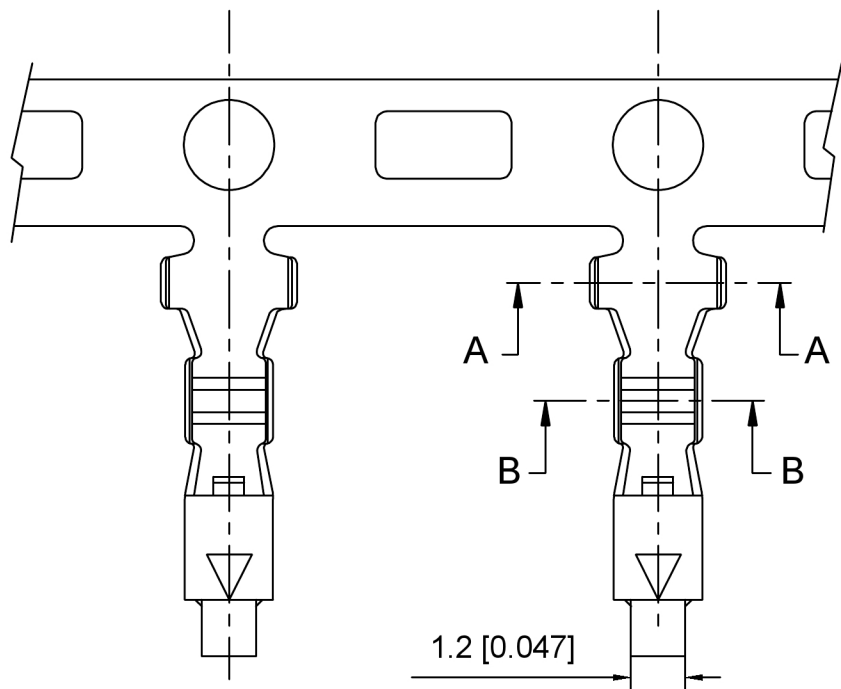

Specifications:  
 规格:  
 Voltage rating:250V AC/DC  
 额定电压: 250V AC/DC  
 Current rating:3A AC/DC  
 额定电流: 3A AC/DC  
 Withstanding voltage:1500V AC/minute  
 耐受电压: 1500V AC/分钟  
 Temperature range:-25°C~+85°C  
 温度范围: -25°C~+85°C  
 Insulation resistance:500MΩ min  
 绝缘电阻: 500MΩ Min  
 Contact resistance:10mΩ Max  
 接触电阻: 10mΩ Max

X2501 T - P SN  
 ① ② ③ ④

- 1. Series No
- 2. Category:T-Terminal
- 3. Material:P-Phosphor Bronze
- 4. Plating:SN-Tin Plating  
V01-Gold Flash

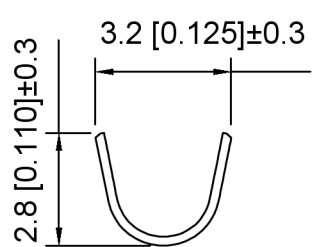

SEC:A-A

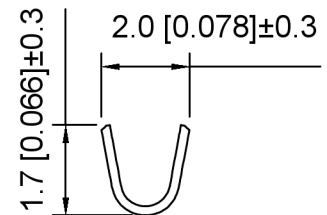
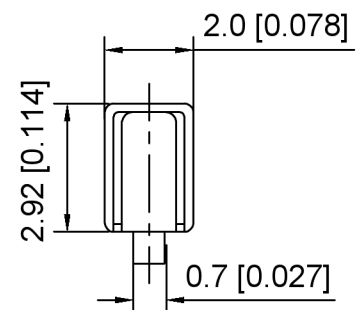

SEC:B-B

X2501T-PSN	Phosphor Bronze	AWG#22~28 O.D.1.8mm	X2501H
PART NO	Material	Wire Range	Suitable XKB Housing

DSND	SCALE: N/A	MODEL TYPE: 2.5mm Crimp Style Connector
DWN	VIEW:	PART NO.: X2501T-PSN
CHKD	UNIT: mm/in	DWG NO.: X-X2501T-PSN
APPD	SIZE: A4	

广东星坤科技股份有限公司

Δ#	日期
Δx	
Δx	
Δx	

文件工程章

MARK	DESCRIPTION	DATE	REVISED	APPROVED	UNSPECIFIED TOLERANCES
	REVISIONS				



XKB INDUSTRIAL PRECISION CO., LIMITED

WEIGHT	SHEET	REVISION
	1/1	A0