

RoHS Compliant

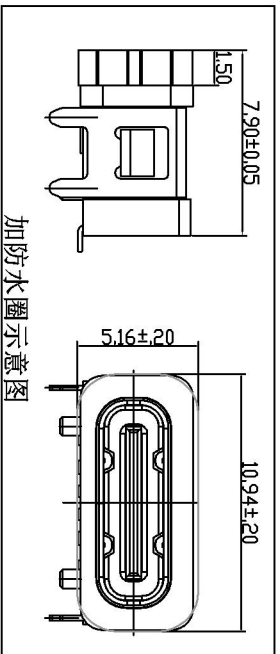
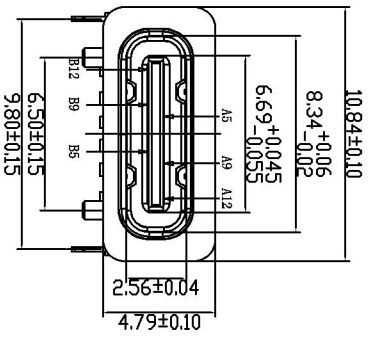
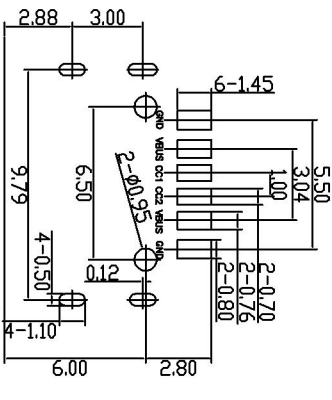
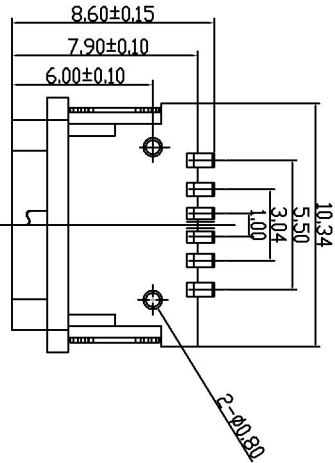
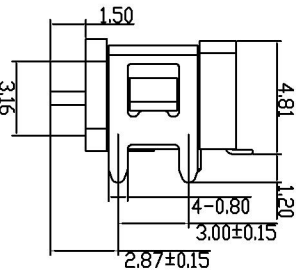
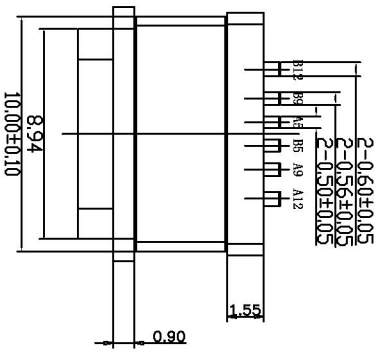
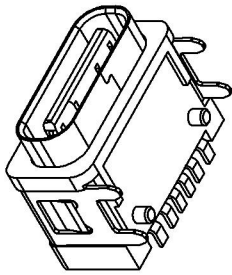
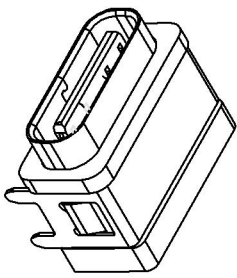
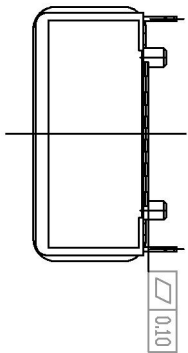

TABLE:

NO	PART	QTY	Material
1	SHELL	1	STAINLESS STEEL, NI PLATED
2	CONTACT	6	COPPER STEEL, TIN/AU/NI PLATED
3	MID PLATE	1	STAINLESS STEEL, NO PLATING
4	IMD HOUSING	1	HIGH TEMPERATURE RESISTANT PLASTIC BLACK UL94 V-0
5	2MD HOUSING	1	HIGH TEMPERATURE RESISTANT PLASTIC BLACK UL94 V-0
6	SHIELDING PLATE	1	STAINLESS STEEL, NI PLATED

RECOMMEND PCB LAYOUT (COMPONENT SIDE)
TOLERANCE FOR PCB LAYOUT IS ±0.05

USB TYPE-C PIN ASSIGNMENTS

PIN NUMBER	A1	A2	A3	A4	A5	A6	A7	A8	A9	A10	A11	A12
SIGNAL NAME					CC1				VARS			GND
PIN NUMBER	B12	B11	B10	B9	B8	B7	B6	B5	B4	B3	B2	B1
SIGNAL NAME	GND			VARS				CC2				GND

深圳市连欣科技有限公司

品名 (ITEM NO) TYPE-C 8PIN板上四脚插板SMT防水母座 后柱 防水等级IPX7级

料号 (PART NO) XUBF-0331-0679

型号 (MODEL NO) N/A

图号 (DWG NO) 单位 (UNIT) : MM

版本 (REV) A/0 比例 (SCALE) 1:1

日期 (DATE) 2015.06.09

设计 (DESIGN)

审核 (CHECKED)

核准 (APPROVED)

公差
TOLERANCE UNRESTRICTED
X.X
X.XX
X.XXX
±0.30
±0.20
±0.10
±5°
±2°

- NOTES:
SPECIFICATION:
1. CURRENT RATING: 3.0A MAX
2. VOLTAGE: 100 VAC
3. TEMPERATURE RANGE: -30°C~+85°C
4. CONTACT RESISTANCE: 40 MILLION HM MAX
5. INSULATION RESISTANCE: 100 MEG OHMS MIN
6. INSERTION FORCE: 5N~20N
7. UNMATING FORCE: 8N~20N
8. DURABILITY: 10000 CYCLES
9. WATER PROOFNESS: THIS PRODUCT IS BASED ON IPX8.

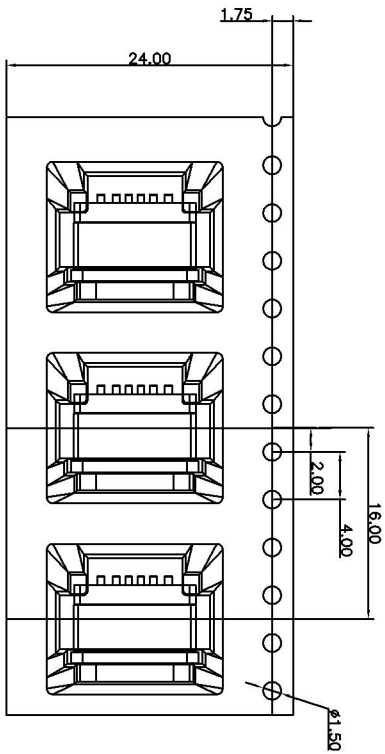

① 产品入载带示意图

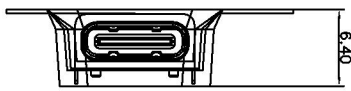

② 卷盘贴标签示意图

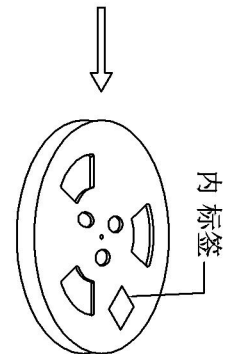

③ 7盘产品叠层示意图

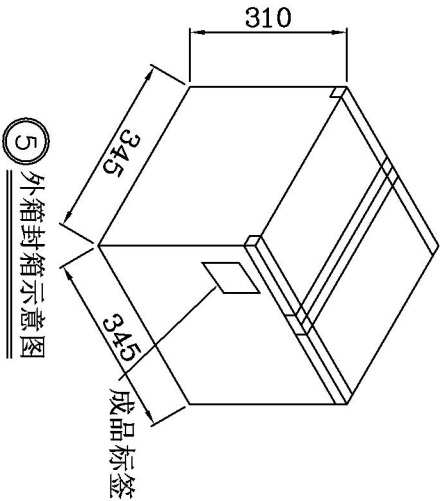

④ 外箱封箱示意图

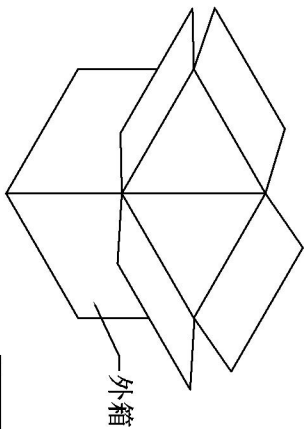

⑤ 产品入外箱示意图

CONNECTOR (PCS)	REEL	CARTON
	700	4900

包装说明:

1. 将检验好的成品;对插口朝前放入载带;每卷装700PCS产品;具体如图一所示
2. 将包装好的产品;每盘必需贴上内标签;具体如图二所示
3. 将贴好内标签的产品每7盘叠;具体如图三所示
5. 装好后并封好纸箱及贴好相关标签;具体如图五所示;
(产品包装的标签,如客户有要求,请按客户要求包装出货)
6. 载带前面留16PCS空格,后面留16PCS空格
7. COVER与CARRY剥离力:50-125g,速度:300mm/分钟左右,
剥离角度:165°-180°

深圳市连欣科技有限公司

品名 (ITEM NO)	包装规范
料号 (PART NO)	XUBF-0331-0679
型号 (MODEL NO)	N/A

图号 (DWG NO)	版本 (REV)	日期 (DATE)	设计 (DESIGN)	审核 (CHECKED)	核准 (APPROVED)
	A/0	2015.06.09		~	
单位 (UNIT): MM	比例 (SCALE) 1:1	公差 TOLERANCE UNSPECIFIED			
		±0.30 ±0.20 ±0.10 ±5° ±2°			