



LUCKI CM ELECTRONICS Co.,Ltd



承认书

APPROVAL SHEET

客户代码 Customer : _____

产品名称 Part Number : 石英晶体谐振器

LK 料号 LK Part No. : L214S400C11L

产品型号 Holder : SMD 2016

标称频率 Frequency : 40.000MHZ 7PF \pm 10PPM

制造商 Manufacturer : 浙江蓝晶芯微电子有限公司

提交时间 Date : 2023-08-04

制作 DESIGNER	审核 Checked	批准 Approved
赵倩	林本锦	孙娟

客户批准 Customer Approval :

审核 Checked	批准 Approved

(请批准后回签一份 PLEASE RETURN A COPY WITH APPROVAL)



LUCKI CM ELECTRONICS Co.,Ltd



修改记录
Revision History

修改号 No.	修订日期 Revised Date	修改内容 Change Content	修改人 modifier	批准人 Approved



LUCKI CM ELECTRONICS Co.,Ltd



规格内容 Specification content

NO.	Content	Page
1	电性能 Electrical characteristics	4
2	外形尺寸 Overall dimensions	5
3	印字标准 Marking specification	5
4	等效电路图 Equivalent Circuit	5
5	内部结构图 Structure drawing	6
6	可靠性规范 Reliability Specification	7
7	编带类型与卷盘 Type & Reel	8
8	包装说明 Packing Specification	9



LUCKI CM ELECTRONICS Co.,Ltd



1. 电性能 Electrical characteristics

Items	Symbol	Specification			Unit	Notes
		Min	Typ	Max		
型号名称 Model No		Seam Seal 2016				
晶片切型 Blank Cutting Mode		AT FUND.				
标称频率 Nominal Frequency	F0	40.000000			MHz	
振动模式 Oscillation Mode		■ Fundamental □3rd				
频差公差 Frequency Tolerance	$\Delta F/F0$	-10		10	ppm	25°C ± 3°C
负载电容 (CL) Load Capacitance	CL		7		pF	
工作温度条件下的频差 Frequency Stability	TC	-10		10	ppm	
工作温度 Operating Temperature	Topr	-20		75	°C	
存储温度范围 Storage Temperature	Tstg	-55	~	125	°C	
驱动功率 Drive Level	DL	10	100	300	uW	
等效串联电阻 Effective Resistance RR	Rr	-	-	40	Ω	
静态电容(C0) Shunt Capacitance C0	C0	-	-	2	pF	
频率牵引灵敏度 Trim Sensitivity TS	TS	-	-	-	ppm/PF	
绝缘阻抗 Insulation Resistance	IR	500	-	-	MΩ	at DC 100 V
年化率 Aging	Fa	-2		2	ppm	Per year
重量 Weight			0.0062		g	

测量设备 Measure equipment: S&A 250B

测量条件 Measurement conditions: 温度 23°C±3°C
湿度 30%RH -60%RH



LUCKI CM ELECTRONICS Co.,Ltd



2.外形尺寸 Overall dimensions

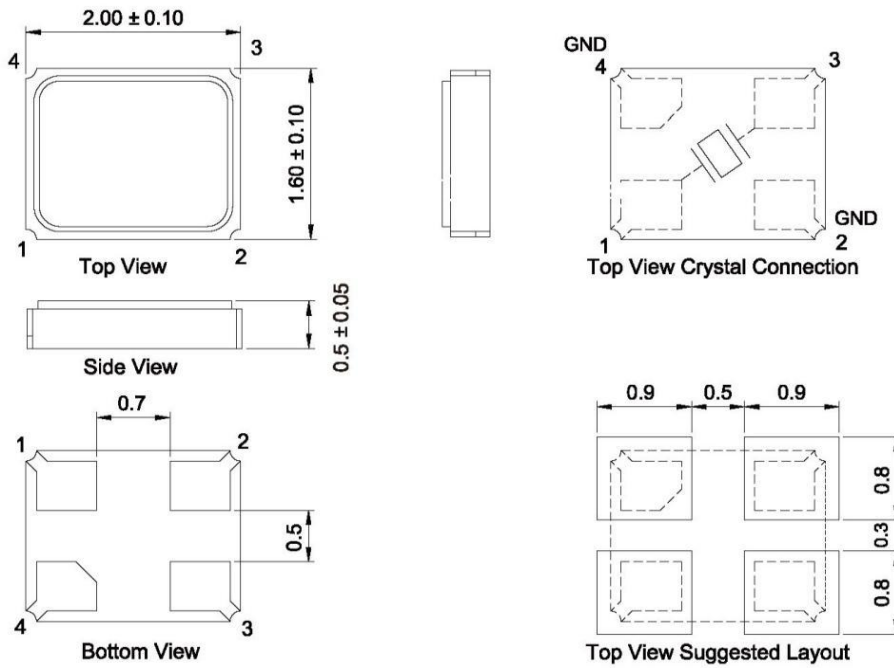

3. 印字标准 Marking specification

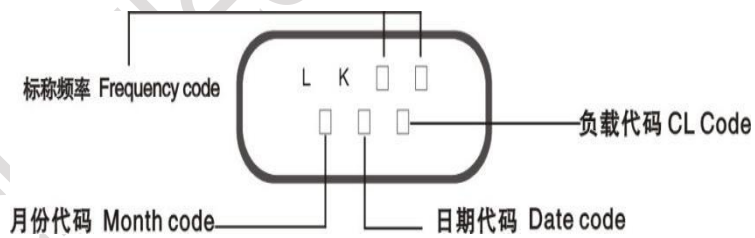

4. 等效电路图 Equivalent Circuit

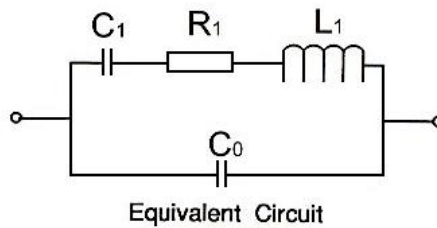

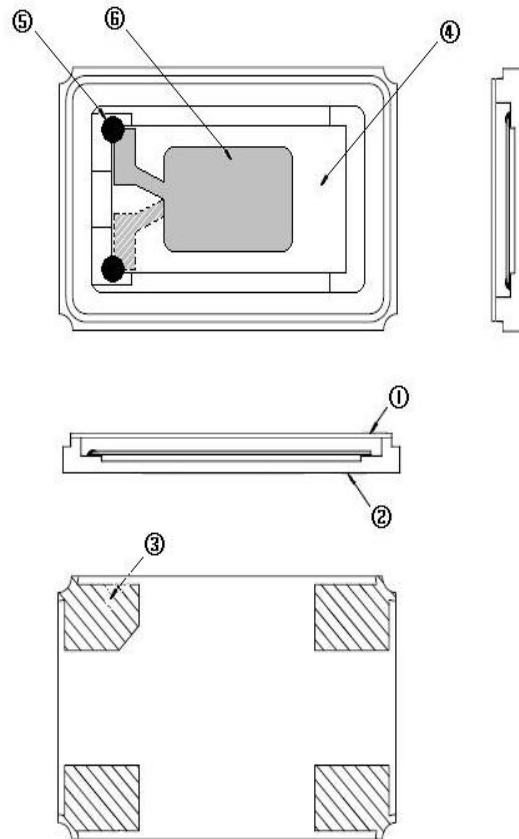
5. 内部结构图 Structure drawing

NO.	组件 COMPONENTS	材料成份 MATERIALS	数量 QTY
1	上盖 LID	KV 合金 KV(Fe/Co/Ni)	1
2	基座 Package	陶瓷 Ceramic	1
3	引脚 PAD	金 Au	4
4	晶片 Crystal Blank	贵金属银 Noble Metal(Ag)	1
5	导电胶 Conductive Adhesive	树脂、银粉 Resin、Ag	4
6	电极 Electrode	贵金属银 Noble Metal(Ag)	2



LUCKI CM ELECTRONICS Co.,Ltd



6. 可靠性规范 Reliability Specification

NO.	试验项目 Test item	试验方法 Test Methods	判定标准 Judgment criteria
1	跌落试验 Shock	高度: 100cm,硬质木版: 3cm,自然落下 3 回 Height:100cm,Wooden block:3cm, Dropping times:3 times	$\Delta F/F \leq 5.0\text{ppm}$ $\Delta CI \leq 5\Omega$ or 20%
2	耐振动性 Vibration	振幅: 1.5mm,周波数: 10Hz-55Hz,方向: X,Y,Z, 周期: 2h Amplitude:1.5mm,Frequency:10~55Hz,Direction:X.Y.Z,P eriod:2hours	$\Delta F/F \leq 5.0\text{ppm}$ $\Delta CI \leq 5\Omega$ or 20%
3	回流焊 Reflow		$\Delta F/F \leq 5.0\text{ppm}$ $\Delta CI \leq 5\Omega$ or 20%
4	耐湿试验 Humidity	温度: $65^{\circ}\text{C} \pm 2^{\circ}\text{C}$,湿度: 90%~95% 时间: 48 h Temperature: $65^{\circ}\text{C} \pm 2^{\circ}\text{C}$,Humidity:90%~95%,Period:48h	$\Delta F/F \leq 5.0\text{ppm}$ $\Delta CI \leq 5\Omega$ or 20%
5	低温保存试验 Low Temperature	温度: $-40^{\circ}\text{C} \pm 2^{\circ}\text{C}$ 时间: 2h Temperature: $-40^{\circ}\text{C} \pm 2^{\circ}\text{C}$ Period:2h	$\Delta F/F \leq 5.0\text{ppm}$ $\Delta CI \leq 5\Omega$ or 20%
6	高温保存试验 High Temperature	温度: $85^{\circ}\text{C} \pm 2^{\circ}\text{C}$ 时间: 16h Temperature: $85^{\circ}\text{C} \pm 2^{\circ}\text{C}$ Period:16h	$\Delta F/F \leq 5.0\text{ppm}$ $\Delta CI \leq 5\Omega$ or 20%
7	热冲击试验 Temperature Cycle	1 个循环: -40°C (30min) $\rightarrow 85^{\circ}\text{C}$ (30min) 30 个循环 1cycle: -40°C (30min) $\rightarrow 85^{\circ}\text{C}$ (30min) 30cycle	$\Delta F/F \leq 5.0\text{ppm}$ $\Delta CI \leq 5\Omega$ or 20%
8	折弯测试 Substrate Bending Test	弯曲量 :3mm , 受力: 10 秒, 速度 0.5mm/s. Bend Amount : 3 mm Force:10 second by 0.5mm/s speed.	$\Delta F/F \leq 5.0\text{ppm}$ $\Delta CI \leq 5\Omega$ or 20%
9	密封性 Sealing Test	氦气压力标准: 5.0~5.5Kg/cm ² , 加压时间: 2 小时 HELIUM BOMBING 5.0 ~ 5.5 Kg / cm ² ,FOR 2 HOURS.	Leak rate less than: $< 1 \cdot 0\text{E}-9 \text{ Pa} \cdot \text{m}^3/\text{sec}$ 泄漏率: $< 1 \cdot 0\text{E}-9 \text{ Pa} \cdot \text{m}^3/\text{sec}$
10	焊锡试验 Soldering Dip	温度: $+260^{\circ}\text{C} \pm 5^{\circ}\text{C}$ 时间: 3 sec Temperature: $+260^{\circ}\text{C} \pm 5^{\circ}\text{C}$ Period: 3 second	浸入端至少 95%面积覆盖着新的焊接材料.



LUCKI CM ELECTRONICS Co.,Ltd



7. 编带类型与卷盘 Type & Reel

	HC-49SMD	7050	6035	5032	3225	2520	2016
W	24.00±0.30	16.00±0.05	12.00±0.05	12.00±0.05	8.00±0.05	8.00±0.05	8.00±0.05
E	1.75±0.10	1.75±0.10	1.75±0.10	1.75±0.10	1.75±0.10	1.75±0.10	1.75±0.10
F	11.5±0.10	7.5±0.10	5.5±0.10	5.5±0.10	3.5±0.05	3.5±0.05	3.5±0.05
T	0.40±0.05	0.35±0.05	0.35±0.05	0.30±0.05	0.25±0.03	0.25±0.03	0.25±0.03
P	12.00±0.10	8.00±0.10	8.00±0.10	8.00±0.10	4.00±0.05	4.00±0.05	4.00±0.05
P0	4.00±0.10	4.00±0.10	4.00±0.10	4.00±0.10	4.00±0.05	4.00±0.05	4.00±0.05
P2	2.00±0.10	2.00±0.10	2.00±0.10	2.00±0.10	2.00±0.05	2.00±0.05	2.00±0.05
D0	φ1.50±0.10	φ1.50±0.10	φ1.50±0.10	φ1.50±0.10	φ1.50±0.10	φ1.50±0.10	φ1.50±0.10
D1	φ1.50MIN	φ1.50MIN	φ1.50MIN	φ1.50MIN	φ1.00MIN	φ1.00MIN	φ1.00MIN
A0	4.60±0.10	5.40±0.10	3.90±0.10	3.50±0.10	2.70±0.10	2.4±0.10	2.00±0.10
K0	4.40±0.10	1.80±0.10	1.50±0.10	1.60±0.10	1.50±0.10	1.10±0.10	1.10±0.10
B0	14.20±0.15	7.40±0.10	6.40±0.10	5.20±0.10	3.50±0.05	2.90±0.05	2.4±0.05

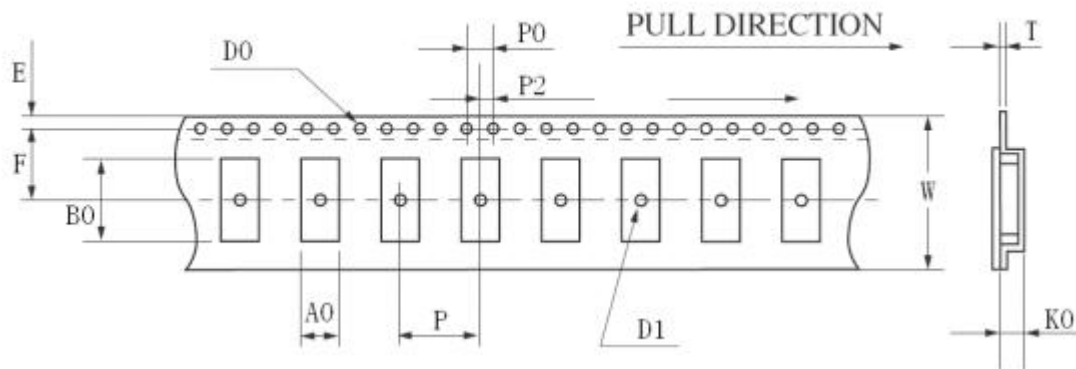

3000pc/reel

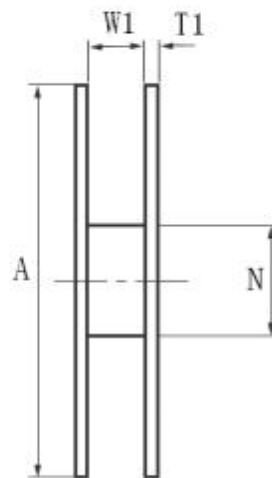
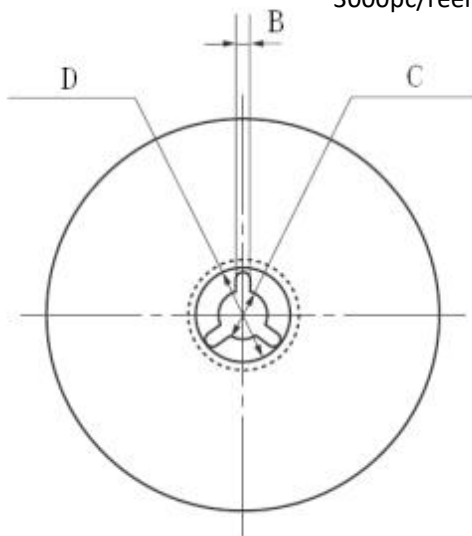



LUCKI CM ELECTRONICS Co.,Ltd



	HC-49SMD	7050	6035	5032	3225	2520	2016
A	$\phi 330 \pm 1.0$	$\phi 178 \pm 2.0$	$\phi 178 \pm 2.0$	$\phi 178 \pm 2.0$	$\phi 178 \pm 2.0$	$\phi 178 \pm 2.0$	$\phi 178 \pm 2.0$
B	2.30 ± 0.20	2.00 ± 0.50	2.00 ± 0.50	2.00 ± 0.50	2.50 ± 0.50	2.50 ± 0.50	2.50 ± 0.50
C	$\phi 13.5 \pm 0.20$	$\phi 13.2 \pm 0.20$	$\phi 13.2 \pm 0.20$	$\phi 13.2 \pm 0.20$	$\phi 13.5 \pm 0.20$	$\phi 13.5 \pm 0.20$	$\phi 13.5 \pm 0.20$
D	$\phi 21.5 \pm 0.20$	$\phi 20.0 \pm 0.50$	$\phi 20.0 \pm 0.50$	$\phi 20.0 \pm 0.50$	$\phi 56.8 \pm 0.50$	$\phi 56.8 \pm 0.50$	$\phi 56.8 \pm 0.50$
N	$\phi 100.0 \pm 0.5$	$\phi 60.5 \pm 1.0$	$\phi 60.5 \pm 1.0$	$\phi 60.5 \pm 1.0$	$\phi 60.5 \pm 1.0$	$\phi 60.5 \pm 1.0$	$\phi 60.5 \pm 1.0$
W1	24.5 ± 0.20	16.5 ± 0.20	12.5 ± 0.20	12.5 ± 0.20	9.4 ± 0.30	8.0 ± 0.30	8.0 ± 0.30
T1	2.30 ± 0.20	1.80 ± 0.20	1.80 ± 0.20	1.80 ± 0.20	1.40 ± 0.20	1.40 ± 0.20	1.40 ± 0.20

8. 包装说明 Packing Specification

