

MCR12DCM, MCR12DCN

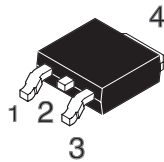

Pin Out



Description

This thyristor is designed primarily for half-wave ac control applications, such as motor controls, heating controls, and power supplies; or wherever half-wave, silicon gate-controlled devices are needed.

Features

- Small Size
- Passivated Die for Reliability and Uniformity
- Low Level Triggering and Holding Characteristics
- UL Recognized compound meets flammability rating V-0.
- ESD Ratings: Human Body Model, 3B > 8000 V
Machine Model, C > 400 V
- Pb-Free Packages are Available

Functional Diagram



Additional Information



Datasheet



Resources



Samples

Maximum Ratings ($T_J = 25^\circ\text{C}$ unless otherwise noted)

Rating	Symbol	Value	Unit
Peak Repetitive Off-State Voltage (Note 1) (– 40 to 110°C, Sine Wave, 50 to 60 Hz, Gate Open)	MCR12DCM	V_{DRM}	600
	MCR12DCN	V_{RRM}	800
On-State RMS Current (180° Conduction Angles; $T_C = 90^\circ\text{C}$)	$I_{T(RMS)}$	12	A
Average On-State Current (180° Conduction Angles; $T_C = 90^\circ\text{C}$)	$I_{T(AV)}$	7.8	A
Peak Non-Repetitive Surge Current (1/2 Cycle, Sine Wave 60 Hz, $T_J = 125^\circ\text{C}$)	I_{TSM}	100	A
Circuit Fusing Consideration ($t = 8.3$ ms)	I^2t	41	A ² sec
Forward Peak Gate Power (Pulse Width ≤ 10 μsec , $T_C = 90^\circ\text{C}$)	P_{GM}	5.0	W
Forward Average Gate Power ($t = 8.3$ msec, $T_C = 90^\circ\text{C}$)	$P_{GM(AV)}$	0.5	W
Forward Peak Gate Current (Pulse Width ≤ 1.0 μsec , $T_C = 90^\circ\text{C}$)	I_{GM}	2.0	A
Operating Junction Temperature Range	T_J	–40 to 125	°C
Storage Temperature Range	T_{stg}	–40 to 150	°C

Maximum ratings are those values beyond which component damage can occur. Maximum ratings applied to the device are individual stress limit values (not normal operating conditions) and are not valid simultaneously. If these limits are exceeded, component functional operation is not implied, damage may occur and reliability may be affected.

1. V_{DRM} and V_{RRM} for all types can be applied on a continuous basis. Ratings apply for zero or negative gate voltage; however, positive gate voltage shall not be applied concurrent with negative potential on the anode. Blocking voltages shall not be tested with a constant current source such that the voltage ratings of the devices are exceeded.

Thermal Characteristics

Rating	Symbol	Value	Unit
Thermal Resistance, Junction-to-Case	$R_{\theta JC}$	2.2	°C/W
Thermal Resistance, Junction-to-Ambient	$R_{\theta JA}$	88	
Thermal Resistance, Junction-to-Ambient (Note 2)	$R_{\theta JA}$	80	
Maximum Lead Temperature for Soldering Purposes 1/8" from Case for 10 Seconds	T_L	260	°C

Electrical Characteristics - OFF ($T_J = 25^\circ\text{C}$ unless otherwise noted)

Characteristic	Symbol	Min	Typ	Max	Unit
Peak Repetitive Forward or Reverse Blocking Current ($V_{AK} = \text{Rated } V_{DRM}$ or V_{RRM} , Gate Open)	I_{DRM} I_{RRM}	$T_J = 25^\circ\text{C}$	–	–	0.01
		$T_J = 125^\circ\text{C}$	–	–	5.0

Electrical Characteristics - ON ($T_J = 25^\circ\text{C}$ unless otherwise noted; Electricals apply in both directions)

Characteristic	Symbol	Min	Typ	Max	Unit
Peak Forward On-State Voltage (Note 2) ($I_{TM} = 16$ A)	V_{TM}	–	1.3	1.9	V
Gate Trigger Current (Continuous dc) ($V_D = 12$ V; $R_L = 100$ Ω)	I_{GT}	$T_J = 25^\circ\text{C}$	2.0	7.0	20
		$T_J = -40^\circ\text{C}$	–	–	40
Gate Trigger Voltage (Continuous dc) ($V_D = 12$ V, $R_L = 100$ Ω)	V_{GT}	$T_J = 25^\circ\text{C}$	0.5	0.65	1.0
		$T_J = -40^\circ\text{C}$	–	–	2.5
Gate Non-Trigger Voltage ($V_D = 12$ V, $R_L = 100$ Ω)	V_{GD}	0.2	–	–	V
Holding Current ($V_D = 12$ V, Gate Open, Initiating Current = 200 mA)	I_H	$T_J = 25^\circ\text{C}$	4.0	22	40
		$T_J = -40^\circ\text{C}$	–	–	80
Latch Current ($V_D = 12$ V, $I_G = 20$ μA , $T_J = 25^\circ\text{C}$) ($V_D = 12$ V, $I_G = 40$ μA , $T_J = -40^\circ\text{C}$)	I_L	$T_J = 25^\circ\text{C}$	4.0	22	40
		$T_J = -40^\circ\text{C}$	–	–	80

Dynamic Characteristics

Characteristic	Symbol	Min	Typ	Max	Unit
Critical Rate of Rise of Off-State Voltage ($V_D = \text{Rated } V_{DRM}$ Exponential Waveform, Gate Open, $T_J = 125^\circ\text{C}$)	dv/dt	50	200	-	V/ μs

- 2. These ratings are applicable when surface mounted on the minimum pad sizes recommended.
- 3. 1/8" from case for 10 seconds.
- 4. Pulse Test: Pulse Width ≤ 2.0 msec, Duty Cycle $\leq 2\%$.

Voltage Current Characteristic of SCR

Symbol	Parameter
V_{DRM}	Peak Repetitive Forward Off State Voltage
I_{DRM}	Peak Forward Blocking Current
V_{RRM}	Peak Repetitive Reverse Off State Voltage
I_{RRM}	Peak Reverse Blocking Current
V_{TM}	Maximum On State Voltage
I_H	Holding Current

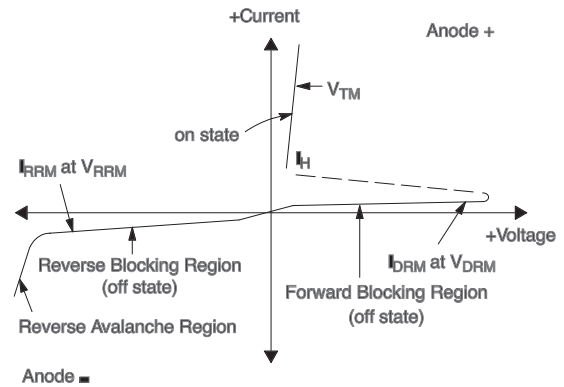

Figure 1. Average RMS Current Derating

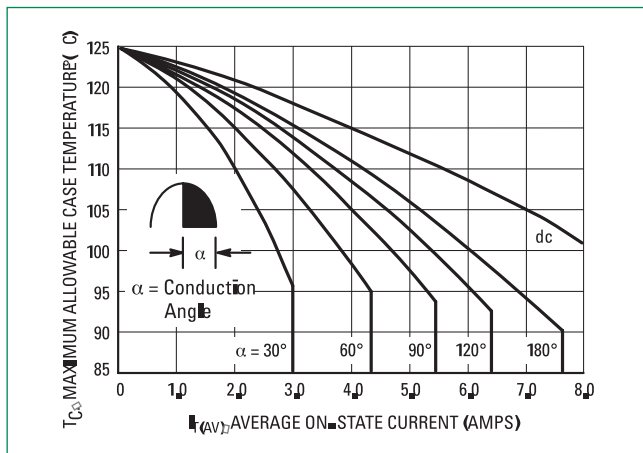

Figure 2. On-State Power Dissipation

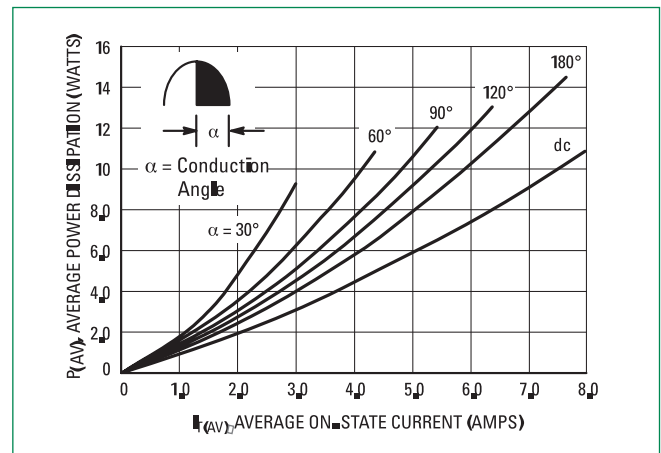

Figure 3. On-State Characteristics

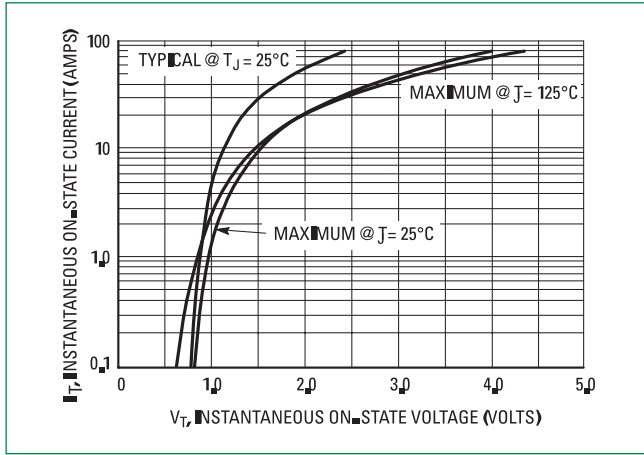

Figure 4. Transient Thermal Response

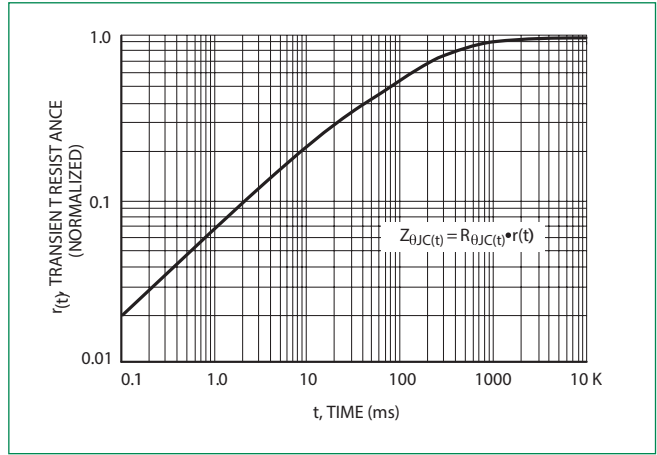

Figure 5. Typical Gate Trigger Current vs Junction Temperature

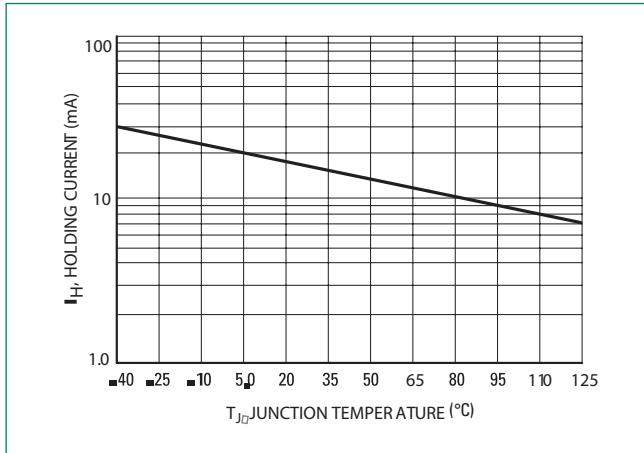

Figure 6. Typical Gate Trigger Voltage vs Junction Temperature

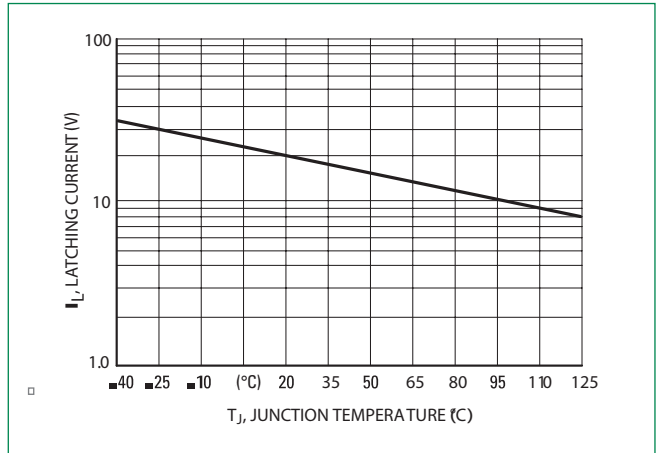

Figure 7. Typical Holding Current vs Junction Temperature

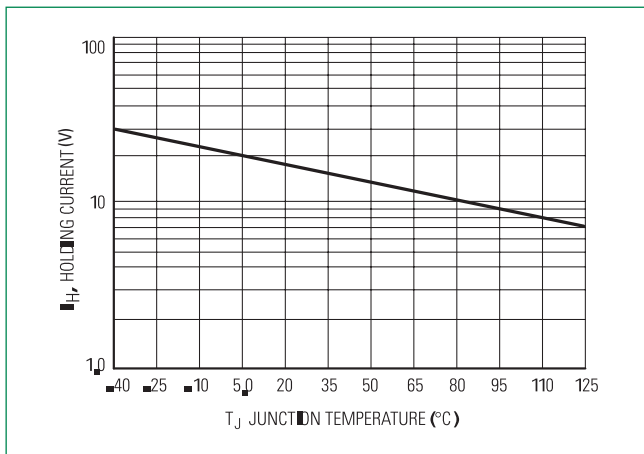
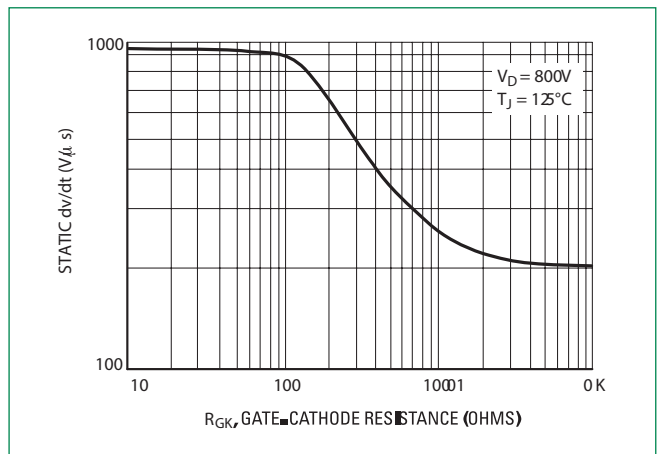
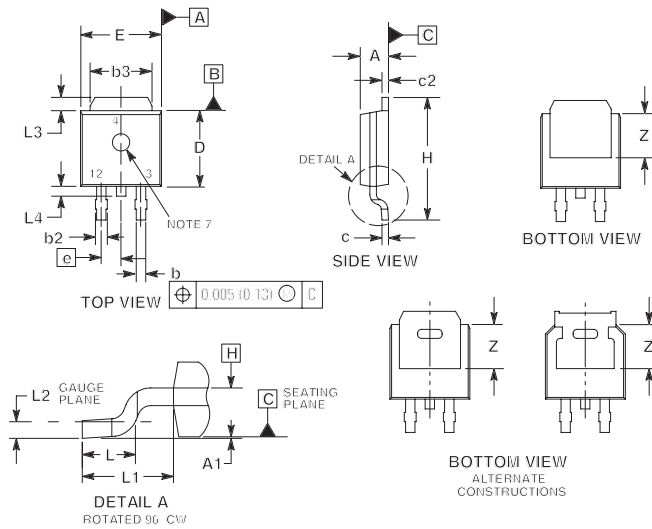

Figure 9. Exponential Static dv/dt vs Gate-Cathode Resistance



Dimensions



Dim	Inches		Millimeters	
	Min	Max	Min	Max
A	0.087	0.094	2.20	2.40
A1	0.000	0.005	0.00	0.12
b	0.022	0.030	0.55	0.75
b2	0.026	0.033	0.65	0.85
b3	0.209	0.217	5.30	5.50
c	0.019	0.023	0.49	0.59
c2	0.019	0.023	0.49	0.59
D	0.213	0.224	5.40	5.70
E	0.252	0.260	6.40	6.60
e	0.091		2.30	
H	0.374	0.406	9.50	10.30
L	0.058	0.070	1.47	1.78
L1	0.114		2.90	
L2	0.019	0.023	0.49	0.59
L3	0.053	0.065	1.35	1.65
L4	0.028	0.039	0.70	1.00
Z	0.154	-	3.90	-

1. DIMENSIONING AND TOLERANCING PER ANSI Y14.5M, 1982.

2. CONTROLLING DIMENSION: INCH.

Part Marking System

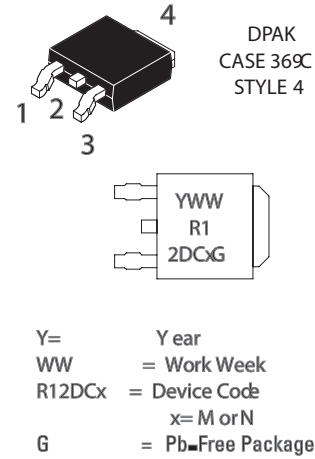

Pin Assignment

1	Cathode
2	Anode
3	Gate
4	Anode

Ordering Information

Device	Package	Shipping
MCR12DCMT4	DPAK	2500 / Tape & Reel
MCR12DCMT4G	DPAK (Pb-Free)	
MCR12DCNT4	TO-220AB	
MCR12DCNT4G	DPAK (Pb-Free)	

Disclaimer Notice - Information furnished is believed to be accurate and reliable. However, users should independently evaluate the suitability of and test each product selected for their own applications. Littelfuse products are not designed for, and may not be used in, all applications. Read complete Disclaimer Notice at: www.littelfuse.com/disclaimer-electronics