

## TPS62843 1.8V 至 5.5V、600mA、275nA I<sub>Q</sub> 小型降压转换器

### 1 特性

- 输入电压范围为 1.8V 至 5.5V
- 0.4V 至 3.6V 输出电压范围
- 275nA 静态电流 (典型值)
- 输出电流为 600mA
- 1% 的输出电压精度
- 关断电流典型值为 4nA
- 输出放电
- 通过单个电阻器实现 VSET 引脚可选输出电压
  - TPS628436 : 0.4V 至 0.8V
  - TPS628437 : 0.8V 至 1.8V
  - TPS628438 : 1.8V 至 3.6V
- 针对小型无源器件进行了优化
  - 1  $\mu$ H 电感器
  - 低至 4.7  $\mu$ F C<sub>OUT</sub>
- 在省电模式下具有低输出电压纹波
- 射频友好型快速瞬态 DCS-Control
- 自动转换至无纹波 100% 模式
- 支持 0603 电感器和 0402 电感器
- 0.84mm<sup>2</sup> 尺寸的微型 6 引脚 0.35mm 间距 W CSP 封装
- 与 TPS6280x 系列 (1A) 引脚对引脚兼容

### 2 应用

- 可穿戴电子产品
- 耳麦、耳机和耳塞
- 手机
- 医疗传感器贴片
- 助听器

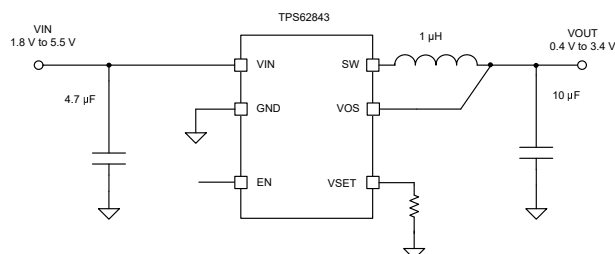

典型应用

### 3 说明

TPS62843 是一款高效降压转换器，具有典型值为 275nA 的超低工作静态电流。该器件在禁用状态时具有 4nA (典型值) 关断电流。

此器件采用 DCS-Control 技术，具有射频友好型低输出电压纹波，可以为无线电提供电源。

此器件采用 1.5MHz 的典型开关频率，可在低至 100  $\mu$ A 负载电流及以下的轻负载条件下提供高效率。

通过将一个电阻器连接到 VSET 引脚，可选择 18 种预定义的输出电压，因此只需很少的无源器件即可将该系列器件用于各种应用。

器件信息

器件型号	V <sub>OUT</sub> 范围	封装 <sup>(1)</sup>	封装尺寸 (标称值)
TPS628436	0.4V 至 0.8V	YKA (DSBGA , 6)	0.80mm ×
TPS628437	0.8V 至 1.8V		1.05mm ×
TPS628438	1.8V 至 3.6V		0.40mm

(1) 如需了解所有可用封装，请参阅数据表末尾的可订购产品附录。

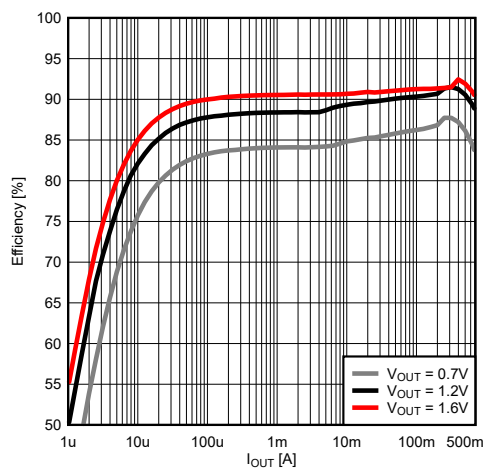

效率与输出电流间的关系曲线 (电压为 3.6V<sub>IN</sub> 时)



## Table of Contents

<b>1 特性</b> .....	<b>1</b>	8.3 Feature Description.....	<b>9</b>
<b>2 应用</b> .....	<b>1</b>	8.4 Device Functional Modes.....	<b>11</b>
<b>3 说明</b> .....	<b>1</b>	<b>9 Application and Implementation</b> .....	<b>12</b>
<b>4 Revision History</b> .....	<b>2</b>	9.1 Application Information.....	<b>12</b>
<b>5 Device Comparison Table</b> .....	<b>3</b>	9.2 Typical Application.....	<b>12</b>
<b>6 Pin Configuration and Functions</b> .....	<b>3</b>	9.3 Power Supply Recommendations.....	<b>17</b>
<b>7 Specifications</b> .....	<b>4</b>	9.4 Layout.....	<b>17</b>
7.1 Absolute Maximum Ratings.....	<b>4</b>	<b>10 Device and Documentation Support</b> .....	<b>19</b>
7.2 ESD Ratings.....	<b>4</b>	10.1 Device Support.....	<b>19</b>
7.3 Recommended Operating Conditions.....	<b>4</b>	10.2 接收文档更新通知.....	<b>19</b>
7.4 Thermal Information.....	<b>5</b>	10.3 支持资源.....	<b>19</b>
7.5 Electrical Characteristics.....	<b>5</b>	10.4 Trademarks.....	<b>19</b>
7.6 Typical Characteristics.....	<b>7</b>	10.5 静电放电警告.....	<b>19</b>
<b>8 Detailed Description</b> .....	<b>8</b>	10.6 术语表.....	<b>19</b>
8.1 Overview.....	<b>8</b>	<b>11 Mechanical, Packaging, and Orderable</b>	
8.2 Functional Block Diagram.....	<b>8</b>	<b>Information</b> .....	<b>20</b>

## 4 Revision History

注：以前版本的页码可能与当前版本的页码不同

<b>Changes from Revision * (January 2022) to Revision A (May 2023)</b>	<b>Page</b>
• 将文档状态从“预告信息”更改为“量产数据” .....	<b>1</b>

## 5 Device Comparison Table

Device	Fixed $V_{OUT}$ $VSET = GND$	Selectable Output Voltages	$f_{sw}$ [MHz]	Soft Start $t_{SS}$	Inductor
TPS628436	1.0 V	0.4 V - 0.8 V in 25-mV steps	1.5	400 $\mu$ s	1 $\mu$ H
TPS628437	1.8 V	0.8 V - 1.6 V in 50-mV steps	1.5	800 $\mu$ s	1 $\mu$ H
TPS628438	3.6 V	1.8 V - 3.4 V in 100-mV steps	1.5	800 $\mu$ s	1 $\mu$ H

## 6 Pin Configuration and Functions



图 6-1. 6-Pin DSBGA YKA Package (Top View)

表 6-1. Pin Functions

PIN		TYPE	DESCRIPTION
NAME	NO.		
GND	A1	PWR	GND supply pin. Connect this pin close to the GND terminal of the input and output capacitor.
VIN	B1	PWR	$V_{IN}$ power supply pin. Connect the input capacitor close to this pin for best noise and voltage spike suppression. A ceramic capacitor is required.
VSET	C1	I	Connecting a resistor to GND selects a pre-defined output voltage.
VOS	A2	I	Output voltage sense pin for the internal feedback divider network and regulation loop. This pin also discharges $V_{OUT}$ by an internal MOSFET when the converter is disabled. Connect this pin directly to the output capacitor with a short trace.
SW	B2	O	The switch pin is connected to the internal MOSFET switches. Connect the inductor to this terminal.
EN	C2	I	A high level enables the devices and a low level turns the device off. The pin features an internal pulldown resistor, which is disabled once the device has started up.

## 7 Specifications

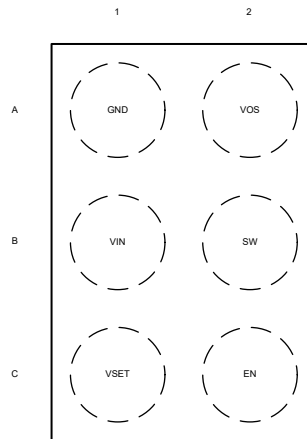
### 7.1 Absolute Maximum Ratings

Over operating junction temperature range (unless otherwise noted) <sup>(1)</sup>

		MIN	MAX	UNIT
Pin voltage	V <sub>IN</sub>	- 0.3	6	V
Pin voltage	SW, DC	- 0.3	V <sub>IN</sub> + 0.3 V	V
Pin voltage	SW, transient < 10 ns, while switching	- 2.5	9	V
Pin voltage	EN, VSET	- 0.3	6	V
Pin voltage	VOS	- 0.3	5	V
T <sub>J</sub>	Operating junction temperature	- 40	150	°C
T <sub>stg</sub>	Storage temperature	- 55	150	°C

- (1) Operation outside the Absolute Maximum Ratings may cause permanent device damage. Absolute Maximum Ratings do not imply functional operation of the device at these or any other conditions beyond those listed under Recommended Operating Conditions. If used outside the Recommended Operating Conditions but within the Absolute Maximum Ratings, the device may not be fully functional, and this may affect device reliability, functionality, performance, and shorten the device lifetime.

### 7.2 ESD Ratings

			VALUE	UNIT
V <sub>(ESD)</sub>	Electrostatic discharge	Human-body model (HBM), per ANSI/ESDA/JEDEC JS-001 <sup>(1)</sup>	±2000	V
		Charged-device model (CDM), per ANSI/ESDA/JEDEC JS-002 <sup>(2)</sup>	±500	

- (1) JEDEC document JEP155 states that 500-V HBM allows safe manufacturing with a standard ESD control process.  
 (2) JEDEC document JEP157 states that 250-V CDM allows safe manufacturing with a standard ESD control process.

### 7.3 Recommended Operating Conditions

		MIN	NOM	MAX	UNIT
V <sub>IN</sub>	Supply voltage V <sub>IN</sub>	1.8		5.5	V
I <sub>OUT</sub>	Output current			0.6	A
L	Effective inductance	0.7	1.0	1.2	μH
C <sub>OUT</sub>	Effective output capacitance	4		25	μF
C <sub>IN</sub>	Effective input capacitance	0.5	4.7		μF
C <sub>VSET</sub>	External parasitic capacitance at VSET pin			30	pF
R <sub>SET</sub>	Resistance range for external resistor at VSET pin (E96 1% resistor values)	10		249	kΩ
	External resistor tolerance E96 series at VSET pin			1%	
	E96 resistor series temperature coefficient (TCR)	- 200		+200	ppm/°C
T <sub>J</sub>	Operating junction temperature range	- 40		125	°C

## 7.4 Thermal Information

THERMAL METRIC <sup>(1)</sup>		YKA (DSBGA) 6 PINS	UNIT
R <sub>θJA</sub>	Junction-to-ambient thermal resistance	147.7	°C/W
R <sub>θJC(top)</sub>	Junction-to-case (top) thermal resistance	1.7	°C/W
R <sub>θJB</sub>	Junction-to-board thermal resistance	47.5	°C/W
ψ <sub>JT</sub>	Junction-to-top characterization parameter	0.5	°C/W
ψ <sub>JB</sub>	Junction-to-board characterization parameter	47.6	°C/W
R <sub>θJC(bot)</sub>	Junction-to-case (bottom) thermal resistance	-	°C/W

(1) For more information about traditional and new thermal metrics, see the [Semiconductor and IC Package Thermal Metrics](#) application report.

## 7.5 Electrical Characteristics

T<sub>J</sub> = -40°C to +125°C, V<sub>IN</sub> = 1.8 V to 5.5 V. Typical values are at T<sub>J</sub> = 25°C, V<sub>IN</sub> = 3.6 V and V<sub>OUT</sub> = 0.7 V (unless otherwise noted)

PARAMETER	TEST CONDITIONS	MIN	TYP	MAX	UNIT	
<b>SUPPLY</b>						
I <sub>Q</sub>	Operating Quiescent Current (Power Save Mode)	Non-switching, V <sub>EN</sub> = V <sub>IN</sub> , I <sub>OUT</sub> = 0 μA, T <sub>J</sub> = -40°C to 85°C		275	1500	nA
		Switching, V <sub>EN</sub> = V <sub>IN</sub> , I <sub>OUT</sub> = 0 μA, V <sub>OUT</sub> = 0.7 V		350		nA
I <sub>SD</sub>	Shutdown Current	V <sub>EN</sub> = 0 V, VSET = GND, T <sub>J</sub> = -40°C to 85°C		4	850	nA
<b>UVLO</b>						
V <sub>UVLO(R)</sub>	Undervoltage Lockout Rising Threshold	V <sub>IN</sub> rising, I <sub>OUT</sub> = 0 μA		1.75	1.8	V
V <sub>UVLO(F)</sub>	Undervoltage Lockout Falling Threshold	V <sub>IN</sub> falling, I <sub>OUT</sub> = 0 μA		1.65	1.7	V
V <sub>UVLO(H)</sub>	Undervoltage Lockout Hysteresis			100		mV
<b>VSET PIN</b>						
V <sub>SET(LKG)</sub>	VSET Input leakage current	T <sub>J</sub> = -40°C to 85°C		10	800	nA
V <sub>SET(H)</sub>	VSET High-level detection	Voltage at VSET during startup		1.0		V
R <sub>SET</sub>	RSET accuracy	T <sub>J</sub> = -20°C to 125°C		-4	4	%
R <sub>SET</sub>	RSET accuracy	T <sub>J</sub> = -40°C to 125°C		-3.5	3.5	%
<b>ENABLE</b>						
V <sub>EN(R)</sub>	EN voltage rising threshold	EN rising, enable switching		0.8		V
V <sub>EN(F)</sub>	EN voltage falling threshold	EN falling, disable switching			0.4	V
V <sub>EN(LKG)</sub>	EN Input leakage current	V <sub>EN</sub> > 0.8 V, T <sub>J</sub> = -40°C to 85°C		1	25	nA
R <sub>EN;PD</sub>	EN internal pull-down resistance	EN pin to GND		425	500	kΩ
<b>VOUT VOLTAGE</b>						
V <sub>OUT</sub>	DC Output voltage accuracy	PWM operation, T <sub>J</sub> = -20°C to 125°C		-1	+1	%
V <sub>OUT</sub>	DC Output voltage accuracy	PWM operation, T <sub>J</sub> = -40°C to 125°C		-1.5	+1.5	%
V <sub>OUT</sub>	TPS628436			0.4	0.8	V
	TPS628437			0.8	1.8	V
	TPS628438			1.8	3.6	V
I <sub>VOS(LKG)</sub>	VOS input leakage current	TPS628436, V <sub>EN</sub> = V <sub>IN</sub> , V <sub>VOS</sub> = 0.7 V, T <sub>J</sub> = -40°C to 85°C			100	nA
		TPS628437, V <sub>EN</sub> = V <sub>IN</sub> , V <sub>VOS</sub> = 1.2 V, T <sub>J</sub> = -40°C to 85°C		100	250	nA
		TPS628438, V <sub>EN</sub> = V <sub>IN</sub> , V <sub>VOS</sub> = 3.3 V, T <sub>J</sub> = -40°C to 85°C		275	450	nA
f <sub>sw</sub>		I <sub>OUT</sub> = 400 mA		1.5		MHz
<b>STARTUP</b>						

## 7.5 Electrical Characteristics (continued)

$T_J = -40^{\circ}\text{C}$  to  $+125^{\circ}\text{C}$ ,  $V_{IN} = 1.8\text{ V}$  to  $5.5\text{ V}$ . Typical values are at  $T_J = 25^{\circ}\text{C}$ ,  $V_{IN} = 3.6\text{ V}$  and  $V_{OUT} = 0.7\text{ V}$  (unless otherwise noted)

PARAMETER		TEST CONDITIONS	MIN	TYP	MAX	UNIT
$t_{SS}$	TPS628436 soft-start time	From $V_{OUT}=0\%$ to $V_{OUT}=95\%$ of $V_{OUT}$ nominal		0.45	0.6	ms
	TPS628438 soft-start time			1.0	1.4	
	TPS628437 soft-start time			0.7	1.0	
$t_{Startup\_delay}$	EN HIGH to start of switching delay	R2D = GND		330	560	$\mu\text{s}$
<b>POWER STAGE</b>						
$R_{DSON(HS)}$	High-side MOSFET on-resistance	$V_{IN} = 3.6\text{ V}$ , $I_{OUT} = 300\text{ mA}$		170	260	$\text{m}\Omega$
$R_{DSON(LS)}$	Low-side MOSFET on-resistance	$V_{IN} = 3.6\text{ V}$ , $I_{OUT} = 300\text{ mA}$		70	115	$\text{m}\Omega$
$I_{LKG\_SW}$	Leakage Current into SW-Pin	$V_{SW} = 0.7\text{ V}$ , $T_J = -40^{\circ}\text{C}$ to $85^{\circ}\text{C}$		0	35	nA
$I_{LKG\_SW}$	Leakage Current into SW-Pin	$V_{SW} = 1.2\text{ V}$ , $T_J = -40^{\circ}\text{C}$ to $85^{\circ}\text{C}$		0	45	nA
$I_{LKG\_SW}$	Leakage Current into SW-Pin	$V_{VIN} > V_{SW}$ , $V_{SW} = 3.3\text{ V}$ , $T_J = -40^{\circ}\text{C}$ to $85^{\circ}\text{C}$		0	45	nA
<b>OVERCURRENT PROTECTION</b>						
$I_{HS(OC)}$	High-side peak current limit	$V_{IN} \cong 2.2\text{ V}$	0.9	1.1	1.3	A
$I_{LS(OC)}$	Low-side valley current limit	$V_{IN} \cong 2.2\text{ V}$	0.79	1.0	1.11	A
<b>OUTPUT DISCHARGE</b>						
$R_{DSCH\_VOS}$	Output discharge resistor on VOS pin	$V_{EN} = \text{GND}$ , $I(\text{VOS}) = -10\text{ mA}$		7	22	$\Omega$
<b>THERMAL SHUTDOWN</b>						
$T_{J(SD)}$	Thermal shutdown threshold	Temperature rising		160		$^{\circ}\text{C}$
$T_{J(HYS)}$	Thermal shutdown hysteresis			20		$^{\circ}\text{C}$

## 7.6 Typical Characteristics



图 7-1. Shutdown Current  $I_{SD}$



图 7-2. Quiescent Current  $I_Q$

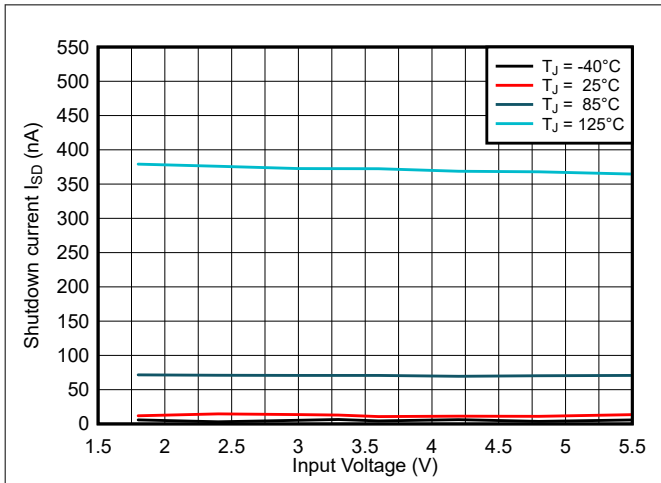

图 7-3. High Side Switch Drain Source Resistance  $R_{DS(ON)}$

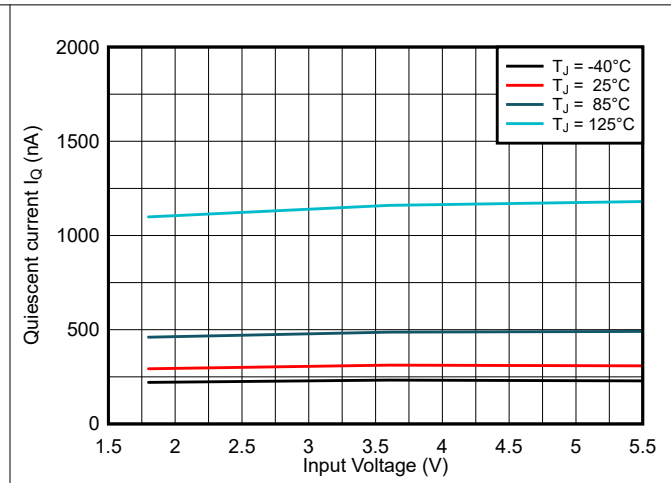

图 7-4. Low Side Switch Drain Source Resistance  $R_{DS(ON)}$

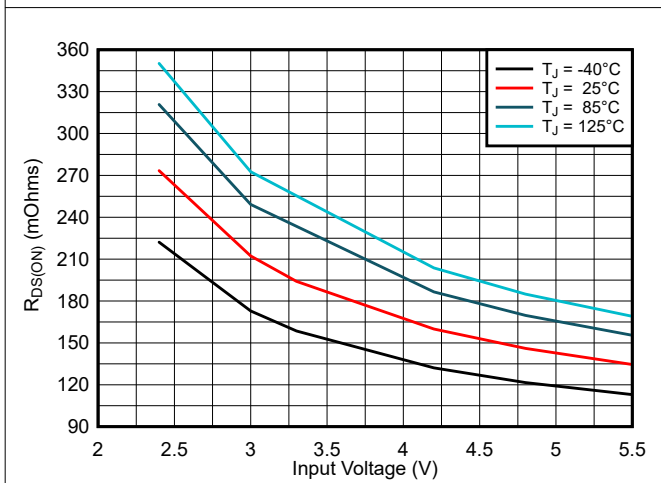

图 7-5. VOS Discharge Switch Drain Source Resistance  $R_{DIS}$

## 8 Detailed Description

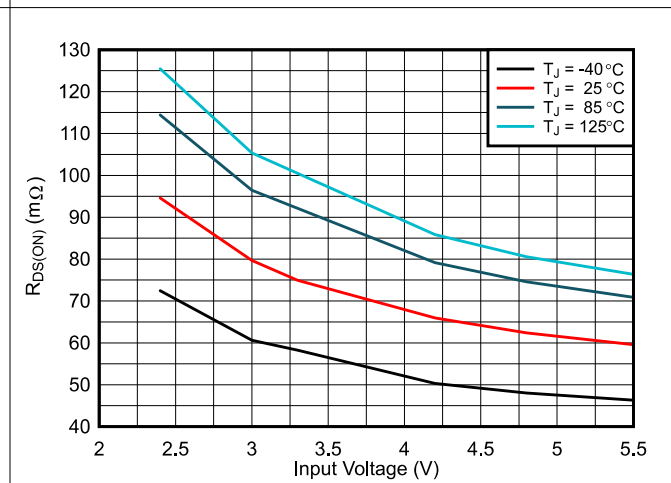
### 8.1 Overview

The TPS62843 is a high-frequency, synchronous step-down converter with ultra-low quiescent current of typically 275 nA in a 0.84-mm<sup>2</sup> chip size. The device operates with a tiny 1- $\mu$ H inductor and 10- $\mu$ F output capacitor over the entire recommended operation range to provide one of the industry's smallest chip and solution size.

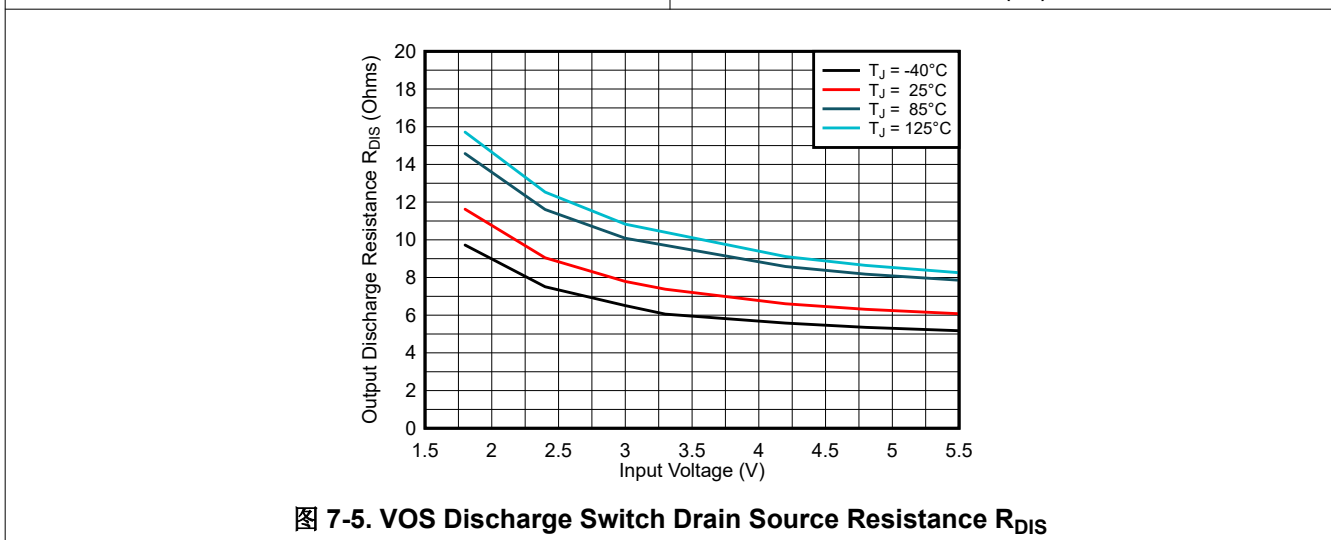
Using TI's DCS-Control topology, the device extends the high efficiency operation area down to microamperes of load current during power save mode operation. TI's DCS-Control (Direct Control with Seamless Transition into power save mode) is an advanced regulation topology that combines the advantages of hysteretic and voltage mode control. Characteristics of DCS-Control are excellent AC load regulation and transient response, low output ripple voltage, and a seamless transition between PFM and PWM mode operation. DCS-Control includes an AC loop that senses the output voltage (VOS pin) and directly feeds the information to a fast comparator stage. This comparator sets the switching frequency, which is constant for steady state operating conditions, and provides immediate response to dynamic load changes. To achieve accurate DC load regulation, a voltage feedback loop is used. The internally compensated regulation network achieves fast and stable operation with small external components and low-ESR capacitors.

### 8.2 Functional Block Diagram

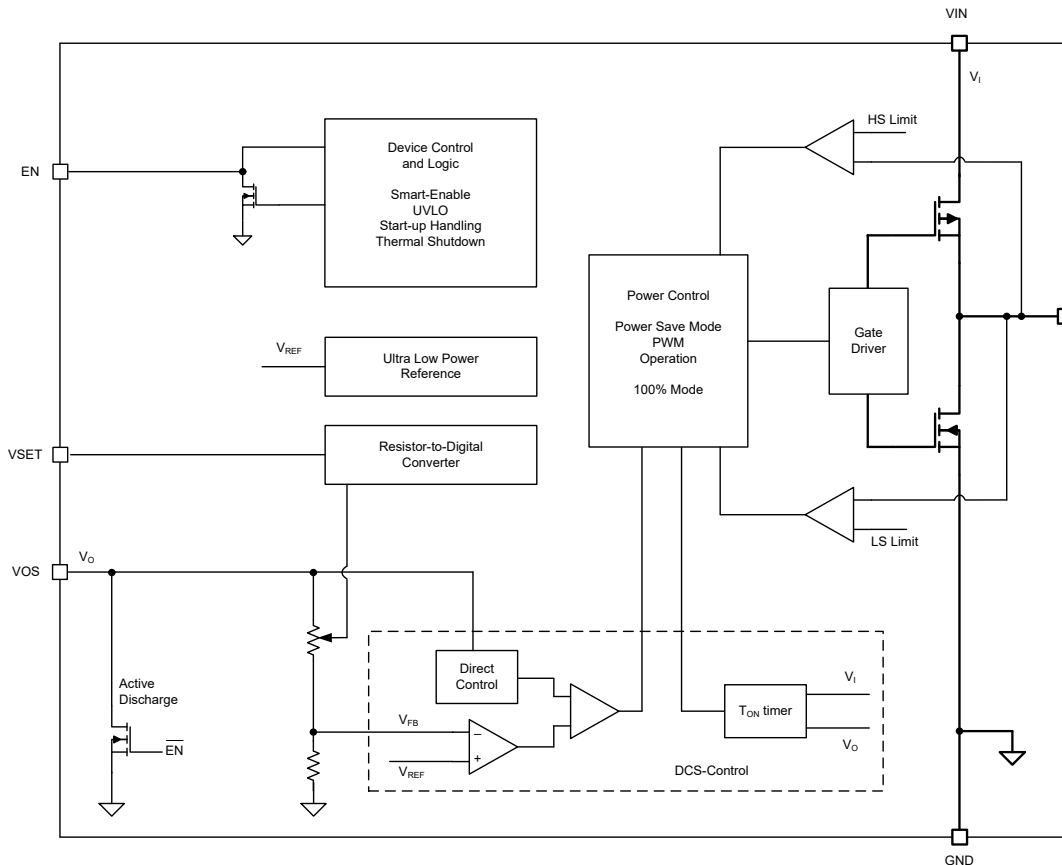



## 8.3 Feature Description

### 8.3.1 Smart Enable and Shutdown (EN)

An internal 500-k $\Omega$  resistor pulls the EN pin to GND and avoids floating the pin. This action prevents an uncontrolled start-up of the device in case the EN pin cannot be driven to low level safely. With EN low, the device is in shutdown mode. The device is turned on with EN set to a high level. The pulldown control circuit disconnects the pulldown resistor on the EN pin once the internal control logic and the reference have been powered up. With EN set to a low level, the device enters shutdown mode and the pulldown resistor is activated again.

### 8.3.2 Soft Start

After the device has been enabled with EN high, the device initializes and powers up its internal circuits. This action occurs during the regulator start-up delay time,  $t_{\text{Startup\_delay}}$ . After  $t_{\text{Startup\_delay}}$  expires, the internal soft-start circuitry ramps up the output voltage within the soft-start time,  $t_{\text{SS}}$ . See [图 8-1](#).

The start-up delay time,  $t_{\text{Startup\_delay}}$ , varies depending on the selected VSET value. The start-up delay is shortest with VSET = 0 and longest with VSET = 16.

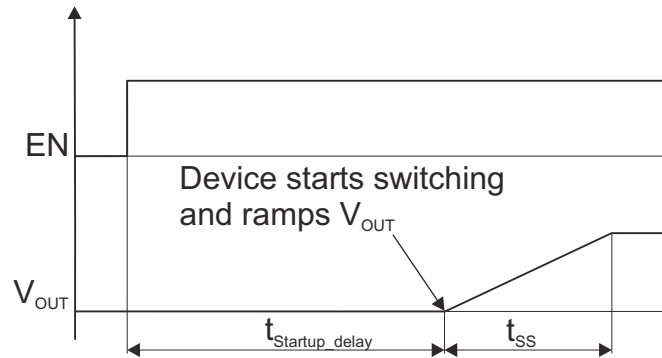

**图 8-1. Device Start-Up**

### 8.3.3 VSET Pin: Output Voltage Selection

The output voltage is set with a single external resistor connected between the VSET pin and GND. After the device has been enabled and the control logic as well as the internal reference have been powered up, a R2D (resistor-to-digital) conversion is started to detect the external resistor,  $R_{\text{SET}}$ , within the regulator start-up delay time,  $t_{\text{Startup\_delay}}$ . An internal current source applies current through the external resistor and an internal ADC reads back the resulting voltage level. Depending on the level, an internal feedback divider network is selected to set the correct output voltage. After this R2D conversion is finished, the current source is turned off to avoid current flow through the external resistor. The circuit can detect resistive values, high-level, low-level, and a pin-open.

For a proper reading, ensure that there is no additional current path or capacitance greater than 30 pF total to GND during R2D conversion. Otherwise, the additional current to GND is interpreted as a lower resistor value and a false output voltage is set. [表 8-1](#) lists the correct resistor values for  $R_{\text{SET}}$  to set the appropriate output voltages. The R2D converter is designed to operate with resistor values out of the E96 table and requires 1% resistor value accuracy. The external resistor  $R_{\text{SET}}$  is not a part of the regulator feedback loop and has therefore no impact on the output voltage accuracy. Ensure that there is no other leakage path than the  $R_{\text{SET}}$  resistor at the VSET pin during an undervoltage lockout event. Otherwise, a false output voltage is set.

表 8-1. Output Voltage Setting

VSET	Output Voltage Setting [V]			R <sub>SET</sub> [Ω]
	TPS628436	TPS628437	TPS628438	
1	0.400	0.80	1.8	10.0 k
2	0.425	0.85	1.9	12.1 k
3	0.450	0.90	2.0	15.4 k
4	0.475	0.95	2.1	18.7 k
5	0.500	1.00	2.2	23.7 k
6	0.525	1.05	2.3	28.7 k
7	0.550	1.10	2.4	36.5 k
8	0.575	1.15	2.5	44.2 k
9	0.600	1.20	2.6	56.2 k
10	0.625	1.25	2.7	68.1 k
11	0.650	1.30	2.8	86.6 k
12	0.675	1.35	2.9	105.0 k
13	0.700	1.40	3.0	133.0 k
14	0.725	1.45	3.1	162.0 k
15	0.750	1.50	3.2	205.0 k
16	0.775	1.55	3.3	249.0 k or larger
17	0.8	1.6	3.4	V <sub>IN</sub>
0	1.0	1.8	3.6	GND

### 8.3.4 Undervoltage Lockout (UVLO)

To avoid misoperation of the device at low input voltages, an undervoltage lockout (UVLO) comparator monitors the supply voltage. The UVLO comparator shuts down the device at an input voltage of 1.7 V (maximum) with falling V<sub>IN</sub>. The device starts at an input voltage of 1.8 V (maximum) rising V<sub>IN</sub>. After the device re-enters operation out of an undervoltage lockout condition, the device behaves like it does being enabled. The internal control logic is powered up and the external resistor at the VSET pin is read out.

### 8.3.5 Switch Current Limit, Short-Circuit Protection

The TPS62843 integrates a current limit on the high-side and low-side MOSFETs to protect the device against overload or short circuit conditions. The current in the switches is monitored cycle by cycle. If the high-side MOSFET current limit, I<sub>LIMF</sub> trips, the high-side MOSFET is turned off and the low-side MOSFET is turned on to ramp down the inductor current. After the inductor current through the low-side switch decreases beneath the low-side MOSFET current limit, I<sub>LIMF</sub>, the low-side MOSFET is turned off and the high-side MOSFET turns on again.

### 8.3.6 Thermal Shutdown

The junction temperature (T<sub>J</sub>) of the device is monitored by an internal temperature sensor. If T<sub>J</sub> exceeds the thermal shutdown temperature, T<sub>SD</sub>, of 160°C (typical), the device enters thermal shutdown. Both the high-side and low-side power FETs are turned off. When T<sub>J</sub> decreases below the hysteresis amount of typically 20°C, the converter resumes operation, beginning with a soft start to the originally set V<sub>OUT</sub> (there is no R2D conversion of R<sub>SET</sub>). The thermal shutdown is not active in power save mode.

### 8.3.7 Output Voltage Discharge

The purpose of the output discharge function is to ensure a defined down-ramp of the output voltage when the device is disabled and to keep the output voltage close to 0 V.

The internal discharge resistor is connected to the VOS pin. The discharge function is enabled as soon as the device is disabled. The minimum supply voltage required to keep the discharge function active is V<sub>IN</sub> > V<sub>TH\_UVLO</sub>.

## 8.4 Device Functional Modes

### 8.4.1 Power Save Mode Operation

The DCS-Control topology supports power save mode operation. At light loads, the device operates in PFM (pulse frequency modulation) mode that generates a single switching pulse to ramp up the inductor current and recharge the output capacitor, followed by a sleep period where most of the internal circuits are shut down to achieve the lowest operating quiescent current. During this time, the load current is supported by the output capacitor. The duration of the sleep period depends on the load current and the inductor peak current. During the sleep periods, the current consumption is reduced to typically 275 nA. This low quiescent current consumption is achieved by an ultra-low power voltage reference, an integrated high impedance feedback divider network, and an optimized power save mode operation.

In PFM mode, the switching frequency varies linearly with the load current. At medium and high load conditions, the device enters automatically PWM (pulse width modulation) mode and operates in continuous conduction mode with a nominal switch frequency  $f_{sw}$  of typically 1.5 MHz. The switching frequency in PWM mode is controlled and depends on  $V_{IN}$  and  $V_{OUT}$ . The boundary between PWM and PFM mode is when the inductor current becomes discontinuous.

If the load current decreases, the converter seamlessly enters PFM mode to maintain high efficiency down to very light loads. Because DCS-Control supports both operation modes within one single building block, the transition from PWM to PFM mode is seamless with minimum output voltage ripple.

### 8.4.2 100% Mode Operation

The duty cycle of the buck converter operating in PWM mode is given as  $D = V_{OUT}/V_{IN}$ . The duty cycle increases as the input voltage comes close to the output voltage. In 100% duty cycle mode, the device keeps the high-side switch on continuously. The high-side switch stays turned on as long as the output voltage is below the internal set point. This allows the conversion of small input to output voltage differences.

## 9 Application and Implementation

### 备注

以下应用部分中的信息不属于 TI 器件规格的范围，TI 不担保其准确性和完整性。TI 的客户应负责确定器件是否适用于其应用。客户应验证并测试其设计，以确保系统功能。

### 9.1 Application Information

The following sections discuss the design of the external components to complete the power supply design for several input and output voltage options by using typical applications as a reference.

### 9.2 Typical Application



图 9-1. TPS62843 Typical Application Circuit

#### 9.2.1 Design Requirements

表 9-1 shows the list of components for the application circuit and the characteristic application curves.

表 9-1. Components for Application Characteristic Curves

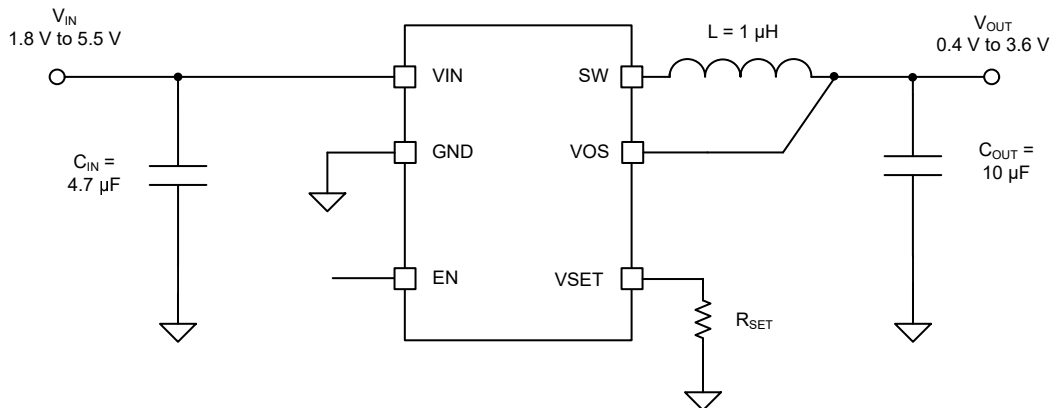
Reference	Description	Value	Size Code Inch [metric L × W × T]	Manufacturer
TPS628436, TPS628437, TPS628438	275 nA- $I_Q$ buck converter		[1.05 mm × 0.8 mm × 0.4 mm]	TI
$C_{IN}$	Ceramic capacitor GRM155R60J475ME47D	4.7 $\mu$ F	0402 [1.0 mm × 0.5 mm × 0.5 mm]	Murata
L	Inductor DFE201610-1R0M	1 $\mu$ H	0806 [2.0 mm × 1.6 mm × 1.0 mm]	Murata
$C_{OUT}$	Ceramic capacitor GRM155R60J106ME15D	10 $\mu$ F	0402 [1.0 mm × 0.5 mm × 0.5 mm]	Murata
$R_{SET}$	See voltage setting table		0402 [1.0 mm × 0.5 mm × 0.5 mm]	

#### 9.2.2 Detailed Design Procedure

Follow the passive component selection per the typical application circuit.

### 9.2.3 Application Curves



图 9-2. Efficiency at 0.4  $V_{OUT}$



图 9-3. Efficiency at 0.7  $V_{OUT}$

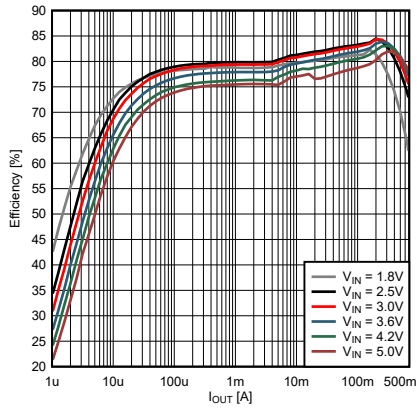

图 9-4. Efficiency at 1.2  $V_{OUT}$

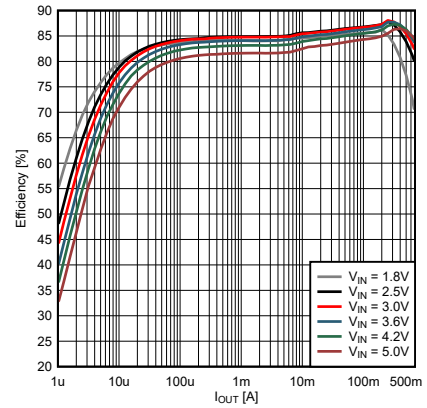

图 9-5. Efficiency at 1.8  $V_{OUT}$

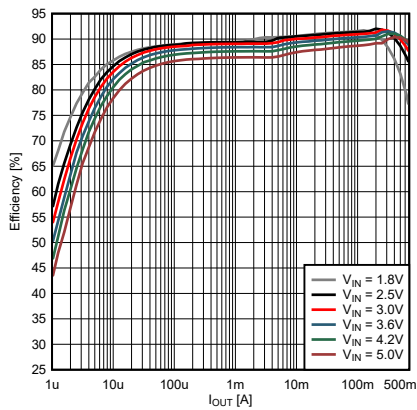

图 9-6. Efficiency at 3.3  $V_{OUT}$

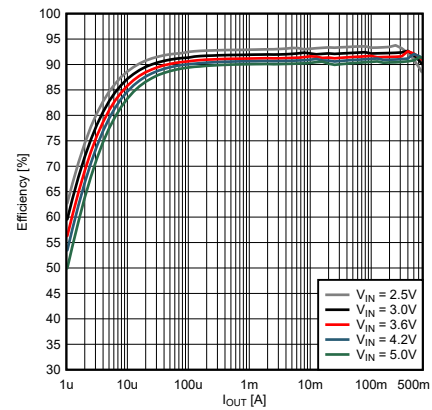

图 9-7. Output Voltage vs Output Current at 1.2  $V_{OUT}$

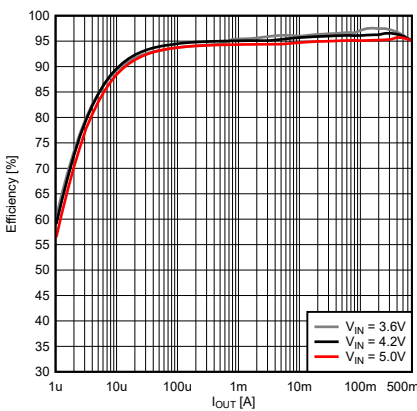

图 9-8. Output Voltage vs Output Current at 0.7  $V_{OUT}$

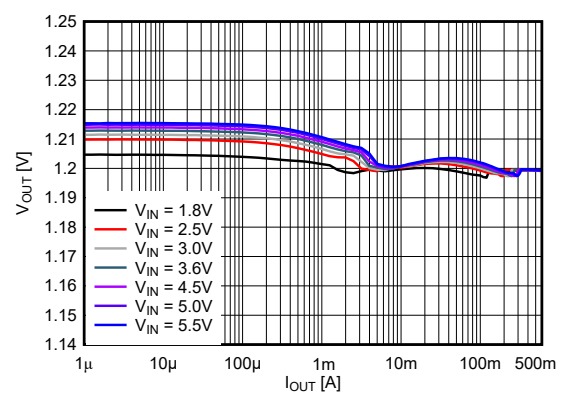

图 9-9. Switching Frequency vs Output Current at 0.4  $V_{OUT}$

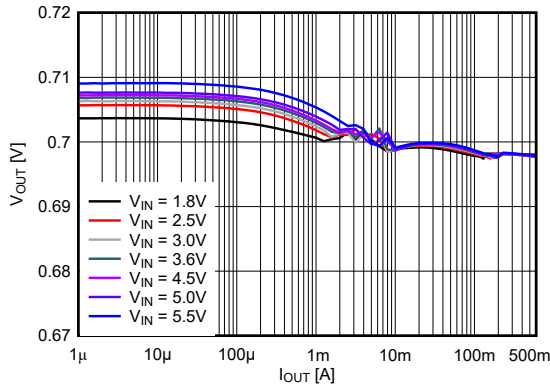

图 9-10. Switching Frequency vs Output Current at 0.7  $V_{OUT}$

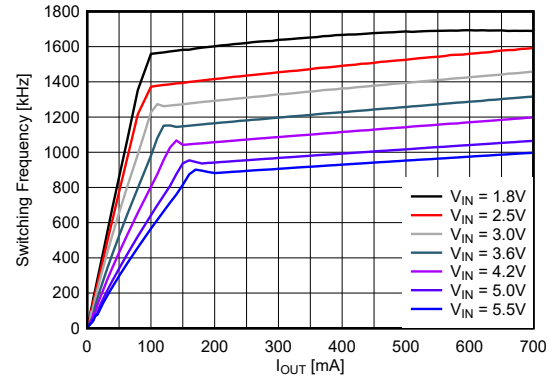

图 9-11. Switching Frequency vs Output Current at 1.2  $V_{OUT}$

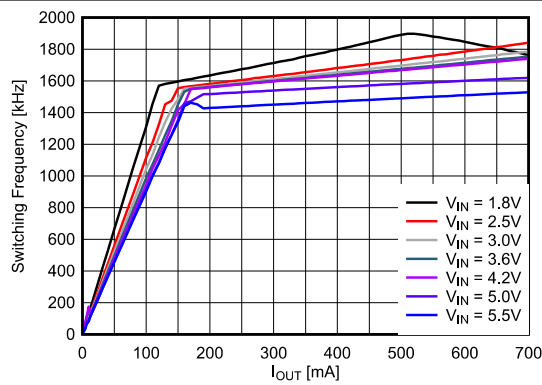

图 9-12. Switching Frequency vs Output Current at 1.8  $V_{OUT}$

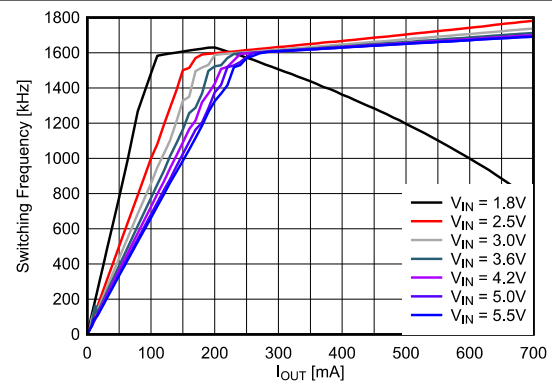

图 9-13. Typical Operation at 0.7  $V_{OUT}$ , 100  $\mu$ A  $I_{OUT}$

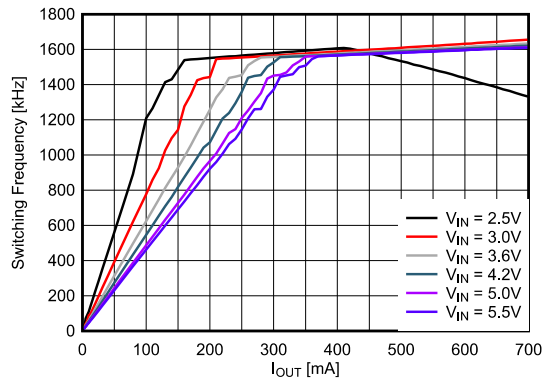

图 9-14. Typical Operation at 0.7 V<sub>OUT</sub>, 20 mA I<sub>OUT</sub>

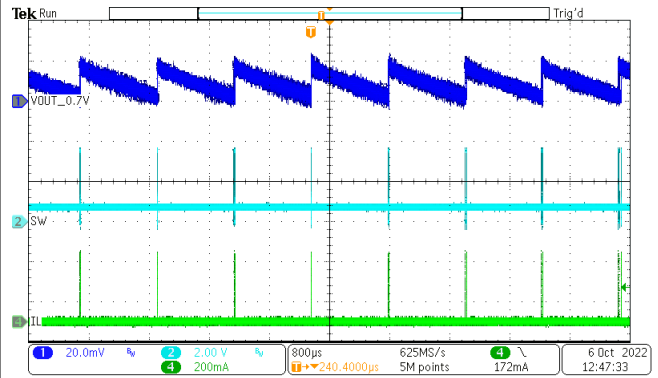

图 9-15. Typical Operation at 0.7 V<sub>OUT</sub>, 400 mA I<sub>OUT</sub>

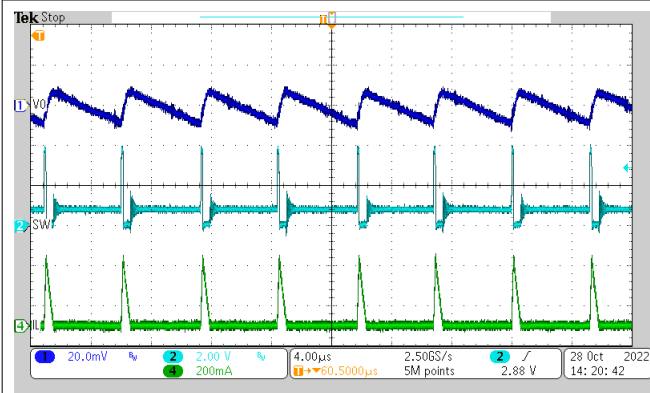

图 9-16. Load Transient at 0.7 V<sub>OUT</sub>, I<sub>OUT</sub> = 100 µA to 20 mA

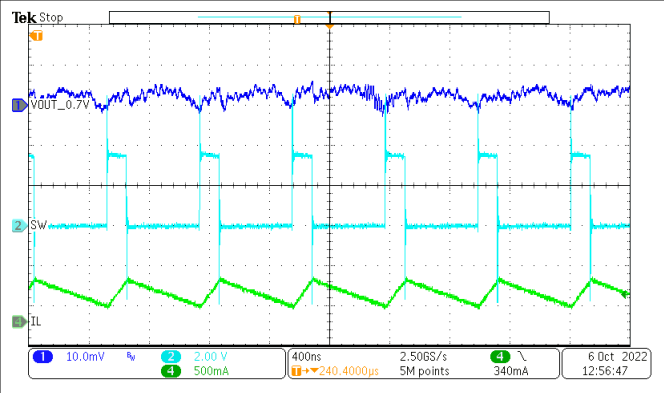

图 9-17. Load Transient at 0.7 V<sub>OUT</sub>, I<sub>OUT</sub> = 100 µA to 400 mA

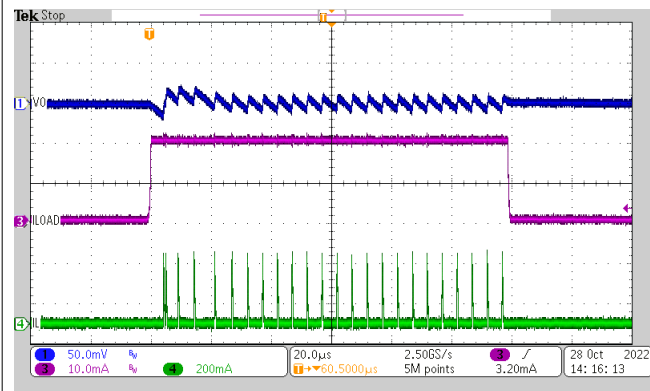

图 9-18. Load Transient at 0.7 V<sub>OUT</sub>, I<sub>OUT</sub> = 5 mA to 400 mA

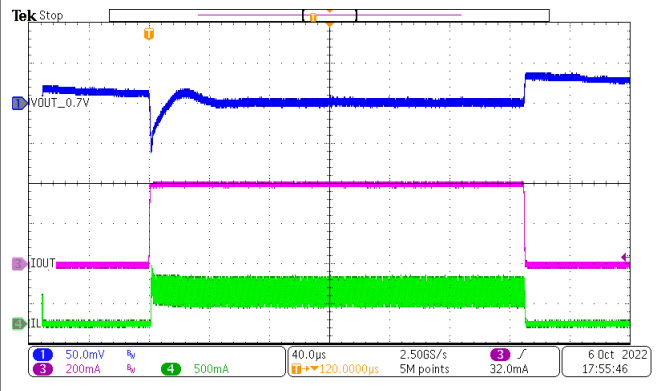

图 9-19. Load Transient at 1.2 V<sub>OUT</sub>, I<sub>OUT</sub> = 100 µA to 20 mA



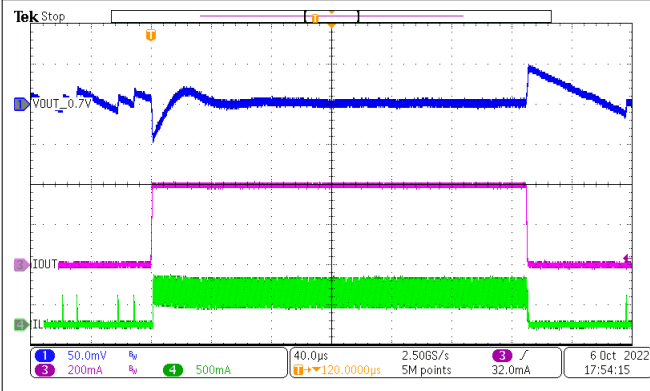

图 9-20. Load Transient at 1.2 V<sub>OUT</sub>, I<sub>OUT</sub> = 100 μA to 400 mA

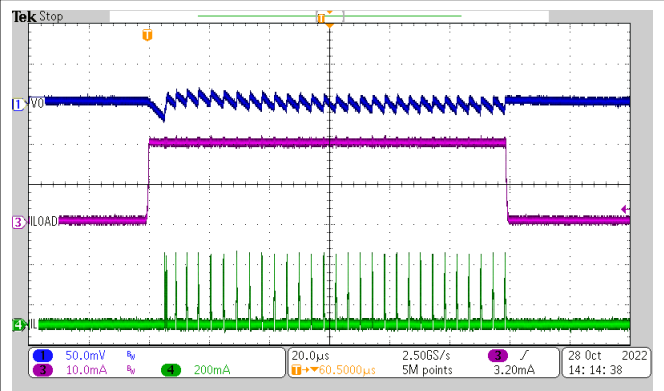

图 9-21. Load Transient at 1.2 V<sub>OUT</sub>, I<sub>OUT</sub> = 5 mA to 400 mA

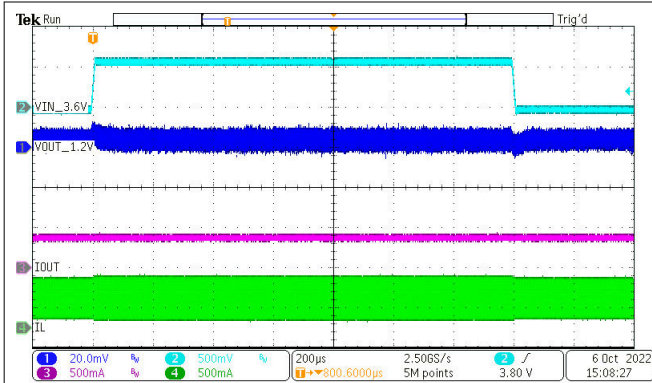

图 9-22. AC Load Sweep at 0.7 V<sub>OUT</sub>, I<sub>OUT</sub> = 1 mA to 600 mA

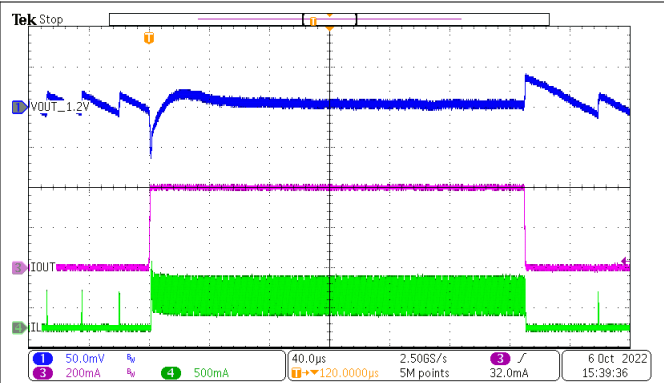

图 9-23. AC Load Sweep at 1.2 V<sub>OUT</sub>, I<sub>OUT</sub> = 1 mA to 600 mA

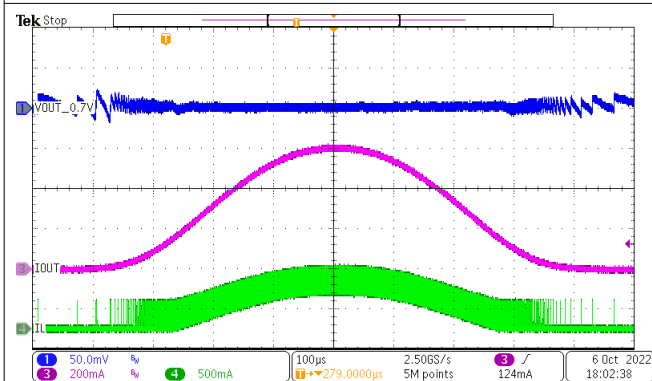

图 9-24. Line Transient at 0.7 V<sub>OUT</sub>, I<sub>OUT</sub> = 400 mA, V<sub>IN</sub> = 3.6 V to 4.2 V

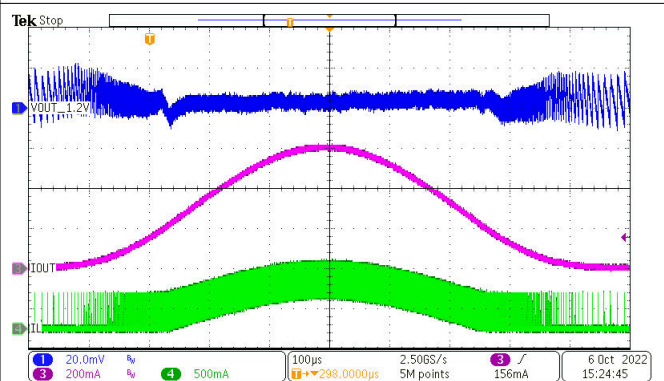

图 9-25. Line Transient at 1.2 V<sub>OUT</sub>, I<sub>OUT</sub> = 400 mA, V<sub>IN</sub> = 3.6 V to 4.2 V



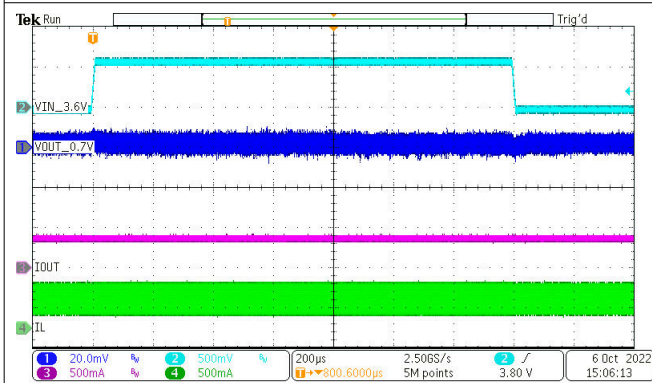

图 9-26. Shutdown, Output Discharge at 0.7 V<sub>OUT</sub>

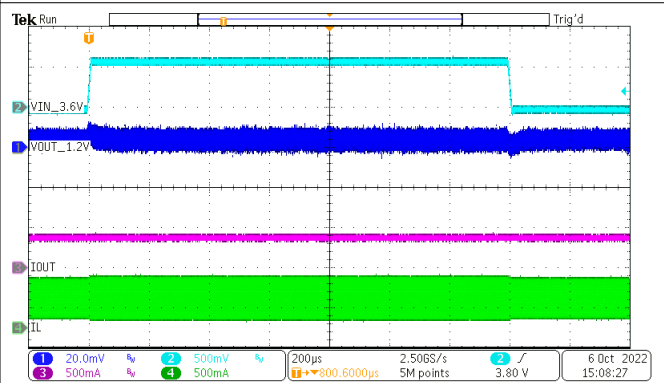

图 9-27. Start-Up Delay Time, VSET = GND

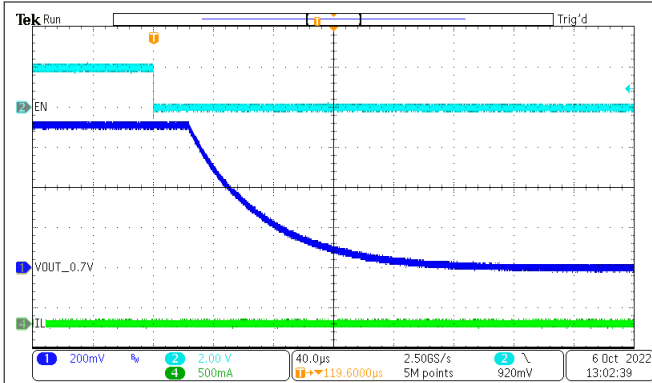

图 9-28. Start-Up Delay Time, VSET = 10 kohms

### 9.3 Power Supply Recommendations

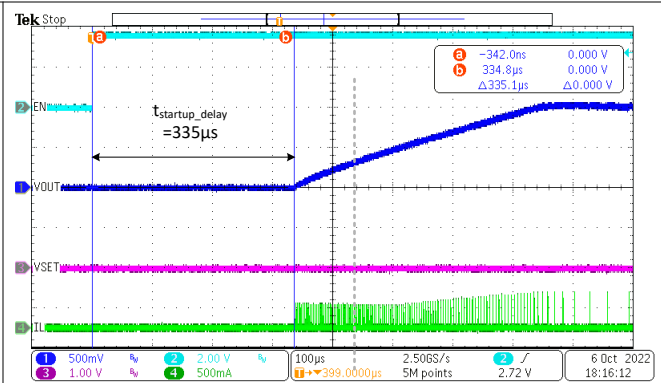
The power supply must provide a current rating according to the supply voltage, output voltage, and output current of the TPS62843.

### 9.4 Layout

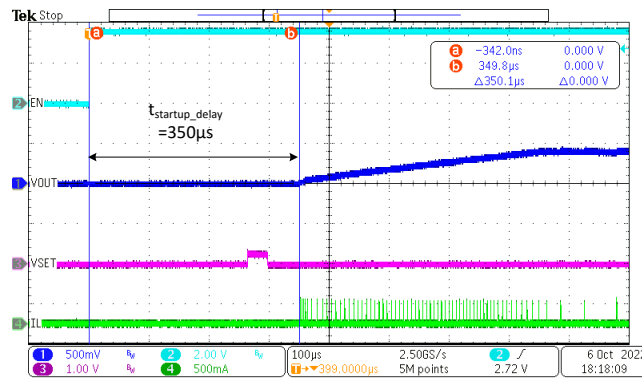
#### 9.4.1 Layout Guidelines

The pinout of TPS62843 has been optimized to enable a single top layer PCB routing of the IC and its critical passive components such as C<sub>IN</sub>, C<sub>OUT</sub>, and L. Furthermore, this pinout allows the user to connect tiny components such as 0201 (0603) size capacitors and 0402 (1005) size inductors. A solution size smaller than 5 mm<sup>2</sup> can be achieved with a fixed output voltage. As for all switching power supplies, the layout is an important step in the design. Care must be taken in board layout to get the specified performance. Providing a low inductance, low impedance ground path is critical. Therefore, use wide and short traces for the main current paths. Place the input capacitor as close as possible to the VIN of the IC and GND pins. This placement is the most critical component placement. The VOS line is a sensitive, high impedance line and must be connected to the output capacitor and routed away from noisy components and traces (for example, the SW line) or other noise sources.

### 9.4.2 Layout Example



图 9-29. Layout Example

## 10 Device and Documentation Support

TI offers an extensive line of development tools. Tools and software to evaluate the performance of the device, generate code, and develop solutions are listed below.

### 10.1 Device Support

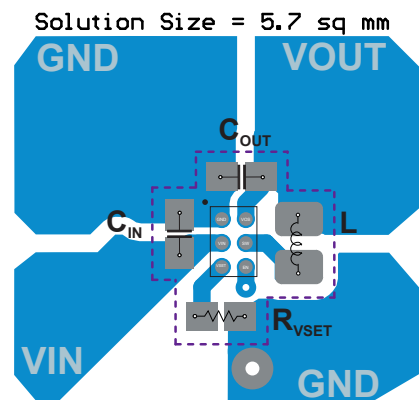
#### 10.1.1 第三方产品免责声明

TI 发布的与第三方产品或服务有关的信息，不能构成与此类产品或服务或保修的适用性有关的认可，不能构成此类产品或服务单独或与任何 TI 产品或服务一起的表示或认可。

### 10.2 接收文档更新通知

要接收文档更新通知，请导航至 [ti.com](http://ti.com) 上的器件产品文件夹。点击 [订阅更新](#) 进行注册，即可每周接收产品信息更改摘要。有关更改的详细信息，请查看任何已修订文档中包含的修订历史记录。

### 10.3 支持资源

[TI E2E™ 支持论坛](#) 是工程师的重要参考资料，可直接从专家获得快速、经过验证的解答和设计帮助。搜索现有解答或提出自己的问题可获得所需的快速设计帮助。

链接的内容由各个贡献者“按原样”提供。这些内容并不构成 TI 技术规范，并且不一定反映 TI 的观点；请参阅 TI 的《[使用条款](#)》。

### 10.4 Trademarks

TI E2E™ is a trademark of Texas Instruments.

所有商标均为其各自所有者的财产。

### 10.5 静电放电警告



静电放电 (ESD) 会损坏这个集成电路。德州仪器 (TI) 建议通过适当的预防措施处理所有集成电路。如果不遵守正确的处理和安装程序，可能会损坏集成电路。

ESD 的损坏小至导致微小的性能降级，大至整个器件故障。精密的集成电路可能更容易受到损坏，这是因为非常细微的参数更改都可能会导致器件与其发布的规格不相符。

### 10.6 术语表

[TI 术语表](#) 本术语表列出并解释了术语、首字母缩略词和定义。

## 11 Mechanical, Packaging, and Orderable Information

The following pages include mechanical, packaging, and orderable information. This information is the most current data available for the designated devices. This data is subject to change without notice and revision of this document. For browser-based versions of this data sheet, refer to the left-hand navigation.

**PACKAGING INFORMATION**

Orderable Device	Status (1)	Package Type	Package Drawing	Pins	Package Qty	Eco Plan (2)	Lead finish/ Ball material (6)	MSL Peak Temp (3)	Op Temp (°C)	Device Marking (4/5)	Samples
TPS628436YKAR	ACTIVE	DSBGA	YKA	6	12000	RoHS & Green	SNAGCU	Level-1-260C-UNLIM	-40 to 125	J	<a href="#">Samples</a>
TPS628437YKAR	ACTIVE	DSBGA	YKA	6	12000	RoHS & Green	SNAGCU	Level-1-260C-UNLIM	-40 to 125	K	<a href="#">Samples</a>
TPS628438YKAR	ACTIVE	DSBGA	YKA	6	12000	RoHS & Green	SNAGCU	Level-1-260C-UNLIM	-40 to 125	L	<a href="#">Samples</a>

(1) The marketing status values are defined as follows:

**ACTIVE:** Product device recommended for new designs.

**LIFEBUY:** TI has announced that the device will be discontinued, and a lifetime-buy period is in effect.

**NRND:** Not recommended for new designs. Device is in production to support existing customers, but TI does not recommend using this part in a new design.

**PREVIEW:** Device has been announced but is not in production. Samples may or may not be available.

**OBSOLETE:** TI has discontinued the production of the device.

(2) **RoHS:** TI defines "RoHS" to mean semiconductor products that are compliant with the current EU RoHS requirements for all 10 RoHS substances, including the requirement that RoHS substance do not exceed 0.1% by weight in homogeneous materials. Where designed to be soldered at high temperatures, "RoHS" products are suitable for use in specified lead-free processes. TI may reference these types of products as "Pb-Free".

**RoHS Exempt:** TI defines "RoHS Exempt" to mean products that contain lead but are compliant with EU RoHS pursuant to a specific EU RoHS exemption.

**Green:** TI defines "Green" to mean the content of Chlorine (Cl) and Bromine (Br) based flame retardants meet JS709B low halogen requirements of <=1000ppm threshold. Antimony trioxide based flame retardants must also meet the <=1000ppm threshold requirement.

(3) MSL, Peak Temp. - The Moisture Sensitivity Level rating according to the JEDEC industry standard classifications, and peak solder temperature.

(4) There may be additional marking, which relates to the logo, the lot trace code information, or the environmental category on the device.

(5) Multiple Device Markings will be inside parentheses. Only one Device Marking contained in parentheses and separated by a "~" will appear on a device. If a line is indented then it is a continuation of the previous line and the two combined represent the entire Device Marking for that device.

(6) Lead finish/Ball material - Orderable Devices may have multiple material finish options. Finish options are separated by a vertical ruled line. Lead finish/Ball material values may wrap to two lines if the finish value exceeds the maximum column width.

**Important Information and Disclaimer:**The information provided on this page represents TI's knowledge and belief as of the date that it is provided. TI bases its knowledge and belief on information provided by third parties, and makes no representation or warranty as to the accuracy of such information. Efforts are underway to better integrate information from third parties. TI has taken and continues to take reasonable steps to provide representative and accurate information but may not have conducted destructive testing or chemical analysis on incoming materials and chemicals. TI and TI suppliers consider certain information to be proprietary, and thus CAS numbers and other limited information may not be available for release.

In no event shall TI's liability arising out of such information exceed the total purchase price of the TI part(s) at issue in this document sold by TI to Customer on an annual basis.

YKA0006



# PACKAGE OUTLINE

DSBGA - 0.4 mm max height

DIE SIZE BALL GRID ARRAY

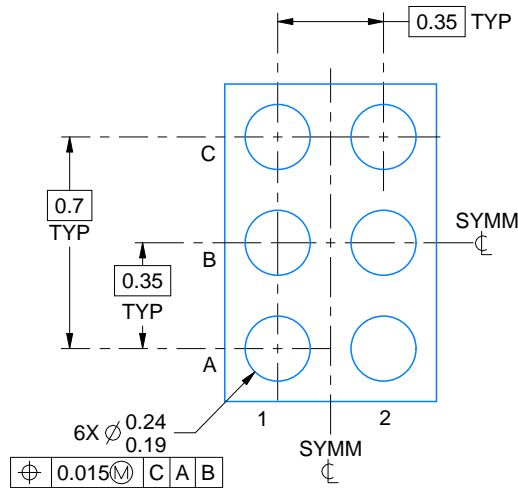
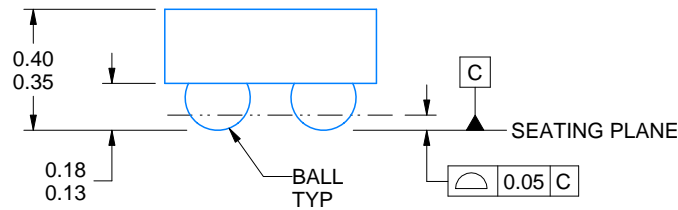
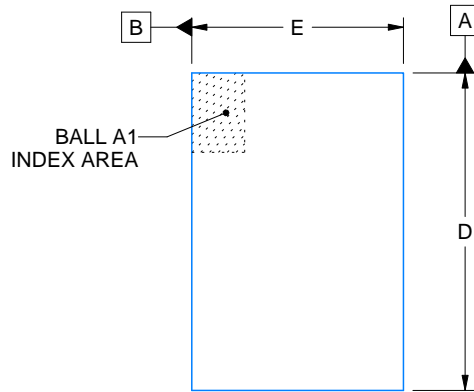

D: Max = 1.04 mm, Min = 0.98 mm  
E: Max = 0.787 mm, Min = 0.727 mm

4223607/B 06/2023

NOTES:

NanoFree is a trademark of Texas Instruments.

1. All linear dimensions are in millimeters. Any dimensions in parenthesis are for reference only. Dimensioning and tolerancing per ASME Y14.5M.
2. This drawing is subject to change without notice.
3. NanoFree™ package configuration.

# EXAMPLE BOARD LAYOUT

YKA0006

DSBGA - 0.4 mm max height

DIE SIZE BALL GRID ARRAY

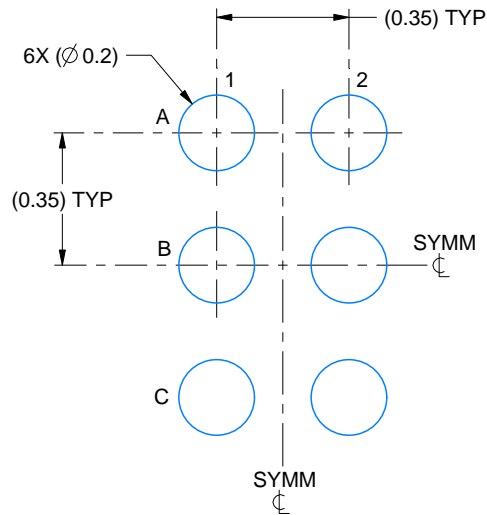

LAND PATTERN EXAMPLE  
EXPOSED METAL SHOWN  
SCALE:50X

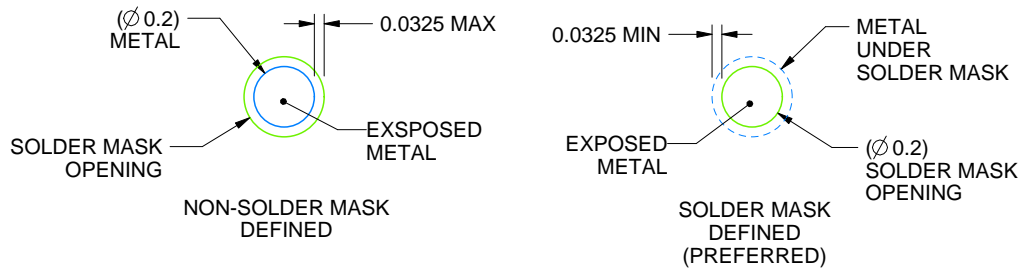

SOLDER MASK DETAILS  
NOT TO SCALE

4223607/B 06/2023

NOTES: (continued)

- 4. Final dimensions may vary due to manufacturing tolerance considerations and also routing constraints. For more information, see Texas Instruments literature number SNVA009 ([www.ti.com/lit/snva009](http://www.ti.com/lit/snva009)).



# EXAMPLE STENCIL DESIGN

YKA0006

DSBGA - 0.4 mm max height

DIE SIZE BALL GRID ARRAY

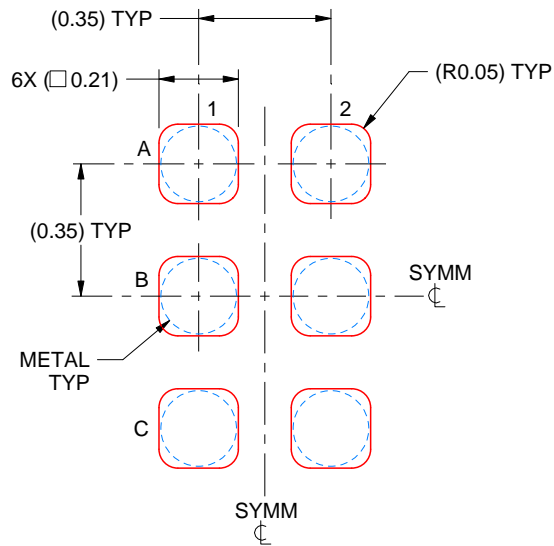

SOLDER PASTE EXAMPLE  
BASED ON 0.075 mm - 0.1 mm THICK STENCIL  
SCALE:50X

4223607/B 06/2023

NOTES: (continued)

5. Laser cutting apertures with trapezoidal walls and rounded corners may offer better paste release.

## 重要声明和免责声明

TI“按原样”提供技术和可靠性数据（包括数据表）、设计资源（包括参考设计）、应用或其他设计建议、网络工具、安全信息和其他资源，不保证没有瑕疵且不做任何明示或暗示的担保，包括但不限于对适销性、某特定用途方面的适用性或不侵犯任何第三方知识产权的暗示担保。

这些资源可供使用 TI 产品进行设计的熟练开发人员使用。您将自行承担以下全部责任：(1) 针对您的应用选择合适的 TI 产品，(2) 设计、验证并测试您的应用，(3) 确保您的应用满足相应标准以及任何其他功能安全、信息安全、监管或其他要求。

这些资源如有变更，恕不另行通知。TI 授权您仅可将这些资源用于研发本资源所述的 TI 产品的应用。严禁对这些资源进行其他复制或展示。您无权使用任何其他 TI 知识产权或任何第三方知识产权。您应全额赔偿因在这些资源的使用中对 TI 及其代表造成的任何索赔、损害、成本、损失和债务，TI 对此概不负责。

TI 提供的产品受 [TI 的销售条款](#) 或 [ti.com](#) 上其他适用条款/TI 产品随附的其他适用条款的约束。TI 提供这些资源并不会扩展或以其他方式更改 TI 针对 TI 产品发布的适用的担保或担保免责声明。

TI 反对并拒绝您可能提出的任何其他或不同的条款。

邮寄地址：Texas Instruments, Post Office Box 655303, Dallas, Texas 75265

Copyright © 2023，德州仪器 (TI) 公司