

版次	变更摘要	日期
0		

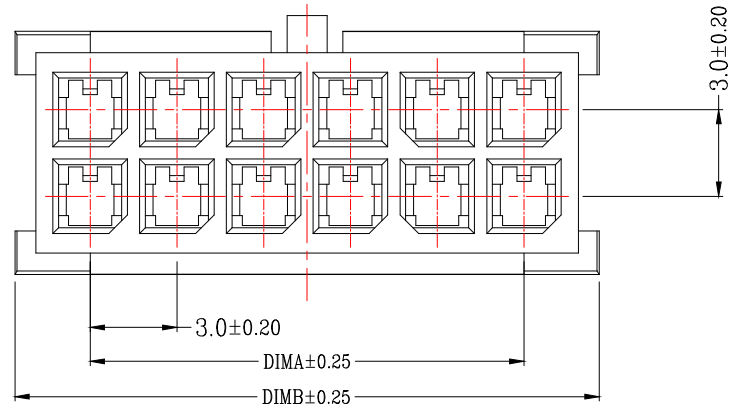

技术指标:

1. 温度范围:  $-25^{\circ}\text{C} \sim 85^{\circ}\text{C}$ .
2. 额定电压: 250V AC, DC.
3. 耐压: 1500V AC/minute.
4. 接触电阻:  $\leq 20\text{m}\Omega$ .
5. 绝缘电阻:  $\geq 1000\text{M}\Omega$ .
6. 额定电流: 5A AC, DC.

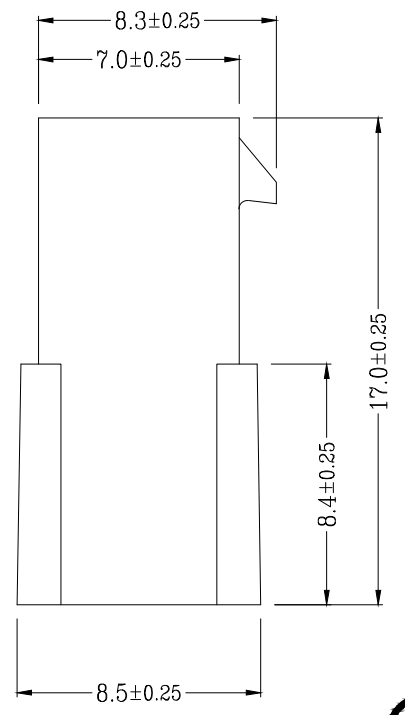
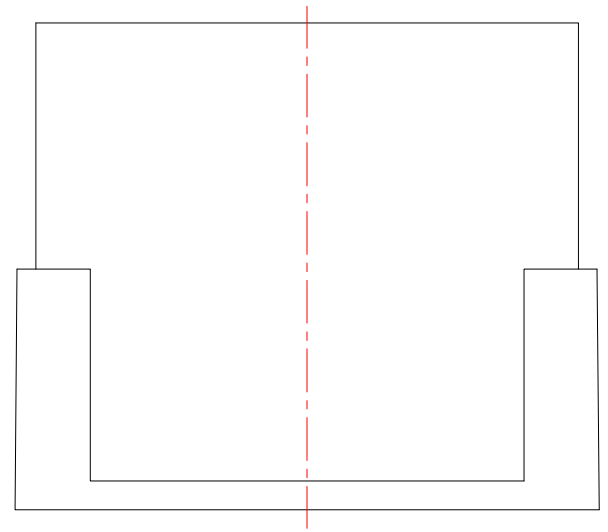
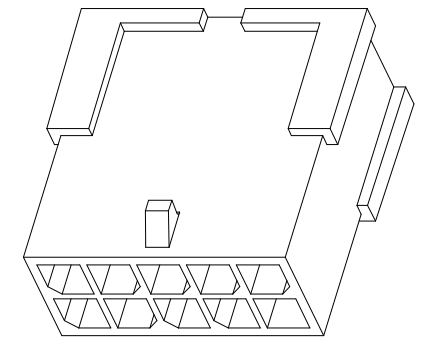

CKT	A	B
2*1		5.30
2*2	3.00	8.30
2*3	6.00	11.30
2*4	9.00	14.30
2*5	12.00	17.30
2*6	15.00	20.30
2*7	18.00	23.30
2*8	21.00	26.30
2*9	24.00	29.30
2*10	27.00	32.30
2*11	30.00	35.30
2*12	33.00	38.30



一般公差 (TOLERANCE)  
 X: ±.50    XX ±1.0  
 .X ±.20    .XXX ±.05  
 ANGLES    ±1°

兆星精密电子 (深圳) 有限公司

品名 (TITLE)	MX3.0-1双排母座胶壳	制图 (DR)	
料号 (DWG.NO)	ZX-MX3.0-2-3P-HMJK	校对 (CHKD)	
比例 (SCALE)	1:1	审核 (APPD)	
单位 (UNITS)	mm	张数 (SHEET)	1 OF 1
		SIZE	A4
		REV	A