

版次	变更摘要	日期
0		

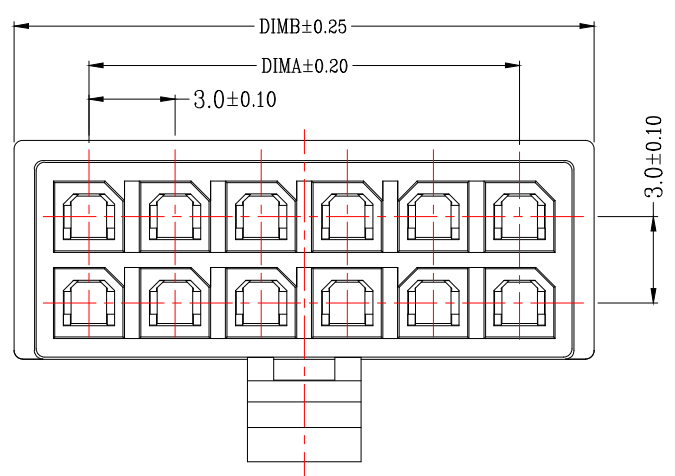
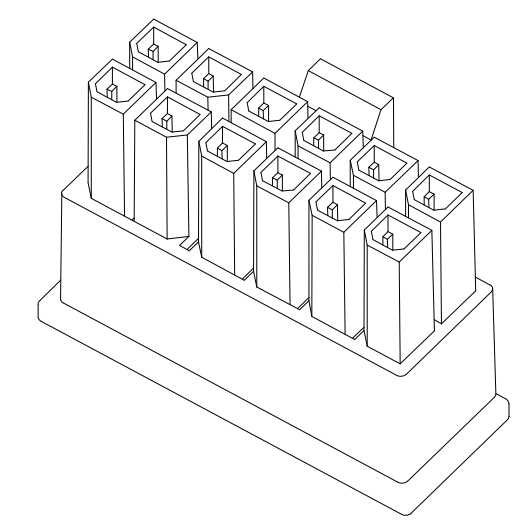
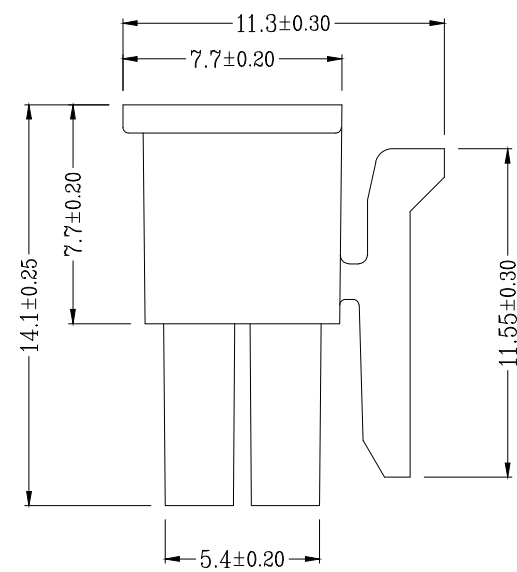
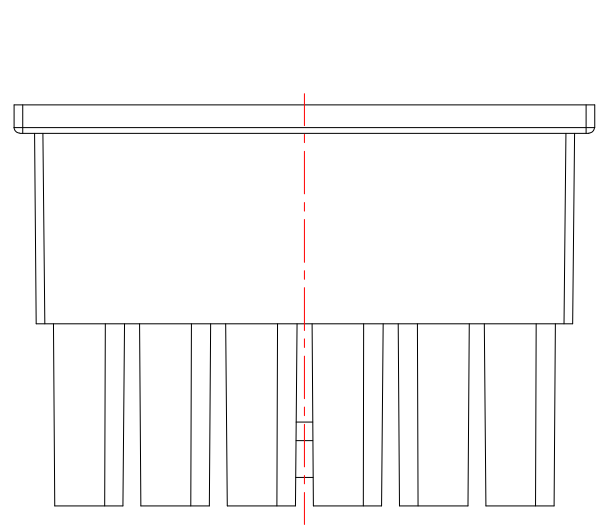

技术指标:

1. 温度范围:  $-25^{\circ}\text{C} \sim 85^{\circ}\text{C}$ .
2. 额定电压: 250V AC, DC.
3. 耐电压: 1500V AC/minute.
4. 接触电阻:  $\leq 20\text{m}\Omega$ .
5. 绝缘电阻:  $\geq 1000\text{M}\Omega$ .
6. 额定电流: 5A AC, DC.

CKT	A	B
2*1		5.20
2*2	3.00	8.20
2*3	6.00	11.20
2*4	9.00	14.20
2*5	12.00	17.20
2*6	15.00	20.20
2*7	18.00	23.20
2*8	21.00	26.20
2*9	24.00	29.20
2*10	27.00	32.20
2*11	30.00	35.20
2*12	33.00	38.20



兆星精密电子 (深圳) 有限公司

品名 (TITLE)	MX3.0双排公头胶壳		制图 (DR)
料号 (DWG.NO)	ZX-MX3.0-2-3P-HGJK		校对 (CHKD)
比例 (SCALE)	1:1	单位 (UNITS)	mm
张数 (SHEET)	1 OF 1	尺寸 (SIZE)	A4
审核 (APPD)		REV	A

一般公差 (TOLERANCE)
X: ±.50    .XX ±.10
.X ±.20    .XXX ±.05
ANGLES    ±1°