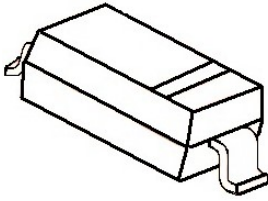

SOD-323

SOD-323 贴片塑封稳压二极管
SOD-323 Plastic-Encapsulate Zener Diode
特征 Features

- 齐纳击穿阻抗低; Low Zener Impedance
- 最大功率耗散 200mW; Power Dissipation of 200mW
- 高稳定性和可靠性。High Stability and High Reliability

机械数据 Mechanical Data

- 封装: SOD-323 封装 SOD-323 Small Outline Plastic Package
- 极性: 色环端为负极 Polarity: Color band denotes cathode end
- 安装位置: 任意 Mounting Position: Any

极限值和温度特性(TA = 25°C 除非另有规定)

Maximum Ratings & Thermal Characteristics (Ratings at 25°C ambient temperature unless otherwise specified.)

参数 Parameters	符号 Symbol	数值 Value	单位 Unit
功率消耗 Power Dissipation	Pd	200 ¹⁾	mW
正向压降 Forward Voltage @IF=10mA	Vf	0.9 ²⁾	V
存储温度 Storage temperature range	Ts	-65-+150	°C

1) Device mounted on ceramic PCB: 7.6mm x 9.4mm x 0.87mm with pad areas 25mm²

2) Short duration test pulse used to minimize self-heating effect

3) f=1KHz

电特性 (TA = 25°C 除非另有规定)

Electrical Characteristics (Ratings at 25°C ambient temperature unless otherwise specified).

Device	Marking	Zener Voltage Range				Maximum Zener Impedance ³⁾			Maximum Reverse Current		Typical Temperature coefficient @ IZTC=mV/°C		Test Current IZTC
		Vz@Izt			Izt	Zzt @Izt	Zzk @Izk	Izk	IR	VR	Min	Max	
		Nom(V)	Min(V)	Max(V)	mA	Ω		mA	uA	V			
BZT52C2V0S	WY	2.0	1.80	2.15	5	150	600	1.0	100	1.0	-3.5	0	5
BZT52C2V4S	WX	2.4	2.2	2.6	5	100	600	1.0	50	1.0	-3.5	0	5
BZT52C2V7S	W1	2.7	2.5	2.9	5	100	600	1.0	20	1.0	-3.5	0	5
BZT52C3V0S	W2	3.0	2.8	3.2	5	95	600	1.0	10	1.0	-3.5	0	5
BZT52C3V3S	W3	3.3	3.1	3.5	5	95	600	1.0	5	1.0	-3.5	0	5
BZT52C3V6S	W4	3.6	3.4	3.8	5	90	600	1.0	5	1.0	-3.5	0	5
BZT52C3V9S	W5	3.9	3.7	4.1	5	90	600	1.0	3	1.0	-3.5	0	5
BZT52C4V3S	W6	4.3	4.0	4.6	5	90	600	1.0	3	1.0	-3.5	0	5
BZT52C4V7S	W7	4.7	4.4	5.0	5	80	500	1.0	3	2.0	-3.5	0.2	5
BZT52C5V1S	W8	5.1	4.8	5.4	5	60	480	1.0	2	2.0	-2.7	1.2	5
BZT52C5V6S	W9	5.6	5.2	6.0	5	40	400	1.0	1	2.0	-2.0	2.5	5
BZT52C6V2S	WA	6.2	5.8	6.6	5	10	150	1.0	3	4.0	0.4	3.7	5
BZT52C6V8S	WB	6.8	6.4	7.2	5	15	80	1.0	2	4.0	1.2	4.5	5
BZT52C7V5S	WC	7.5	7.0	7.9	5	15	80	1.0	1	5.0	2.5	5.3	5
BZT52C8V2S	WD	8.2	7.7	8.7	5	15	80	1.0	0.7	5.0	3.2	6.2	5
BZT52C9V1S	WE	9.1	8.5	9.6	5	15	100	1.0	0.5	6.0	3.8	7.0	5
BZT52C10S	WF	10	9.4	10.6	5	20	150	1.0	0.2	7.0	4.5	8.0	5
BZT52C11S	WG	11	10.4	11.6	5	20	150	1.0	0.1	8.0	5.4	9.0	5
BZT52C12S	WH	12	11.4	12.7	5	25	150	1.0	0.1	8.0	6.0	10.0	5
BZT52C13S	WI	13	12.4	14.1	5	30	170	1.0	0.1	8.0	7.0	11.0	5

Device	Marking	Zener Voltage Range				Maximum Zener Impedance			Maximum Reverse Current		Typical Temperature coefficient @ IZTC=mV/°C		Test Current IZTC
		Vz@Izt			Izt	Zzt @Izt	Zzk @Izk	Izk	IR	VR	Min	Max	
		Nom(V)	Min(V)	Max(V)	mA	Ω	Ω	mA	uA	V			
BZT52C15S	WJ	15	13.8	15.6	5	30	200	1.0	0.1	10.5	9.2	13.0	5
BZT52C16S	WK	16	15.3	17.1	5	40	200	1.0	0.1	11.2	10.4	14.0	5
BZT52C18S	WL	18	16.8	19.1	5	45	225	1.0	0.1	12.6	12.4	16.0	5
BZT52C20S	WM	20	18.8	21.2	5	55	225	1.0	0.1	14.0	14.4	18.0	5
BZT52C22S	WN	22	20.8	23.3	5	55	250	1.0	0.1	15.4	16.4	20.0	5
BZT52C24S	WO	24	22.8	25.6	5	70	250	1.0	0.1	16.8	18.4	22.0	5
BZT52C27S	WP	27	25.1	28.9	2	80	300	0.5	0.1	18.9	21.4	25.3	2
BZT52C30S	WQ	30	28.0	32.0	2	80	300	0.5	0.1	21.0	24.4	29.4	2
BZT52C33S	WR	33	31.0	35.0	2	80	325	0.5	0.1	23.1	27.4	33.4	2
BZT52C36S	WS	36	34.0	38.0	2	90	350	0.5	0.1	25.2	30.4	37.4	2
BZT52C39S	WT	39	37.0	41.0	2	130	350	0.5	0.1	27.3	33.4	41.2	2
BZT52C43S	WU	43	40.0	46.0	2	100	700	1.0	0.1	32.0	10.0	12.0	5
BZT52C47S	WV	47	44.0	50.0	2	100	750	1.0	0.1	35.0	10.0	12.0	5
BZT52C51S	WW	51	48.0	54.0	2	100	750	1.0	0.1	38.0	10.0	12.0	5
BZT52C56S	XW	56	52.0	60.0	2	135	700	1.0	0.1	39.0	10.0	12.0	5
BZT52C62S	6E	62	58.0	66.0	2	200	1000	1.0	0.2	47.0	10.0	12.0	5
BZT52C68S	6F	68	64.0	72.0	2	250	1000	1.0	0.2	52.0	10.0	12.0	5
BZT52C75S	6H	75	70.0	79.0	2	300	1000	1.0	0.2	57	10.0	12.0	5

Breakdown characteristics
at Tj=constant (pulsed)

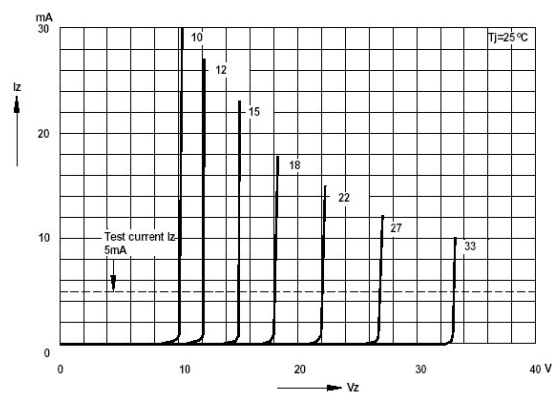
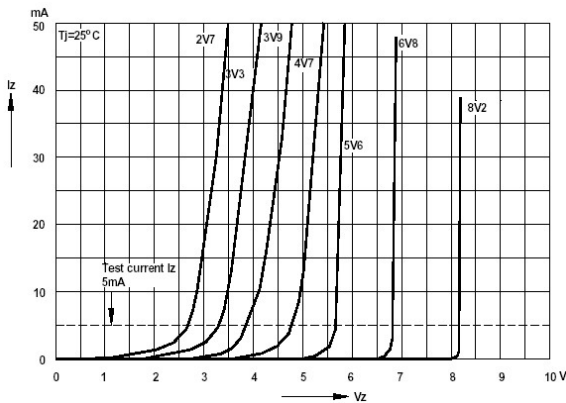

Forward characteristics

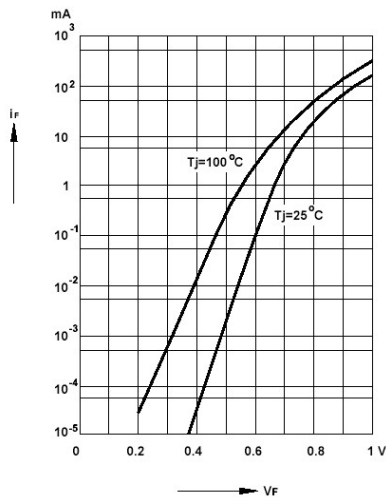

Admissible power dissipation versus ambient temperature

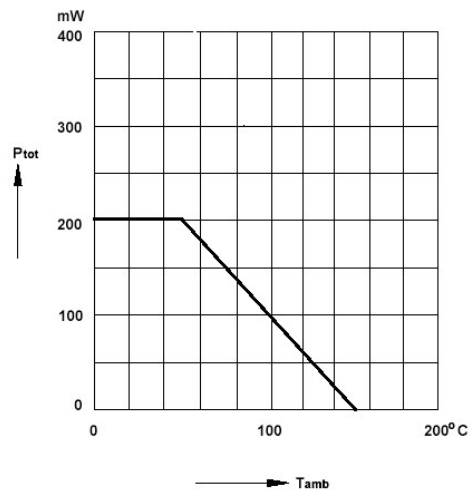



Pulse thermal resistance versus pulse duration

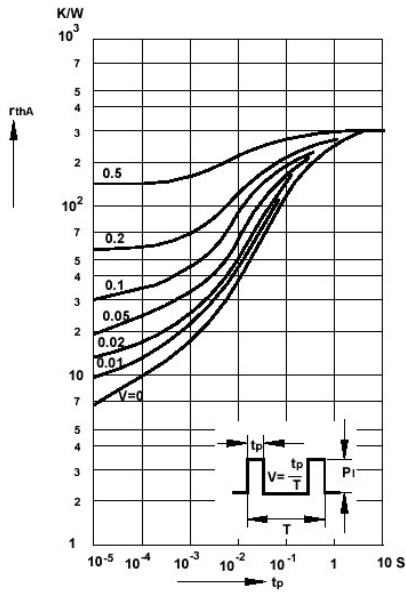

Dynamic resistance versus Zener current

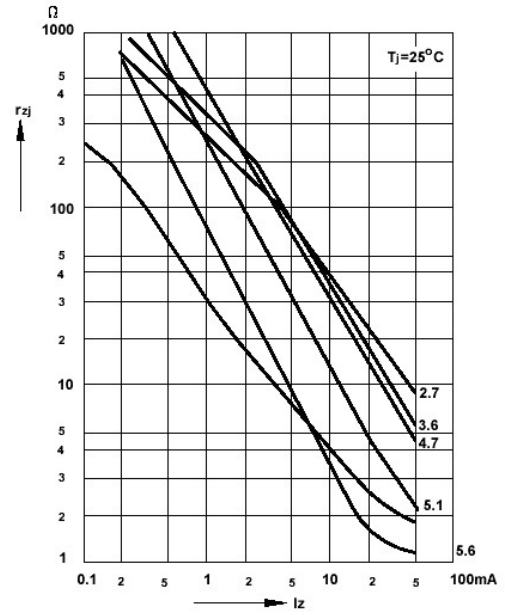

Capacitance versus Zener voltage

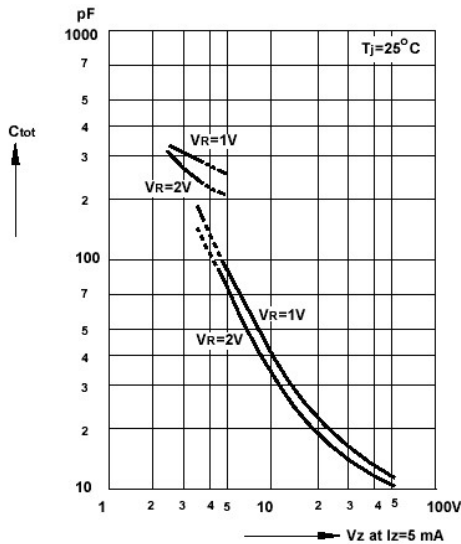

Dynamic resistance versus Zener current

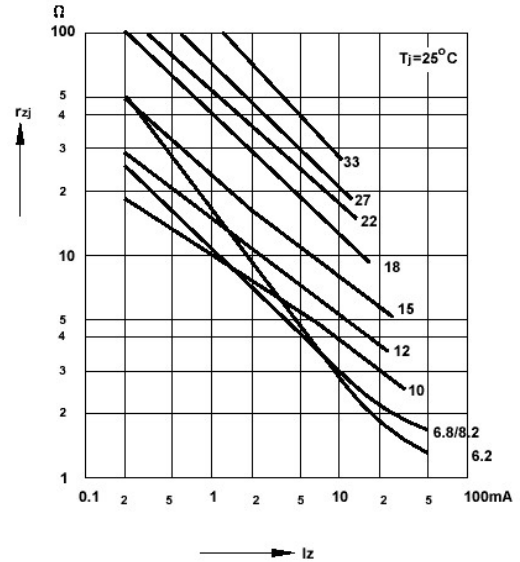

Dynamic resistance versus Zener current

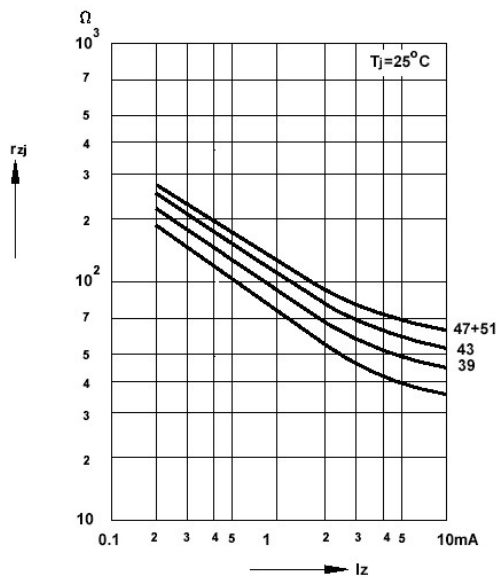

Thermal differential resistance versus Zener voltage

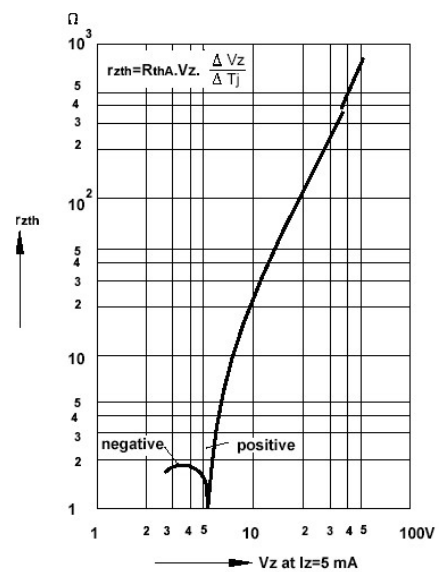



Dynamic resistance versus Zener voltage

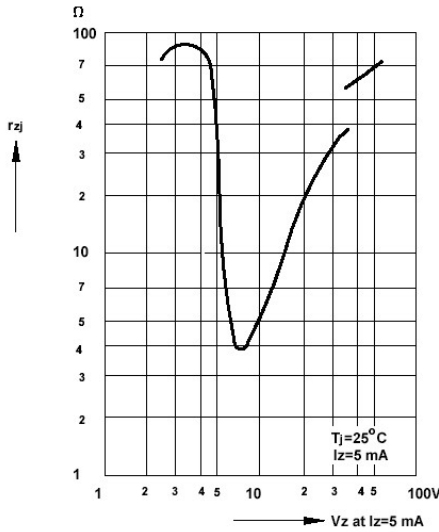

Temperature dependence of Zener voltage versus Zener voltage

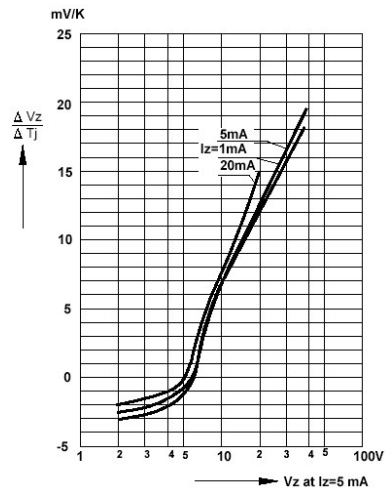

Temperature dependence of Zener voltage versus Zener voltage

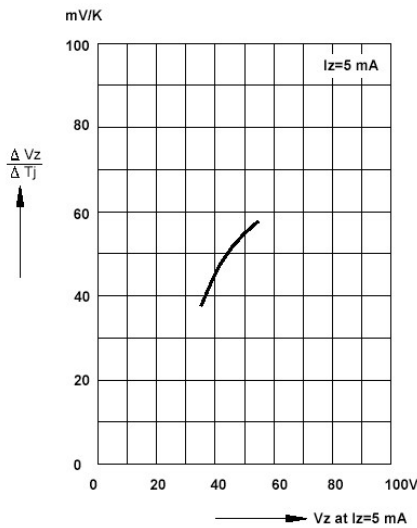

Change of Zener voltage versus junction temperature

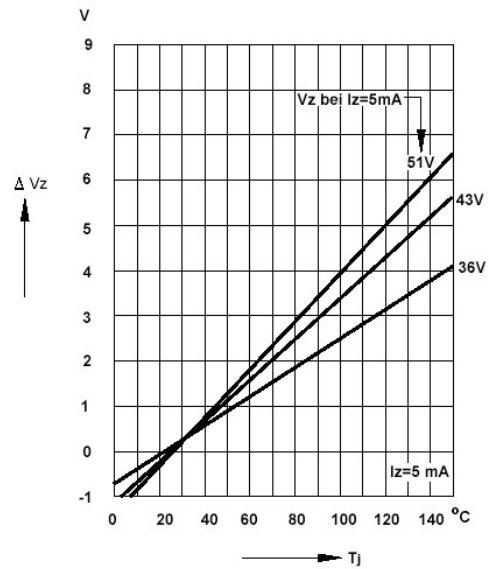

Change of Zener voltage versus junction temperature

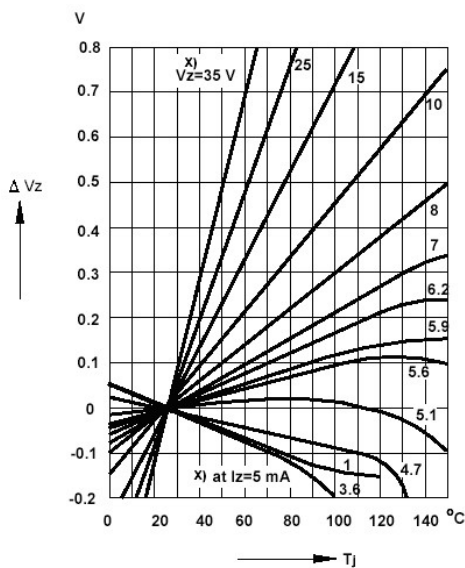

Change of Zener voltage from turn-on up to the point of thermal equilibrium versus Zener voltage

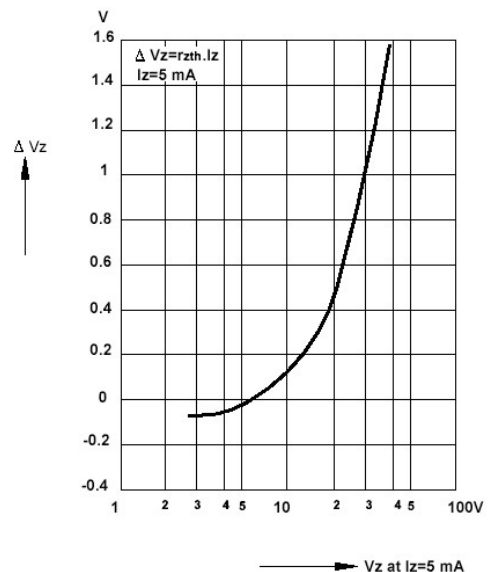



SOD-323 PACKAGE OUTLINE Plastic surface mounted package

SOD-323

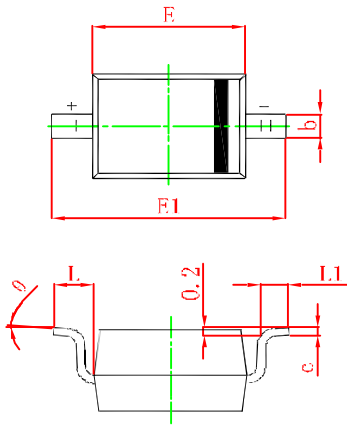

Symbol	Min.(mm)	Max.(mm)
A		1.000
A1	0.000	0.100
A2	0.800	0.900
b	0.250	0.350
c	0.080	0.150
D	1.200	1.400
E	1.600	1.800
E1	2.500	2.700
L	0.475REF	
L1	0.250	0.400
θ	0°	8°