

### SOD-323 Plastic-Encapsulate ESD Protection Diodes

#### DESCRIPTION

ESD3Z5V0BU is an ultra low-capacitance Transient Voltage Suppressor (TVS) designed to provide electrostatic discharge (ESD) protection for high-speed data interfaces. With typical capacitance of 0.25pF, ESD3Z5V0BU is designed to protect parasitic-sensitive systems against over-voltage and over-current transient events. It complies with IEC 61000-4-2 (ESD), Level 4 ( $\pm 15\text{kV}$  air,  $\pm 8\text{kV}$  contact discharge), IEC 61000-4-4 (electrical fast transient - EFT) (40A, 5/50 ns), very fast charged device model (CDM) ESD and cable discharge event (CDE), etc.

ESD3Z5V0BU uses ultra-small SOD-323 package. Each ESD3Z5V0BU device can protect one high-speed data line. It offers system designers flexibility to protect single data line where space is a premium concern. The combined features of low capacitance, ultra-small size and high ESD robustness make ESD3Z5V0BU ideal for high-speed data port and high-frequency line applications, such as cellular phones and HD visual devices.

#### Features

- ◆ Peak power dissipation: 100W (8/20 $\mu\text{s}$ )
- ◆ Transient protection for high-speed data lines
- ◆ IEC61000-4-2 (ESD)  $\pm 15\text{kV}$  (air),  $\pm 8\text{kV}$  (contact)
- ◆ IEC61000-4-4 (EFT) 40A (5/50ns)  
Cable Discharge Event (CDE)
- ◆ Ultra-small package
- ◆ Protects one data, control line
- ◆ Low capacitance: 0.25pF (Typical)
- ◆ Low clamping voltage
- ◆ Low leakage current
- ◆ Meets MSL 1 Requirements

#### Pin Configuration



#### Circuit Diagram

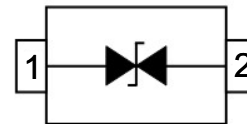

#### Mechanical Characteristics

- ◆ Package: SOD-323
- ◆ Flammability Rating: UL 94V-0
- ◆ High temperature soldering guaranteed:  
260 $^{\circ}\text{C}$ / 10s
- ◆ Packaging: Tape and Reel
- ◆ Marking: 5BU

#### Absolute Maximum Ratings ( $T_A=25^{\circ}\text{C}$ unless otherwise specified)

Parameter	Symbol	Value	Unit
ESD per IEC 61000-4-2 (Air)	VESD	$\pm 20$	KV
ESD per IEC 61000-4-2 (Contact)		$\pm 20$	
Peak Pulse Power(8/20us )	PPP	100	W
Operating Temperature	T <sub>OPT</sub>	-55 to +125	$^{\circ}\text{C}$
Storage Temperature	T <sub>STG</sub>	-55 to +150	$^{\circ}\text{C}$
Lead Solder Temperature – Maximum (10 Second Duration)	T <sub>L</sub>	260(10 sec.)	$^{\circ}\text{C}$

The above data are for reference only.

DN:T20427A0

**Electrical Characteristics** ( $T_A=25^{\circ}\text{C}$  unless otherwise specified)

Symbol	Parameter	Test Condition	Min	Typ	Max	Units
$V_{RWM}$	Reverse Working Voltage				5.0	V
$V_{BR}$	Reverse Breakdown Voltage	$I_T = 1\text{mA}$	6.0			V
$I_R$	Reverse Leakage Current	$V_{RWM} = 5.0\text{V}$			100	nA
$V_C$	Clamping Voltage	$I_{PP} = 1\text{A}, t_p = 8/20\mu\text{s}$			13	V
$V_C$	Clamping Voltage	$I_{PP} = 4\text{A}, t_p = 8/20\mu\text{s}$			25	V
$C_J$	Junction Capacitance	$V_R = 0\text{V}, f = 1\text{MHz}$		0.25	0.40	pF

The above data are for reference only.



### ELECTRICAL CHARACTERISTICS CURVE

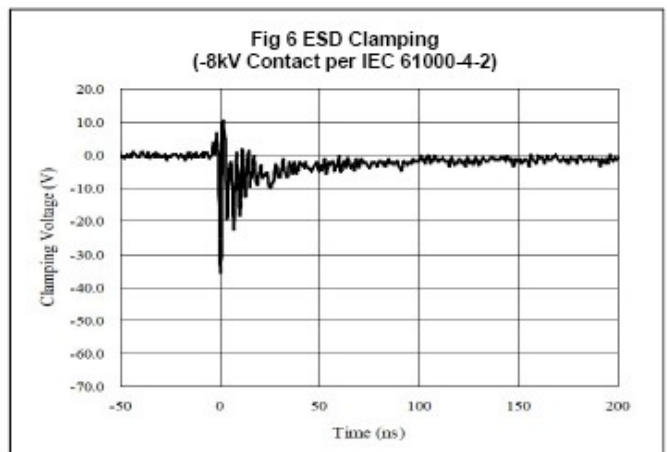
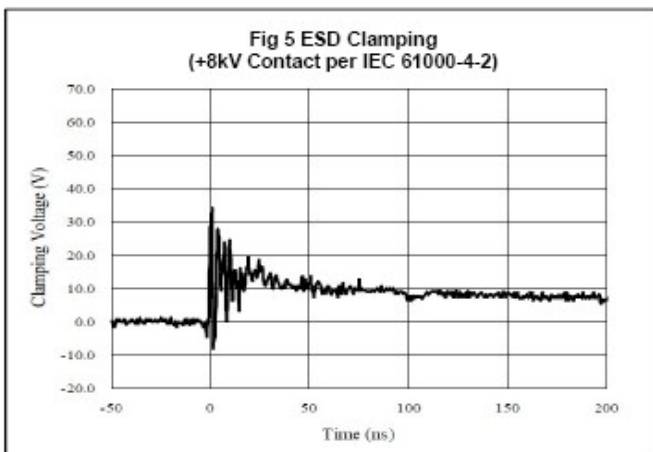
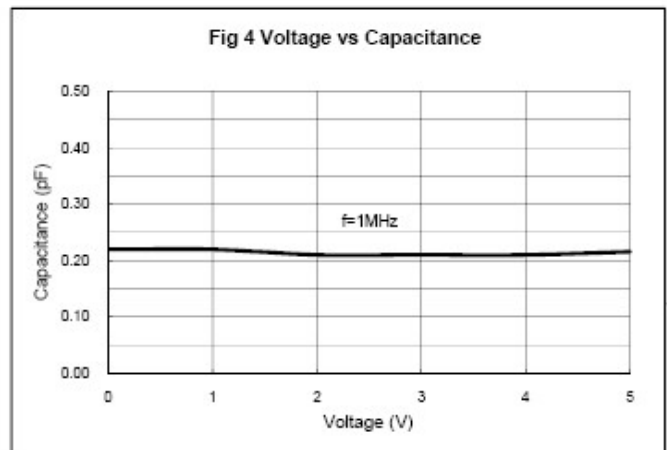
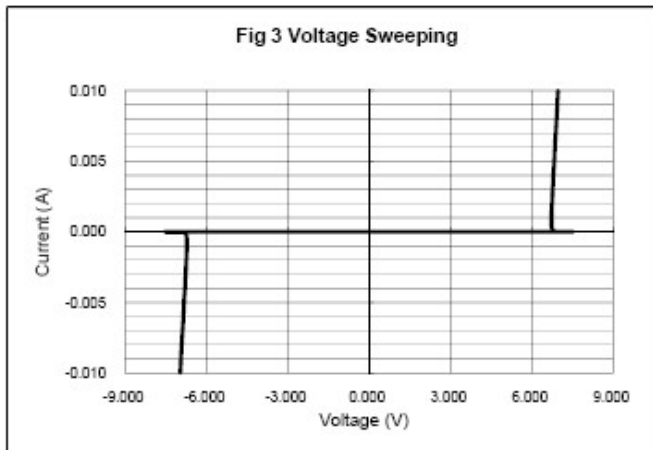
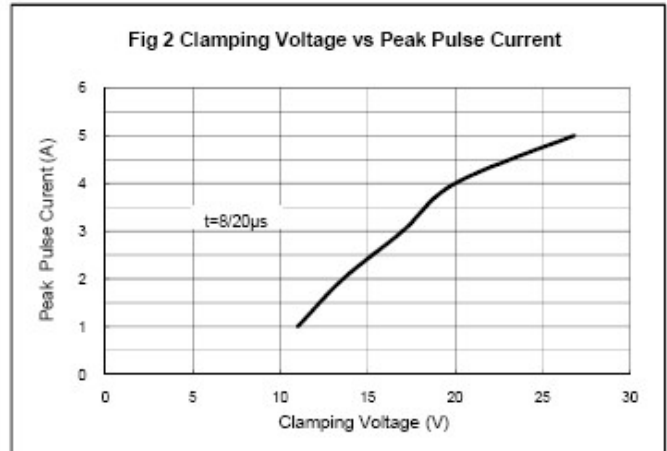
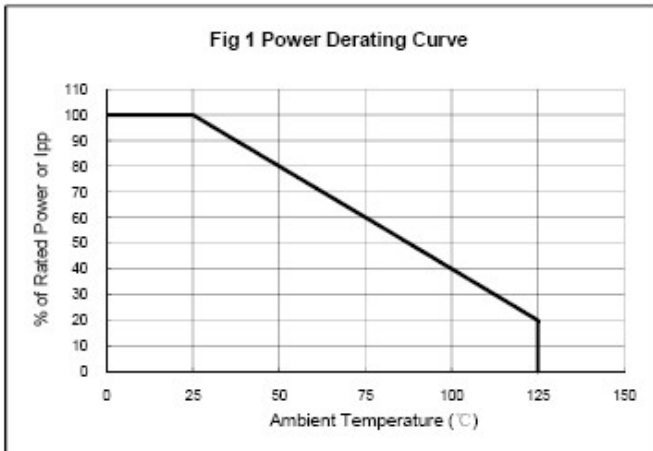

The curve above is for reference only.

### Outline Drawing

#### SOD-323 Package Outline Dimensions

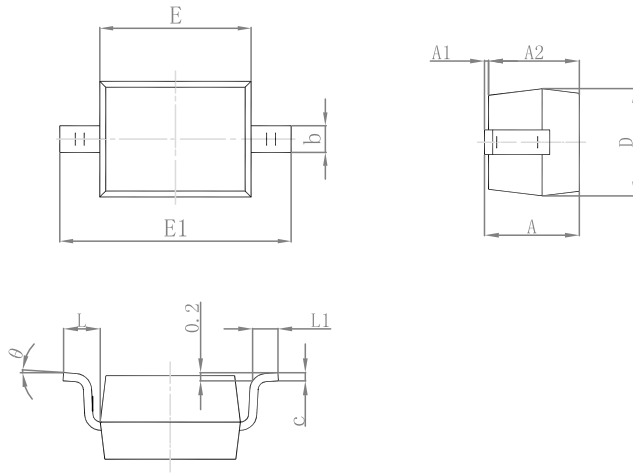

Symbol	Dimensions In Millimeters		Dimensions In Inches	
	Min.	Max.	Min.	Max.
A		1.000		0.039
A1	0.000	0.100	0.000	0.004
A2	0.800	0.900	0.031	0.035
b	0.250	0.350	0.010	0.014
c	0.080	0.150	0.003	0.006
D	1.200	1.400	0.047	0.055
E	1.600	1.800	0.063	0.071
E1	2.550	2.750	0.100	0.108
L	0.475 REF.		0.019 REF.	
L1	0.250	0.400	0.010	0.016
θ	0°		8°	

### Suggested Pad Layout

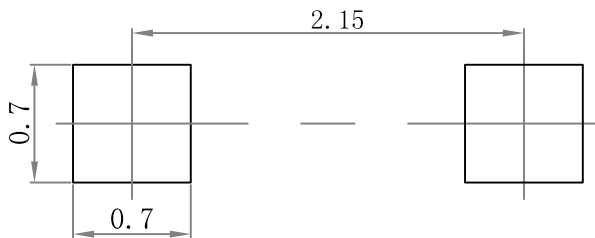

Note:

1. Controlling dimension: in/millimeters.
2. General tolerance:  $\pm 0.05$ mm.
3. The pad layout is for reference purposes only.

### PACKAGE SPECIFICATIONS

Package	Reel Size	Reel DIA. (mm)	Q'TY/Reel (pcs)	Box Size (mm)	QTY/Box (pcs)	Carton Size (mm)	Q'TY/Carton (pcs)
SOD-323	7'	178	3000	183×188×80	45,000	386×265×215	180,000