

SOT-23 Plastic-Encapsulate TVS/ESD Protection Diodes

DESCRIPTION

ESD0502TL is an ultra-low capacitance Transient Voltage Suppressor (TVS) designed to provide electrostatic discharge (ESD) protection for high-speed data interfaces. With typical capacitance of 0.2pF (I/O to I/O) only, ESD0502TL is designed to protect parasitic-sensitive systems against over-voltage and over-current transient events. It complies with IEC 61000-4-2 (ESD), Level 4 ($\pm 15\text{kV}$ air, $\pm 8\text{kV}$ contact discharge), IEC 61000-4-4 (electrical fast transient - EFT) (40A, 5/50 ns), very fast charged device model (CDM) ESD and cable discharge event (CDE), etc.

ESD0502TL uses small SOT-23 package. Each ESD0502TL device can protect two high-speed data lines. The combined features of low capacitance, small size and high ESD robustness make ESD0502TL ideal for high-speed data port and high-frequency line applications. The low clamping voltage of the ESD0502TL guarantees a minimum stress on the protected IC.

Features

- ◆ Peak Power Dissipation : 60W (8/20 μs)
- ◆ Transient protection for high speed data lines
- ◆ IEC61000-4-2 (ESD) $\pm 15\text{kV}$ (air), $\pm 8\text{kV}$ (contact)
- ◆ IEC61000-4-4 (EFT) 40A (5/50ns)
Cable Discharge Event (CDE)
- ◆ Small package (2.9mm \times 2.4mm \times 1.0mm)
- ◆ Protect two data lines
- ◆ Low clamping voltage
- ◆ Low Capacitance :0.2pF Typical (I/O - I/O)
- ◆ Low leakage current

Pin Configuration

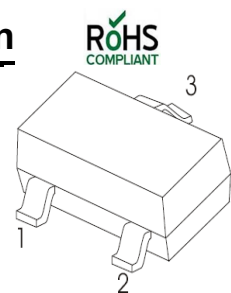

Circuit Diagram

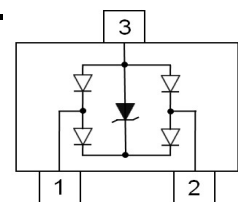

Mechanical Characteristics

- ◆ Package: SOT-23
- ◆ Flammability Rating: UL 94V-0
- ◆ Terminal: Matte tin plated.
- ◆ High temperature soldering guaranteed:
260 $^{\circ}\text{C}$ /10s
- ◆ Marking: 52L
- ◆ Packaging: Tape and Reel

Applications

- ◆ Serial ATA
- ◆ Desktops, Servers and Notebooks
- ◆ PCI Express
- ◆ MDDI Ports
- ◆ USB Data Line Protection
- ◆ Display Ports
- ◆ Digital Visual Interfacs (DVI)

Absolute Maximum Ratings ($T_A=25^{\circ}\text{C}$ unless otherwise specified)

Parameter	Symbol	Value	Unit
Peak Pulse Power(8/20us)	PPP	60	W
ESD per IEC 61000-4-2 (Air)	VESD	± 20	KV
ESD per IEC 61000-4-2 (Contact)		± 20	
Operating Temperature	T_{OPT}	-55 to +125	$^{\circ}\text{C}$
Storage Temperature	T_{STG}	-55 to +150	$^{\circ}\text{C}$
Lead Solder Temperature – Maximum (10 Second Duration)	T_L	260(10 sec.)	$^{\circ}\text{C}$

**Electrical Characteristics (T_A=25°C unless otherwise specified)**

Symbol	Parameter	Test Condition	Min	Typ	Max	Units
V _{RWM}	Reverse Working Voltage	I/O to GND			5.0	V
V _{BR}	Reverse Breakdown Voltage	I _T = 1mA Between I/O and GND	6.0			V
I _R	Reverse Leakage Current	V _{RWM} = 5V Between I/O and GND			100	nA
V _C	Clamping Voltage	I _{PP} = 1A, t _p = 8/20μs Between I/O and GND			10	V
		I _{PP} = 4A, t _p = 8/20μs Between I/O and GND			15	V
V _F	Forward Voltage	I _T = 10mA Between I/O and GND			1.2	V
C _T	Total Capacitance	V _R = 0V, f = 1MHz Between I/O and GND		0.4		pF
		V _R = 0V, f = 1MHz Between I/O and I/O		0.2		pF

The above data are for reference only.



ELECTRICAL CHARACTERISTICS CURVE

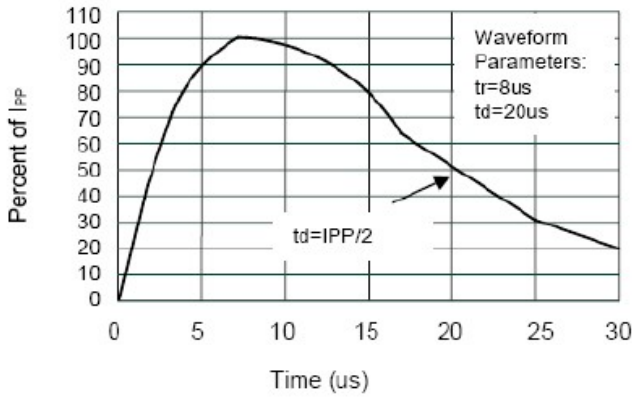

Pulse Waveform

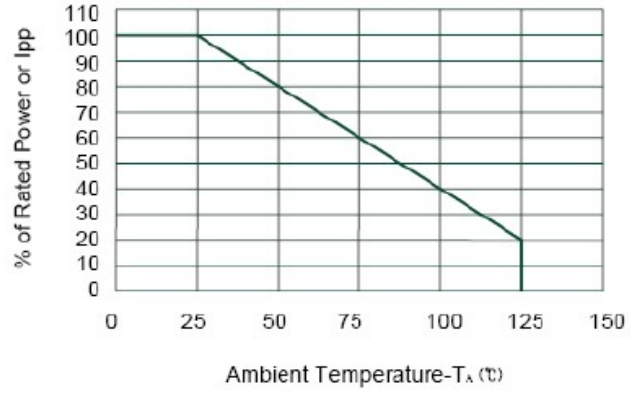

Power Derating Curve

The curve above is for reference only.

Outline Drawing

SOT-23 Package Outline Dimensions

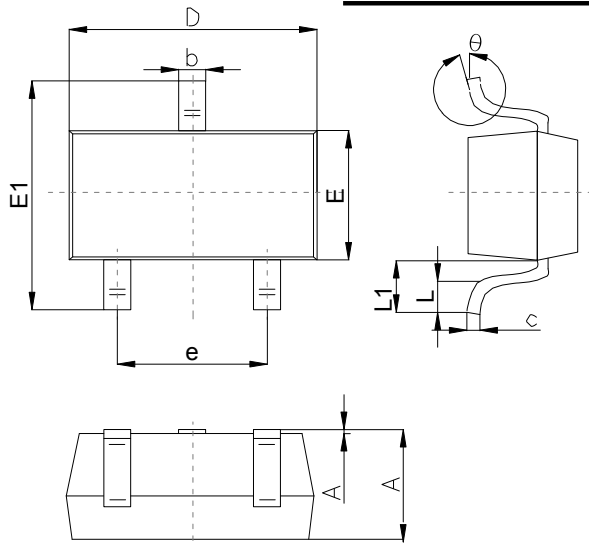

Symbol	Dimensions In Millimeters		
	Min	Typ	Max
A	0.89	1.00	1.40
A1	0.01	0.06	0.10
b	0.37	0.44	0.50
c	0.09	0.13	0.20
D	2.80	2.90	3.10
E	1.20	1.30	1.60
E1	2.10	2.40	2.80
e	1.78	1.90	2.04
L	0.10		0.30
L1	0.35	0.54	0.69
θ	0°		10°

Suggested Pad Layout

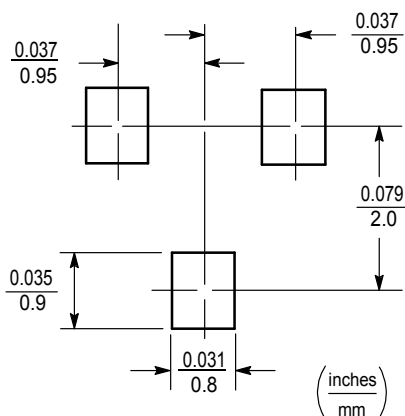

Note:

1. Controlling dimension:in/millimeters.
2. General tolerance: $\pm 0.05\text{mm}$.
3. The pad layout is for reference purposes only.

SOT-23 Tape and Reel

SOT-23 Embossed Carrier Tape

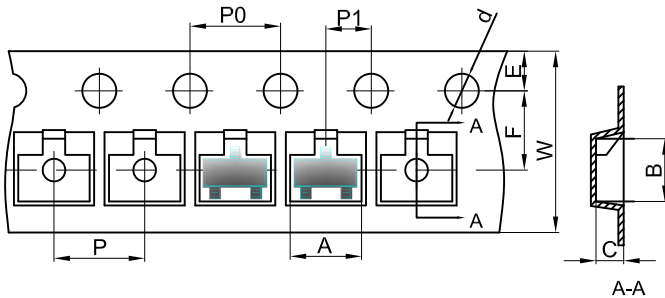

Packaging Description:

SOT-23 parts are shipped in tape. The carrier tape is made from a dissipative (carbon filled) polycarbonate resin. The cover tape is a multilayer film (Heat Activated Adhesive in nature) primarily composed of polyester film, adhesive layer, sealant, and anti-static sprayed agent. These reeled parts in standard option are shipped with 3,000 units per 7" or 17.8cm diameter reel. The reels are clear in color and is made of polystyrene plastic (anti-static coated).

Dimensions are in millimeter										
Pkg type	A	B	C	d	E	F	P0	P	P1	W
SOT-23	3.15	2.77	1.22	Ø1.50	1.75	3.50	4.00	4.00	2.00	8.00

SOT-23 Tape Leader and Trailer

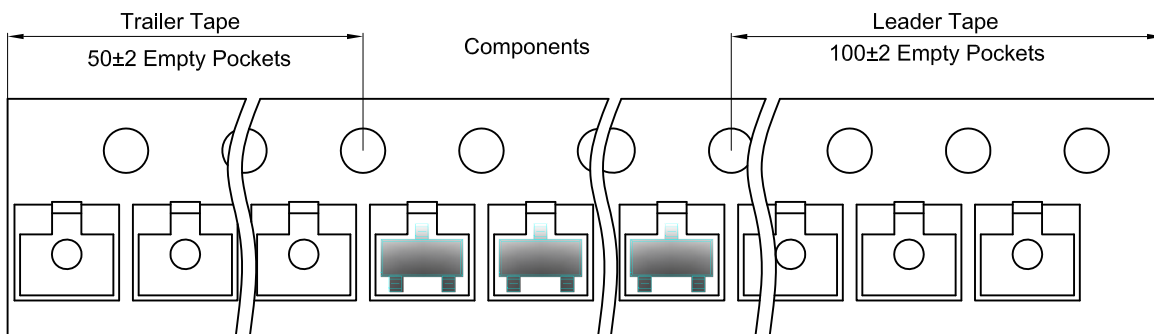

SOT-23 Reel

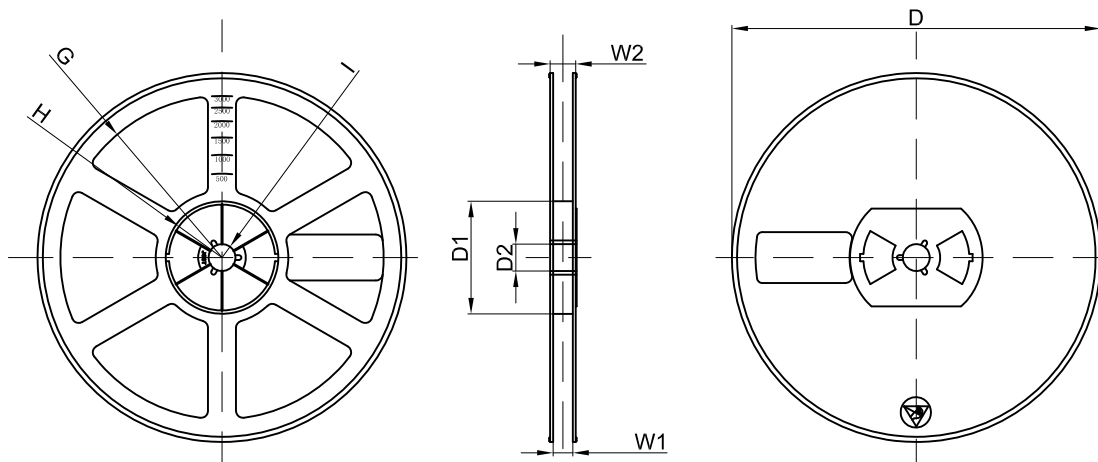

Dimensions are in millimeter								
Reel Option	D	D1	D2	G	H	I	W1	W2
7" Dia	Ø178.00	54.40	13.00	R78.00	R25.60	R6.50	9.50	12.30

REEL	Reel Size	Box	Box Size(mm)	Carton	Carton Size(mm)	G.W.(kg)
3000 pcs	7 Inch	45,000 pcs	203×203×195	180,000 pcs	438×438×220	